

OVERVIEW

LUFF TRACK - The plastic luff track section

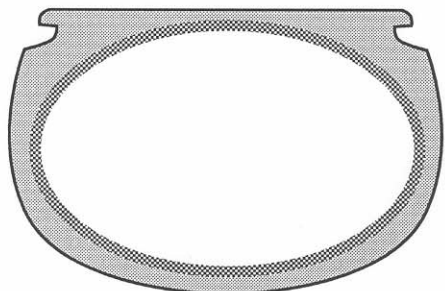

COMPTIP SECTION - The upper mast is made as a fiberglass tube that is coated with a black putty material. The tube is hollow except for a plug of foam material at the top and the bottom.



The plastic luff track section snaps onto the Comptip section.

The design causes the track to grip the Comptip section more as more pressure attempts to pull the sail out of the luff track.

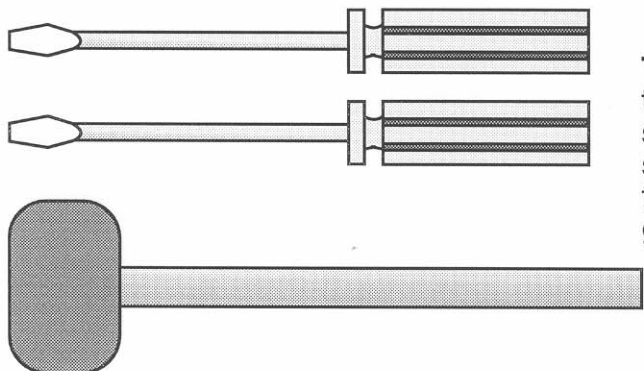
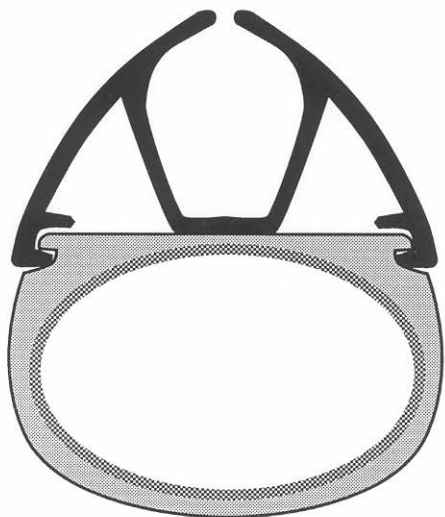

TOOLS FOR REPLACEMENT - To replace the luff track you will need two small "blade" or "slot" screwdrivers and a rubber mallet helps. The screwdrivers should have thin blades that can be forced between the Luff track and the Comptip groove.

REMOVAL

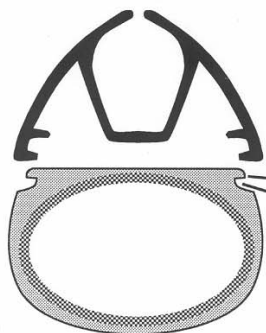

LUFF TRACK REMOVAL - To remove the Luff track from the Comptip you will need to pry the corner of the track out from the Comptip groove using the blade screw drivers. Caution is required that you do not chip the Comptip lip.

Corner of Luff track
Comptip lip (Fragile, Do not chip)
Comptip groove

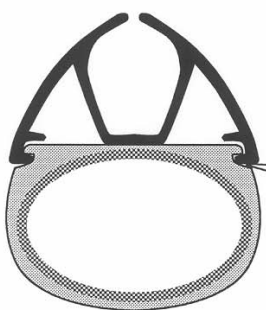

Starting at one end of the Luff track, place the tip of one of the screwdrivers between the Luff track and the Comptip as shown. Work the screw driver up and down while pressing into the groove. This will allow you to hook the track edge and pry out from under the lip. Be very carefull not to catch the lip and chip it. (A chipped lip will not hold the Luff track as well but does happen from time to time and may be no problem at all.)

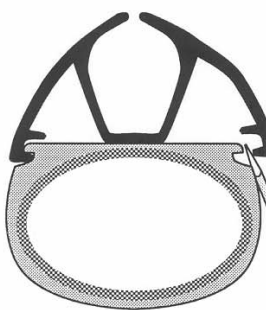

Pry the corner away from the Comptip groove. Once again, Be careful not to chip the lip. Slide the screw driver deeper to hold the track away from the groove. Place the second screwdriver about 6 inches farther down the track and repeat the process. Repeat again with the first screw driver farther down the track until you can peel the track away from the mast by hand. If you can grip the track edge by hand, pull straight away from the mast and towards the opposite side a little.

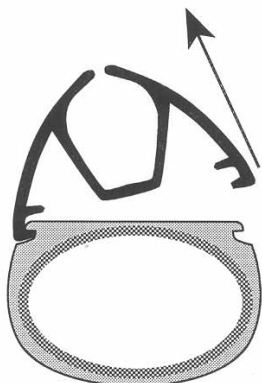

Grip Luff track and pull away from the mast.

REPLACING

INSTALLING THE LUFF TRACK - Cut the track to fit the length. Fair or smooth the ends so they do not catch the sail as it is raised or lowered.

Place one side along the Comptip and insert the edge into the groove.

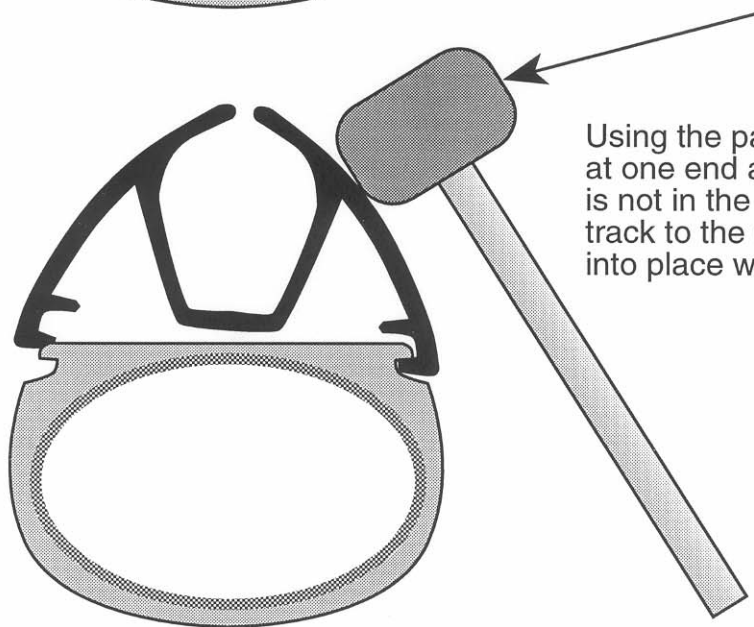
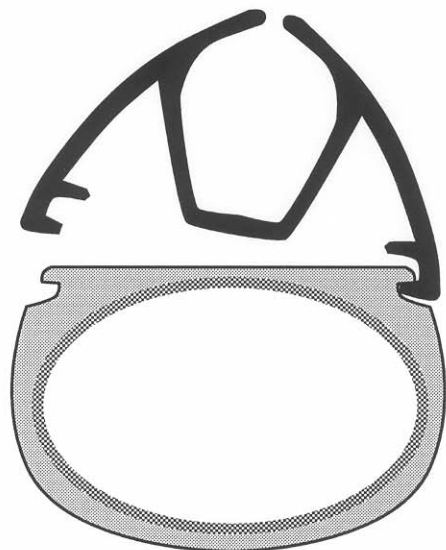

Using the palm of your hand or a soft mallet, start at one end and tap the track towards the side that is not in the groove. Work along the length of the track to the opposite end. The track should snap into place without great effort.

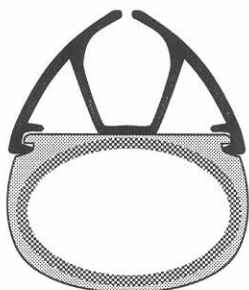

Correctly installed track.