



Hobie Mirage
iTrek Kayak Manual

In 1950, Hobie's dream was born in his parents' garage when he decided to apply his love of woodworking to the sport of surfing. Dad backed out the Buick... Hobie carved out his very first surfboard...

Hobie's business of fun had begun.

Anatomy	5
Assembly	6
Inflating and Deflating	8
MirageDrive®.....	10
Seat	12
On the Water	14
Storage and Transportation.....	18
Maintenance and Care	23
Kick-Up Adjustment	25
Safety	26
Warranty	28
Accessories	29

Online video is available at
www.hobie.com/support/products

Please read through the instruction manual before using this
product

- 1. Hull
- 2. MirageDrive
- 3. Seat
- 4. Steering
- 5. Cassette Plug
- 6. Repair Kit
- 7. Air Pump
- 8. Electric and Manual Pump
- 9. Cup Holder
- 10. 7/32 Hex Wrench

iTrek 11 shown here,
models may vary.

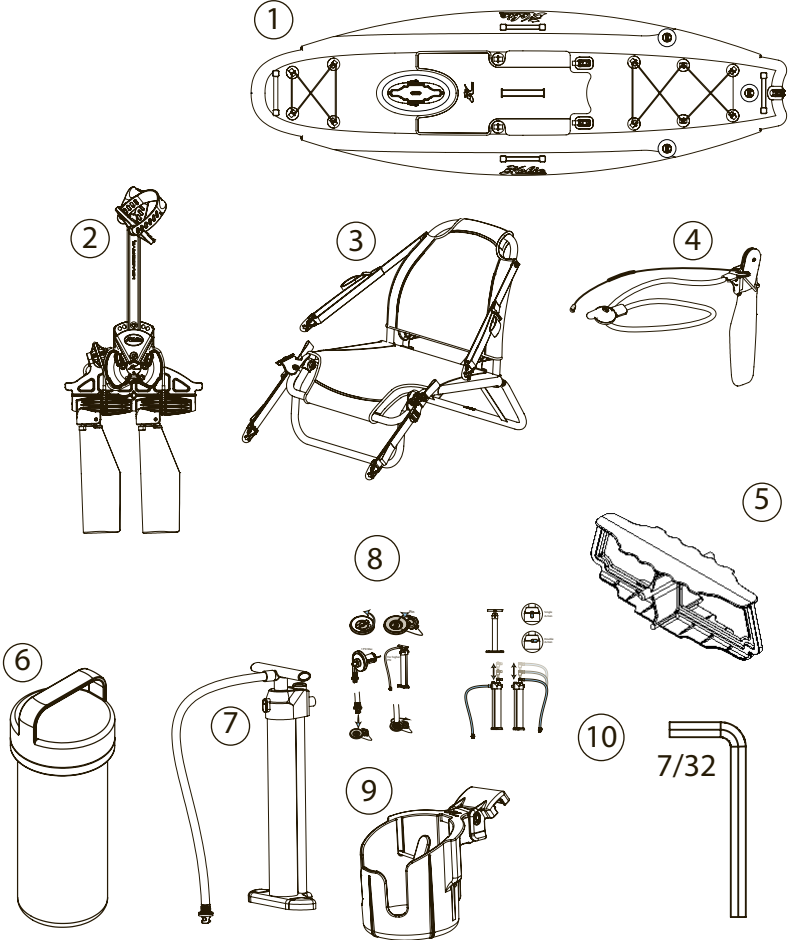

MirageDrive Cranks

Depending on the Mirage kayak model, cranks may or may not require assembly.

①

Insert the Left and Right crank into drums while depressing button at top.

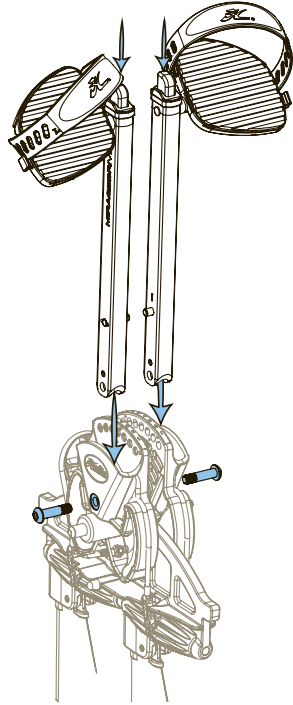

②

Tighten crank bolt all the way (snug not tight) using the included $7/32$ " wrench.

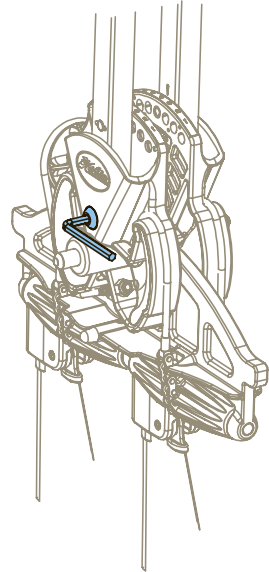

iTrek 11 shown here,

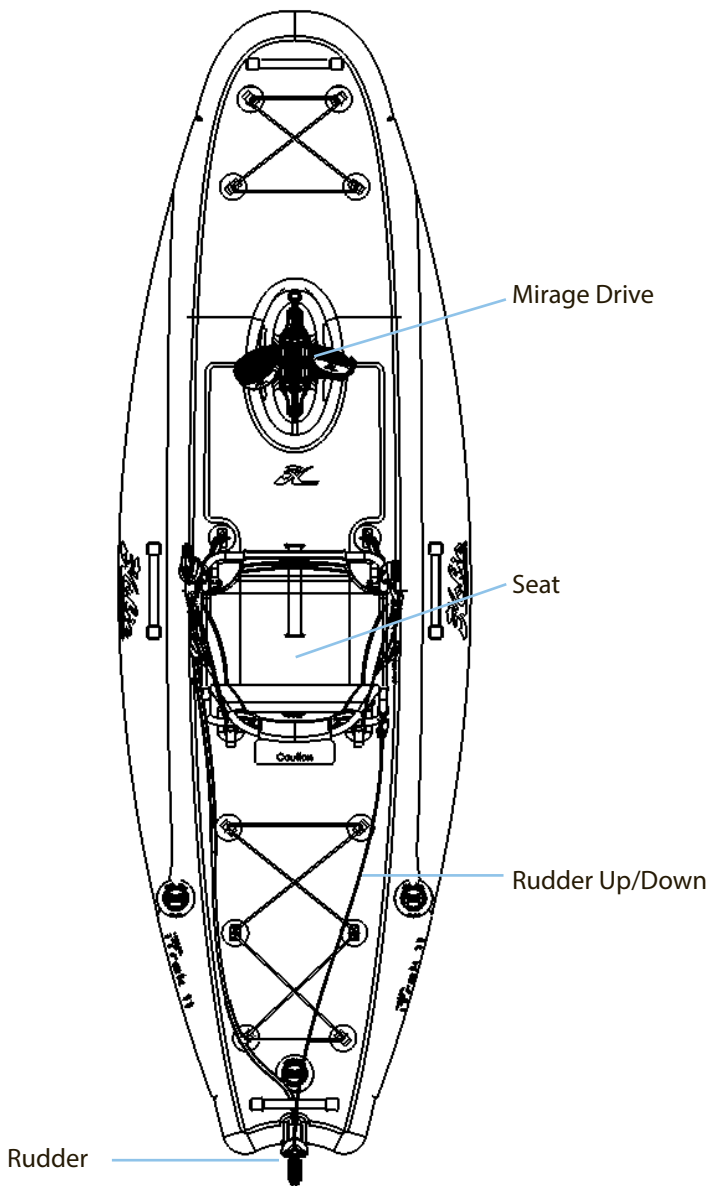

Inflating the Kayak

①

Locate the air valve(s) on your kayak near the stern.

Unscrew the cover of the valve and make sure the pin is "up".

If it does not spring up it is in the "down" position. To unlock the pin from the "down" position push down on the pin and turn it counter-

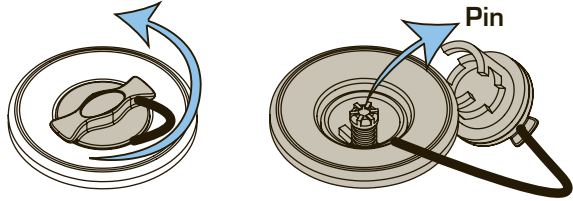

②

Your kayak comes with two pumps.

The electric pump will inflate your kayak to 1 PSI Max. This is NOT enough pressure to use the kayak.

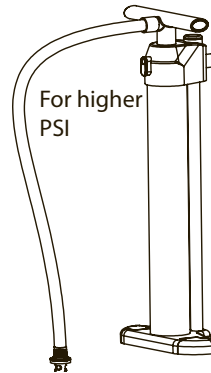
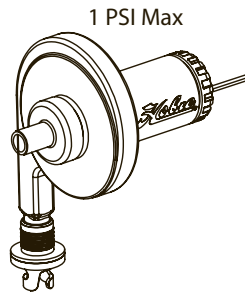

For higher pressure, use the manual hand

③

Line up the nozzle of the pump with the valve. Make sure the pin is in the "up" position. Plug in the nozzle and 1/4 twist to lock the nozzle to the valve. Begin

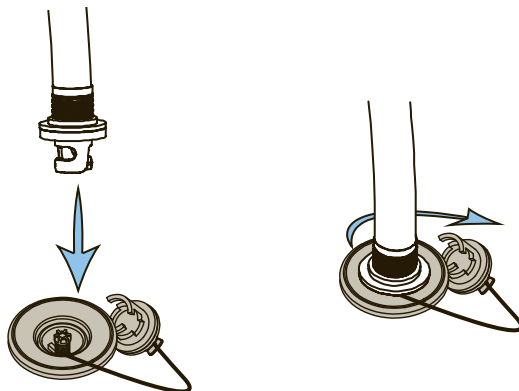

Pump

④

Adjust the lever on the back side of the pump for more efficient pumping.

Double action is for more air volume and lower pressure.

Single action is for less air volume and higher pressure.

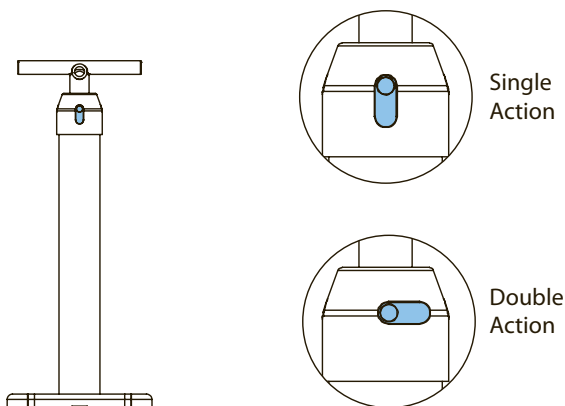

Deflating the Kayak

⑤

Switch the hose on the pump to the connection on the body of the pump.

Switch the nozzle to the top of the electric pump.

Connect nozzle to the valve on kayak to deflate.

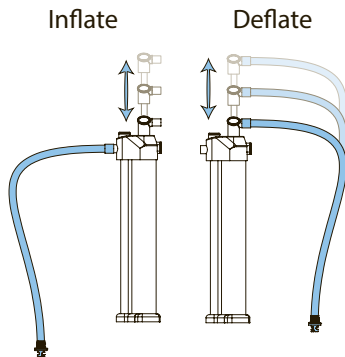

Inflate

Deflate

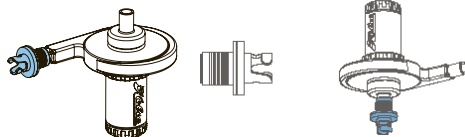

Pressure Warning

⑥

It is important to never inflate your kayak past the recommended pressure. Pressure recommendations are found around the air

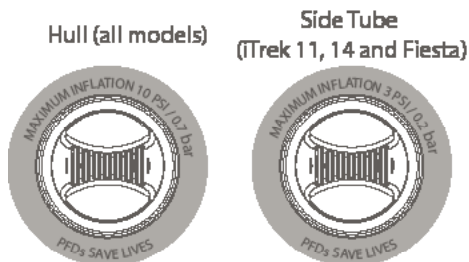

Installation

①

Lower drive straight down making sure the spine is level.

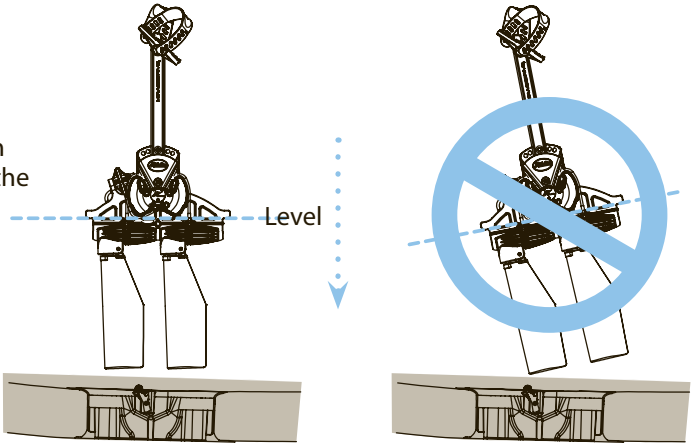

②

Press down and lock drive into Click and Go's. The drive locks automatically when installed.

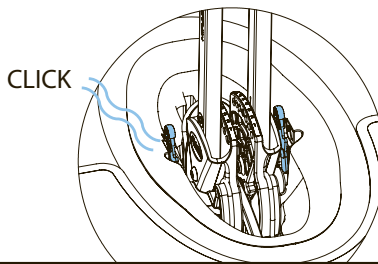

Removal

①

Pull back each Click and Go lever in unison.

②

Lift drive straight up.

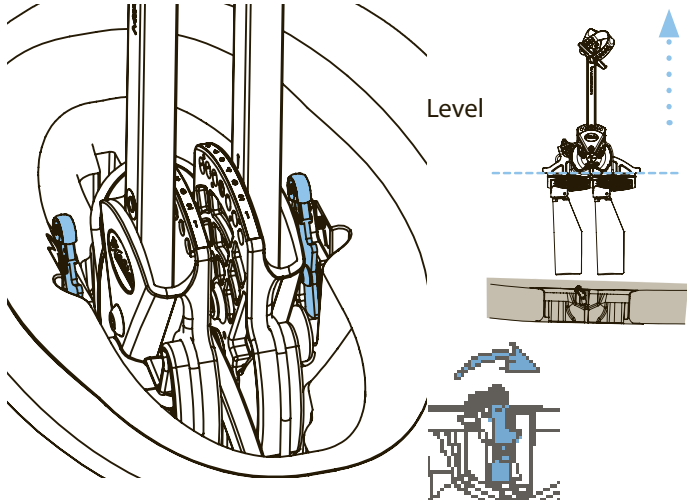

Adjustment

①

Press the adjuster button at top of crank.

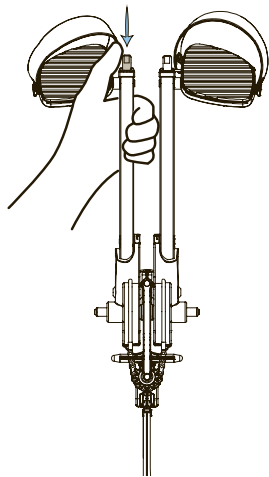

Squeeze

②

Adjust cranks by rotating and clicking them into the desired position. Make sure both cranks are in the same position number.

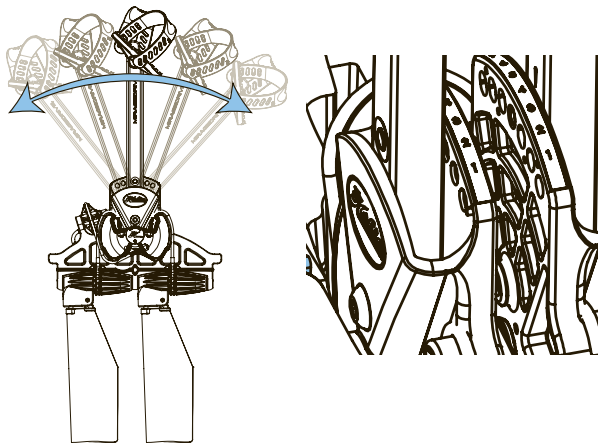

③

With both feet on the pedals and together (fins straight down), your knees should be comfortably bent and not over crunched or extended.

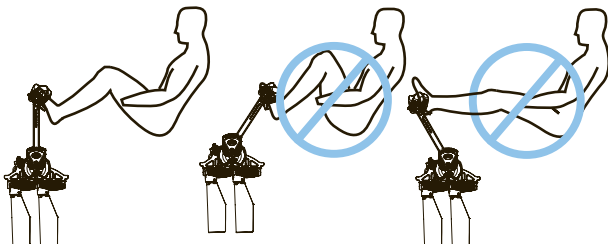

Installation

There are two connection points on the kayak to secure the seat.

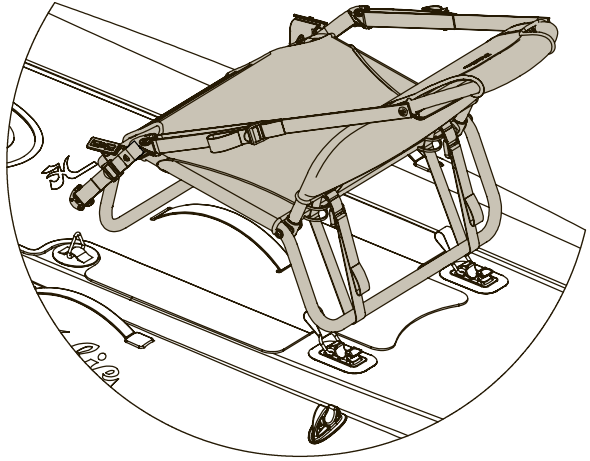

①

Connect the rear seat bottom frame into the seat holders on the back of the kayak.

Push down on the seat until it snaps into the holders.

Secure by stretching the shock cord over the seat bottom frame and looping the shock cord

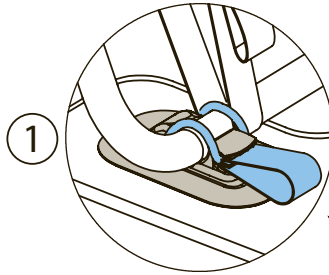

①

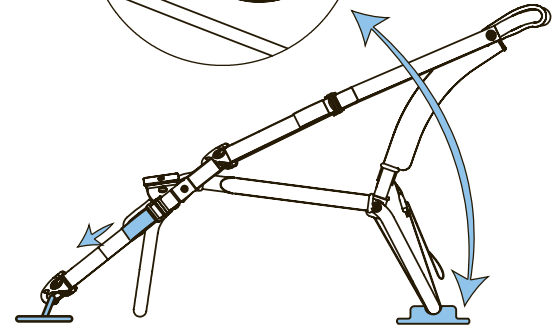

②

Connect the hooks on the left and right straps that hang off the front of the seat to the D-Rings on the kayak.

Pull the Left and Right straps tight to secure the seat in

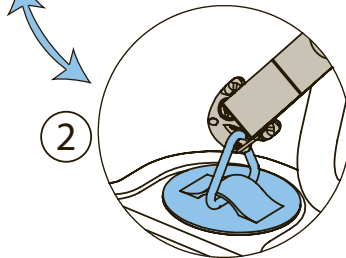

②

Adjustment

①

Connect the hooks on the left and right straps that are fixed to the seat back frame to the loops on the left and right side of the seat bottom frame.

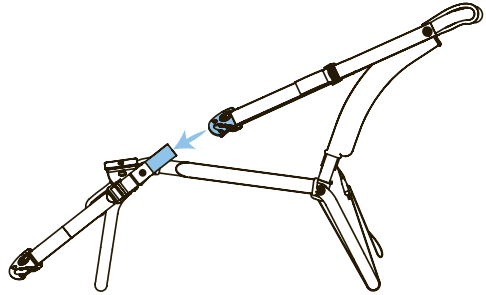

②

Loosen the webbing through the plastic buckle to recline the seat.

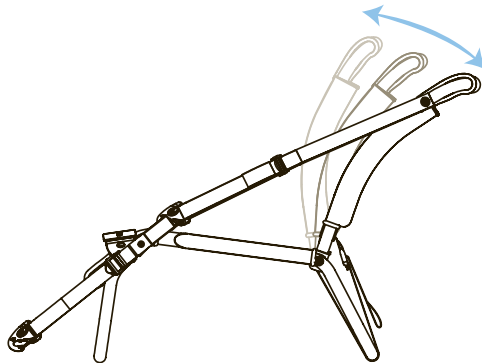
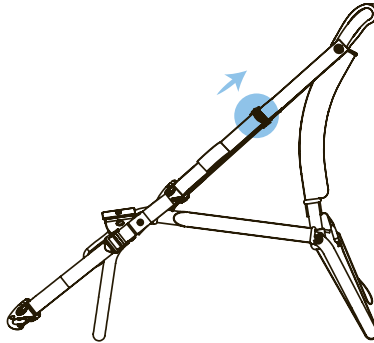

③

Pull the webbing tabs on the left and right straps to adjust the seat more upright.

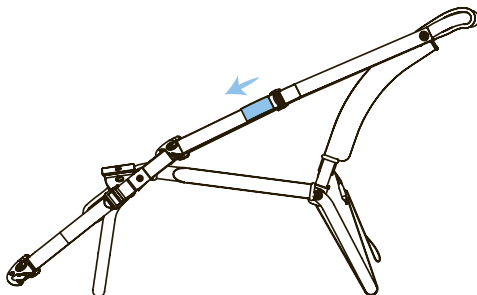

MirageDrive Operation

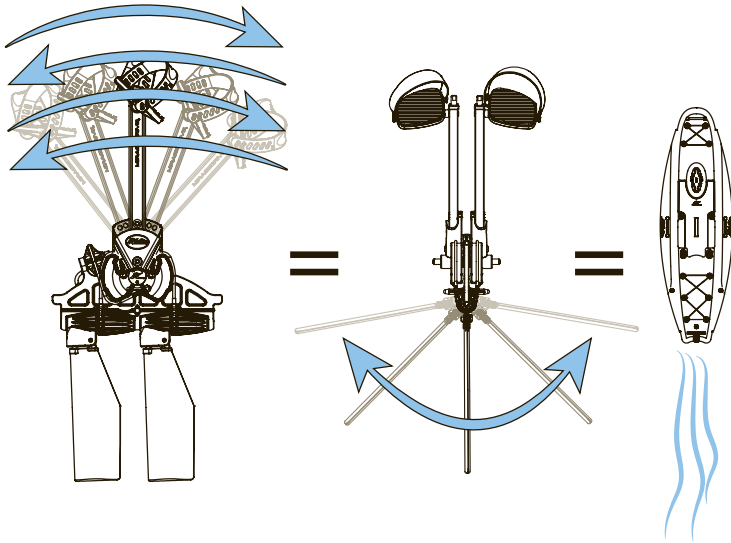

Shallow
Water
and
Beaching

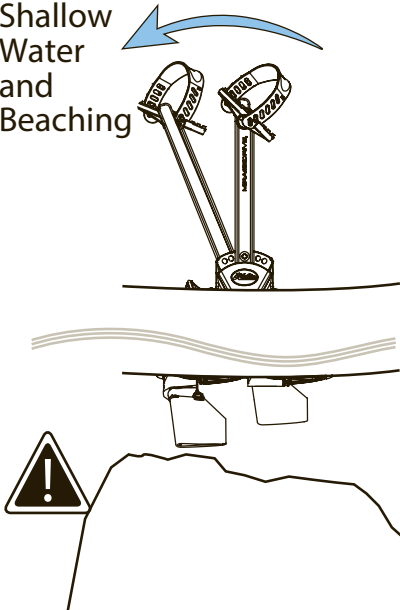

Press either pedal forward in shallow water to raise fins. Pressing one pedal fully forward will orient the fins with the kayak underside.

Kick Up Fins

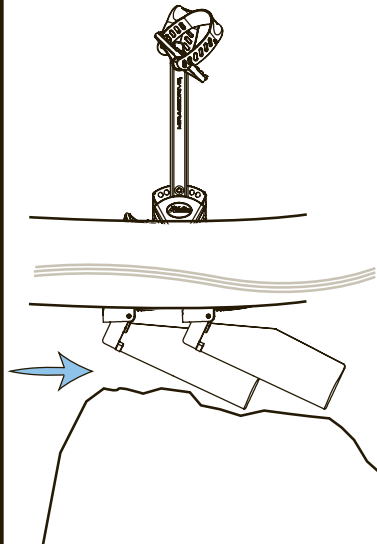

The kick-up fins will automatically retract backwards when coming in contact with any object and resume their normal position when you pedal.

Rudder

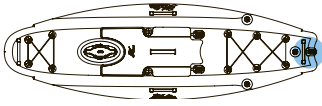

①

Align the track on the rudder system with the track on the gudgeon that is mounted to the back of the kayak.

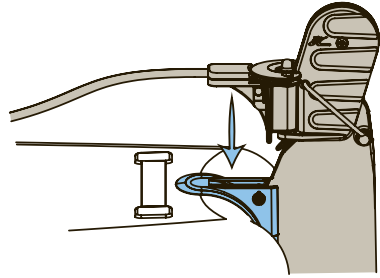

②

Slide the rudder track into the gudgeon track.

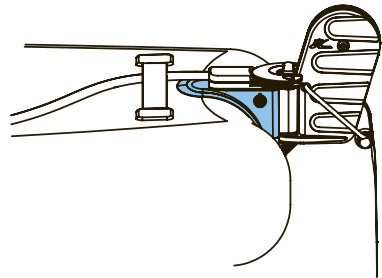

③

To remove the rudder pull the red locking knob out while pulling the rudder

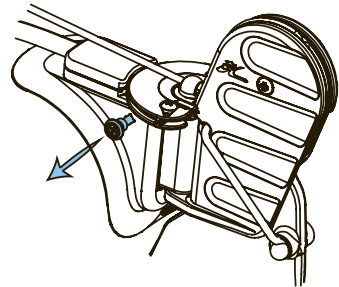

Your rudder pin is designed to break under high loads. An extra pin is stored inside the pocket on your seatback.

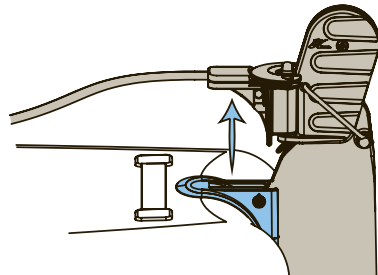

Steering

①

There are steering tracks located on both sides of the seat. Choose which side is best for

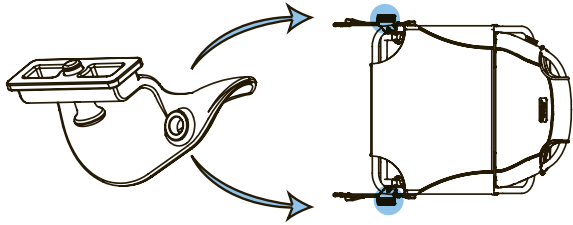

②

Slide the steering handle onto the track over the lock pin. The pin will click into place.

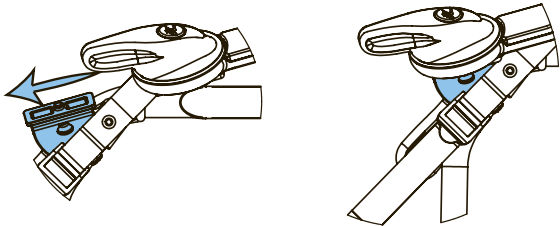

③

To remove the steering handle, pull down on the red knob located on the underside of the steering track and slide the handle off the track.

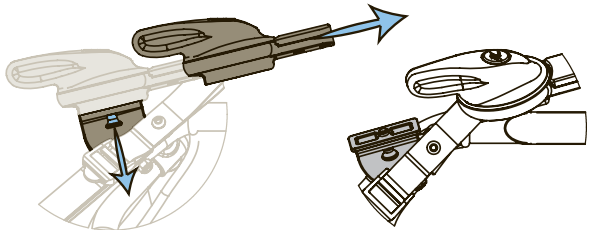

④

Point the steering handle in the direction you would like to travel.

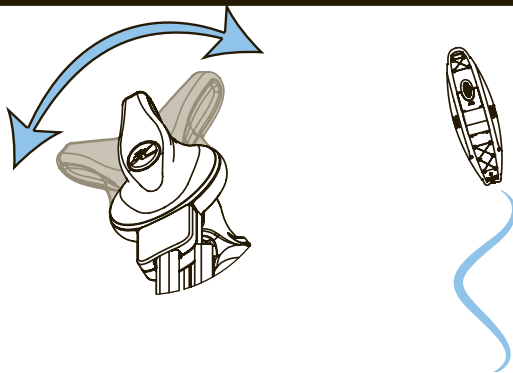

Rudder UP/DOWN

①

Connect the hook on the rudder up/down line to the padeye mounted on the back of the seat bottom.

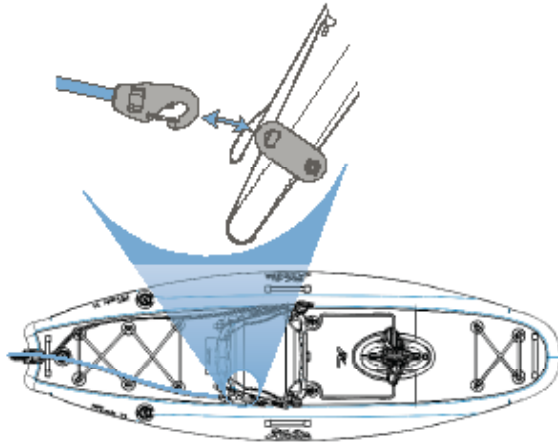

②

Once the up/down line is connected, pull up on the line to flip the rudder down and back up.



Cup Holder

Place on the opposite side of the steering handle

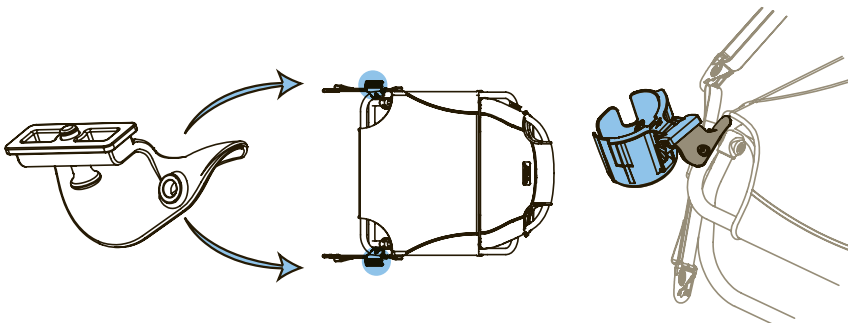

Cart

The cart should be used for transportation purposes only and not as a storage

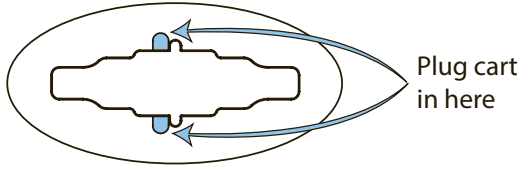

①

Turn kayak on its side and line up the two prongs on the cart and the two receivers on the bottom of the Mirage well.

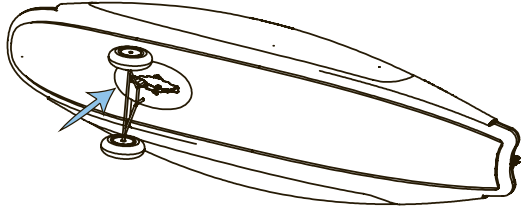

②

Plug the cart into the well once the cart is lined up with the receivers.

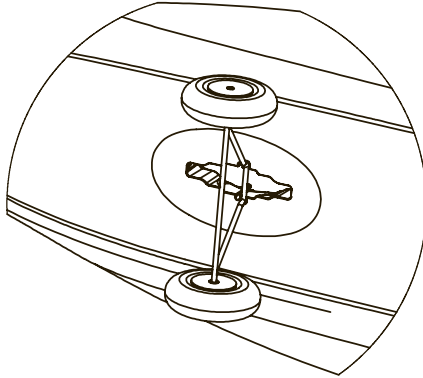

Note:

Rough terrain and jumping over curbs could result in damaging the Mirage well and plug-in cart.

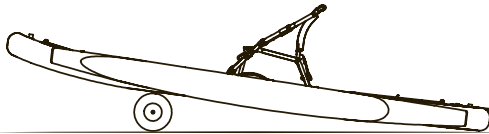

Folding iTrek 9

Note:

Folding directions are also featured on the inside cover of the storage bag

MIRAGE[®]
iTrek 9
U L T R A L I G H T

Note: For best results folding, pump out all air from kayak.

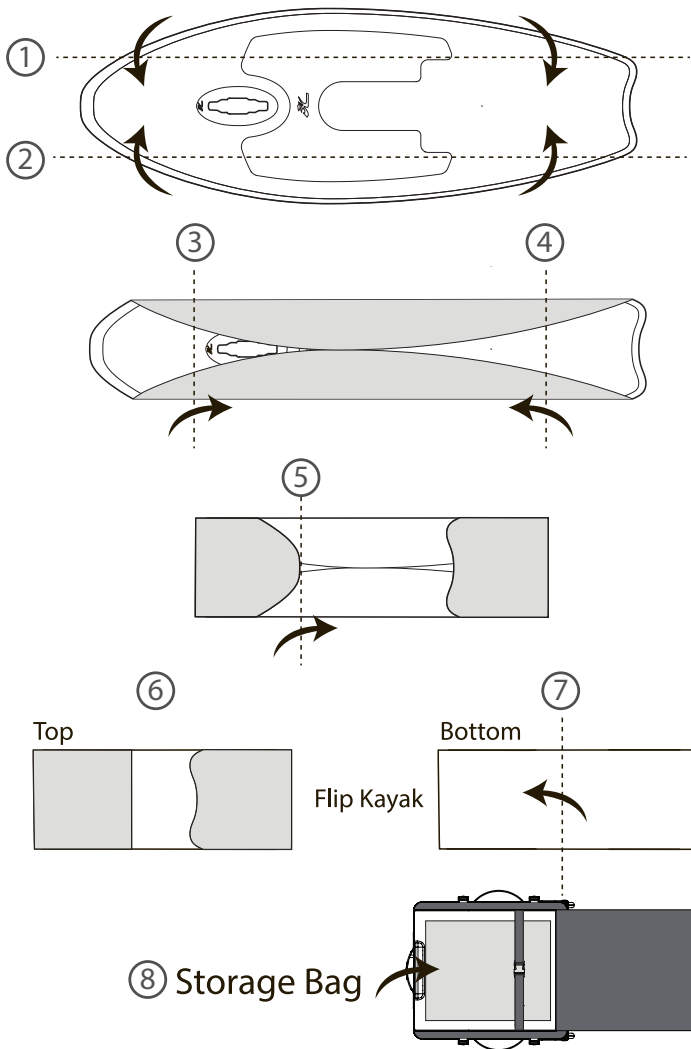

Folding iTrek 11

Note:

Folding directions are also featured
on the inside cover of the storage bag

MIRAGE.

iTrek 11

Note: For best results folding,
pump out all air from kayak.

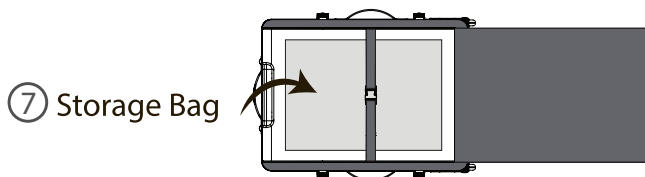
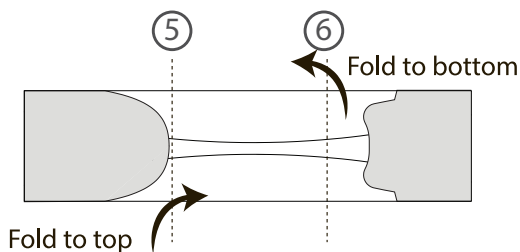
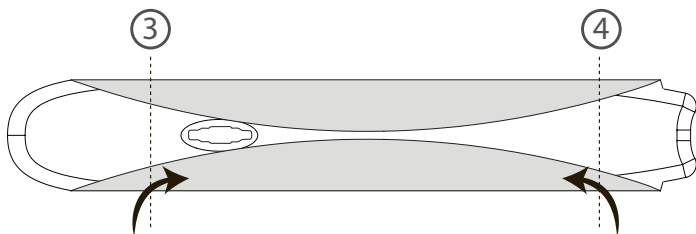
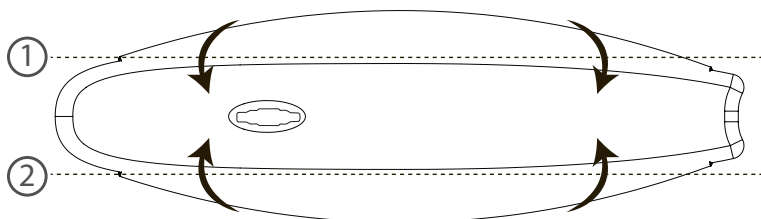

Folding iTrek 14

Note:

Folding directions are also featured
on the inside cover of the storage bag

MIRAGE[®]

iTrek 14
D U O

Note: For best results folding,
pump out all air from kayak.

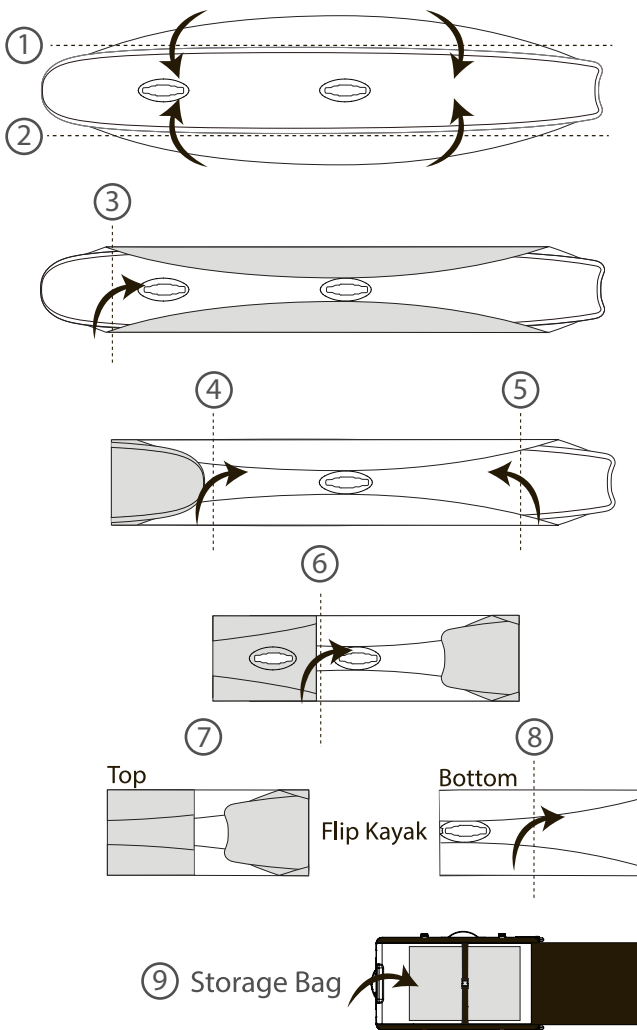

Folding Fiesta

Note:

Folding directions are also featured on the inside cover of the storage bag.

MIRAGE

FIESTA

Note: For best results folding, pump out all air from kayak.

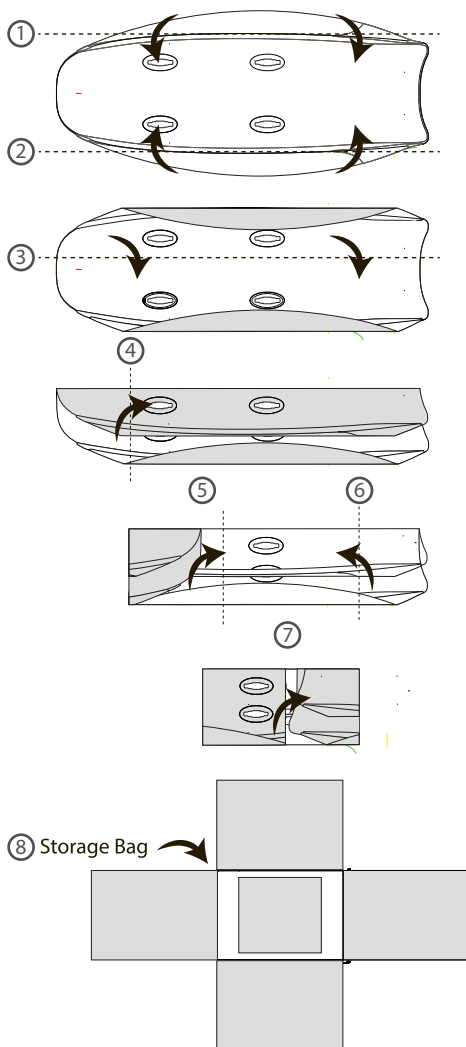

MirageDrive Regular Maintenance

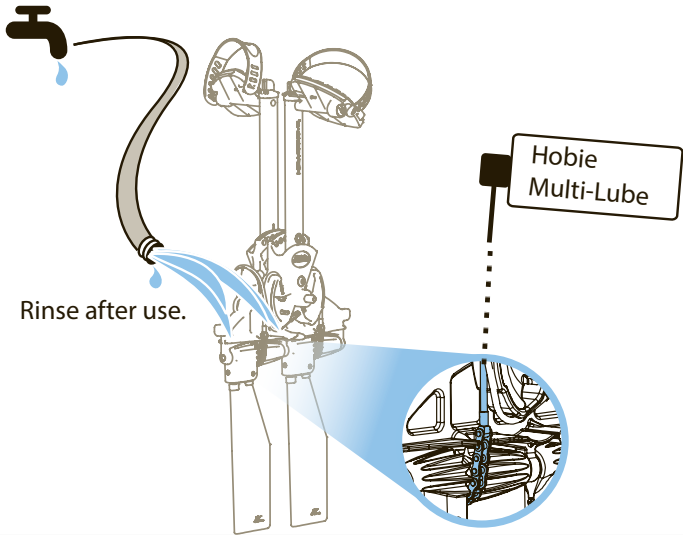

Checking Cable Tension

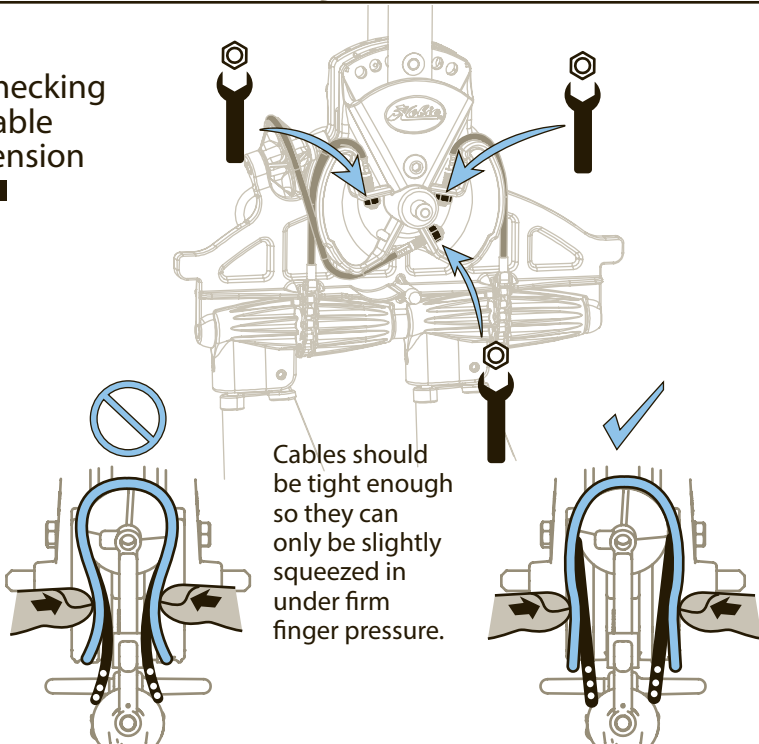

Visit the “support” section at hobie.com for information on the MirageDrive.

Rudder Tuning

①

Loosen the left and right screws so the steering cables are free to move

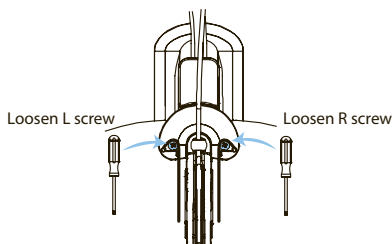

②

Align the steering handle straight.

Tip: Fully tighten the screw under the steering handle to keep the handle from turning during the adjustment.

Align steering handle pointing straight



③

Starting with the left or right side, feed the cable under the screw head on the rudder drum. Pull the cable so there is no slack until the cable is taut. Tighten the screw to lock the cable.

Align rudder pointing straight

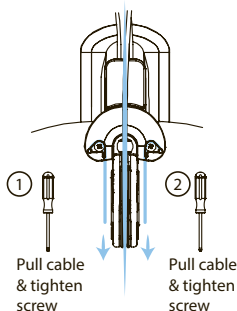

Repeat for opposite side.

Loosen the screw under the steering handle 1/4 turn.

Store out of Weather

WARNING: Do not store in humidity, it can cause damages to the inflatable. Heat and direct sunlight can raise pressure over the inflation limit.

Store your kayak in the rolling bag or inflated in a cool, dry environment out of the elements.

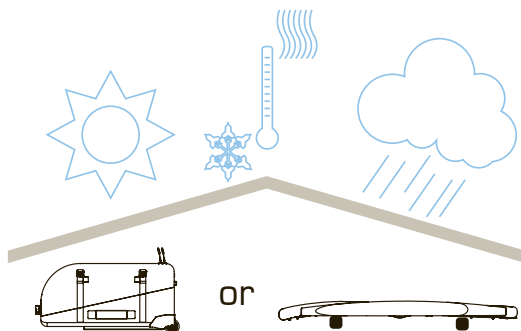

Kick-Up Fin Adjustment

If the fins do not stay locked into position and feel loose, you'll need to adjust the kick-up set screw.

①

The set screw is located in the housing at the base of the fin.

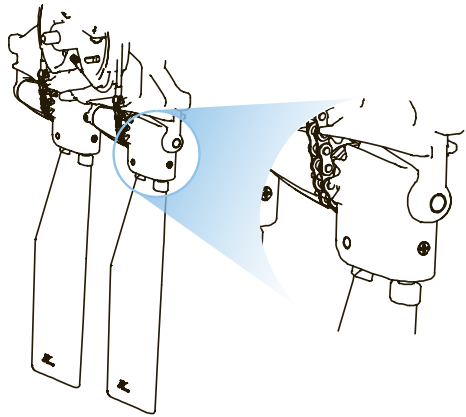

②

Make sure that the fin is completely engaged into the sprocket.

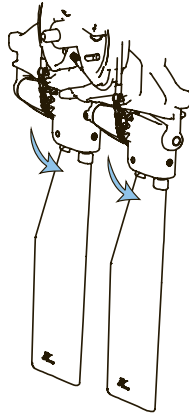

③

Tighten the screw 1/4 turn at a time until the set screw just touches the fin.

Test the fin by moving it in and out of the kick-up position to determine if it needs to be tightened or loosened.

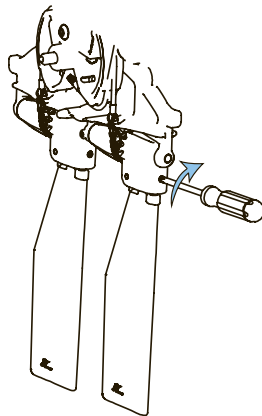

Checklist

Please read through the owner's information package and manual prior to using this product.

The user of this product acknowledges both an understanding and assumption of risk involved in paddle/pedal sports. Consult your physician prior to beginning.

Always:

- Wear a Coast Guard approved personal flotation device (life jacket).
- Dress appropriately for weather conditions; cold water and/or weather can result in hypothermia; apply sunscreen and other sun protective clothing.
- Check your equipment prior to each use for signs of wear or failure.
- Tie a safety leash to your paddle and MirageDrive
- Scout unfamiliar waters.
- Be aware of river water levels, tidal changes, wind conditions, obstacles in and above the water and weather changes.
- Carry a pump
- Always carry the paddle provided with the boat.

Never:

- Never go alone and always file a float plan.
- Never go in flood and/or fast moving water conditions. Hobie kayaks are not designed for fast moving water.
- Never exceed your ability and be aware of your limitations.
- Never use alcohol or mind-altering drugs prior to or while using this product.
- Never over inflate your kayak.
- Never leave your kayak in a hot environment.

Shakedown Cruise

As with any new product, it is important that you become familiar with the boat and all its features. It is also important to determine that the boat is sound before long trips. We recommend that you do what we call a “shakedown cruise” when the boat is new, after shipping or transport, before long trips. This test is typically done in shallow, calm conditions where you can familiarize yourself with or test the boat before taking any long trips into open water. Things you should check or practice are:

- MirageDrive installation, adjustment and removal
- Rudder operation
- Inflating and Deflating the kayak
- Getting in and out of the boat from a capsized state

Getting into your Boat

If you fall out of your boat, stay with the boat. You should be properly wearing a life jacket/PFD which will keep you afloat. If the boat is upside-down, it will need to be turned over. To do this, reach across the bottom of the boat and grab the Hobie MirageDrive and pull the boat upright. Position yourself so your head is near the cockpit area of the boat and you are facing the boat. You will want to be between the seat and the footwell areas of the boat. Reach across the boat to the far edge with one hand. Place the other hand on the near-side rail, then kick with your feet, pulling yourself up and onto the boat. Roll over onto your backside toward the seat, which should place your backside in the seat. Sit up, swing your feet into the footwells and you’re ready to go.

Mirage Inflatable Cassette Plug

Your Hobie is shipped with a Mirage Cassette Plug. The plug is provided as standard equipment in the Mirage Kayak package. Insert the plug into the Mirage well when the MirageDrive is removed to provide added safety and to “fair” the bottom of the hull when paddling.

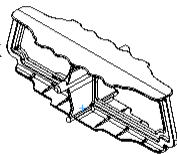

It is very important that you complete and send us your Warranty Registration Card as soon as possible.

This information enables Hobie Cat Company to contact you should there be important product information that needs to be shared with you in a timely manner. Please complete the Warranty Registration Card in your Owner's Packet, or take advantage of our online option at:

<http://www.hobie.com/product-registration>

or

Scan this QR code with your smart phone



If you have a question or issue with your Hobie product, please see your Authorized Hobie Kayak Dealer. They will assess the problem, assist with a repair and file a warranty claim with Hobie Cat Company if needed. All warranty claims must go through your Authorized Hobie Kayak Dealer. The Warranty Registration Card and Warranty Policies are included with each model in the Owner's Packet. Type in the address below to go to our dealer finder webpage.

All specs, colors, graphics and features are subject to change without notice. Please refer to the website for complete details.

<http://www.hobie.com/dealers>

i-Series Plug-In-Cart



Hobie Multi-Lube



Inflatable PFD



Hobie Boat Cleaner



Hobie UV Protectant



Accessories can be purchased on www.hobie.com

Enjoy the Ride!



Corporate Headquarters
Oceanside, CA USA

WWW.hobie.com