

HOBIE H14 / H16

REPLACEMENT HULL H16 WHITE - LEFT
25010001
REPLACEMENT HULL H16 WHITE - RIGHT
25020001

Decals -
12452161 "16" Silver
12452121 "Hobie Cat" Black
12451061 "Hobie" Diamond 36" Silver
12452000 Silver pin stripe (ft)

Older Decals -
12452160 "16" Silver
12451130 "Hobie" Red Each
12451021 "Hobie" Diamond 36" Red
12452000 Silver pin stripe (ft)

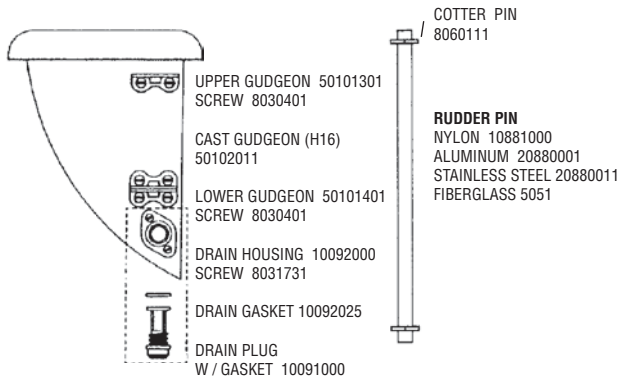
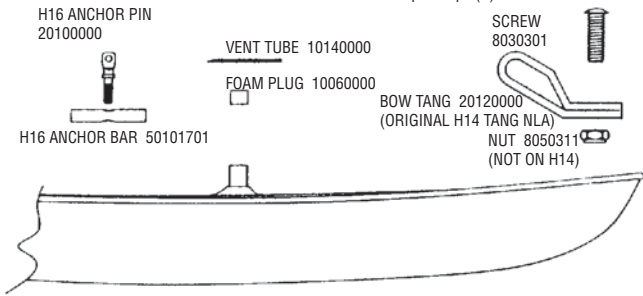

H14 / H16 TRAMPOLINE, SIDEBAR

H14 COMPLETE TRAMPOLINE
(Does not include lace lines)
1097XXXX
(XXXX = Color / See parts list for available options)

H16 COMPLETE TRAMPOLINE
(Does not include lace line)
2097XXXX
(XXXX = Color / See parts list for available options)

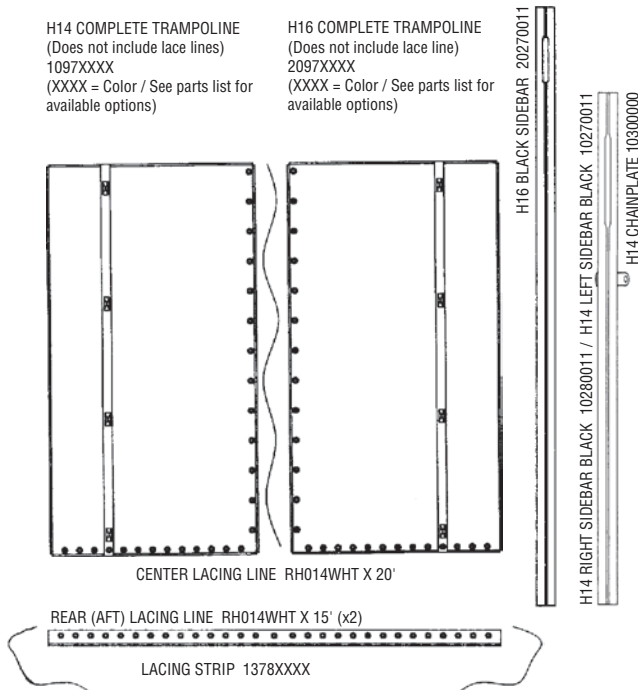

H14 / H16 FRONT CROSSBAR

H14 BLACK FRONT CROSSBAR W/MAST STEP 10131910
H16 BLACK FRONT CROSSBAR W/MAST STEP / INTEGRATED TRACK 25131910

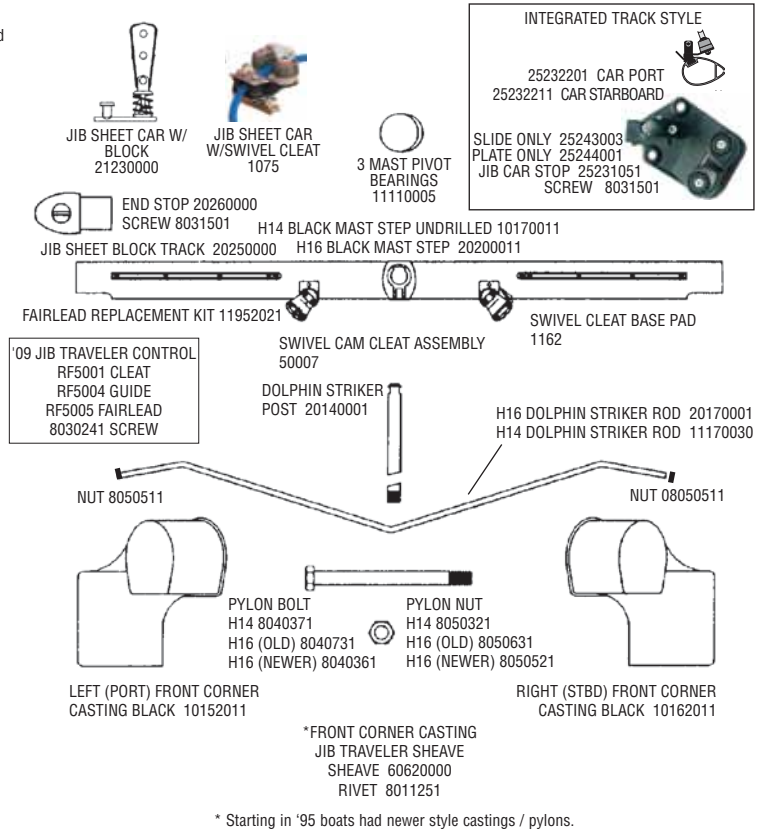

H14 / H16 REAR CROSSBAR

CROSSBAR EXTRUSION w/ INTEGRATED TRACK, REAR (AFT) WITHOUT CORNER CASTINGS, BLACK - INCLUDES CAR ACCESS PLATE
H16 25191911
H14 10191910
'94 AND NEWER CAR ACCESS PLATE 11810011

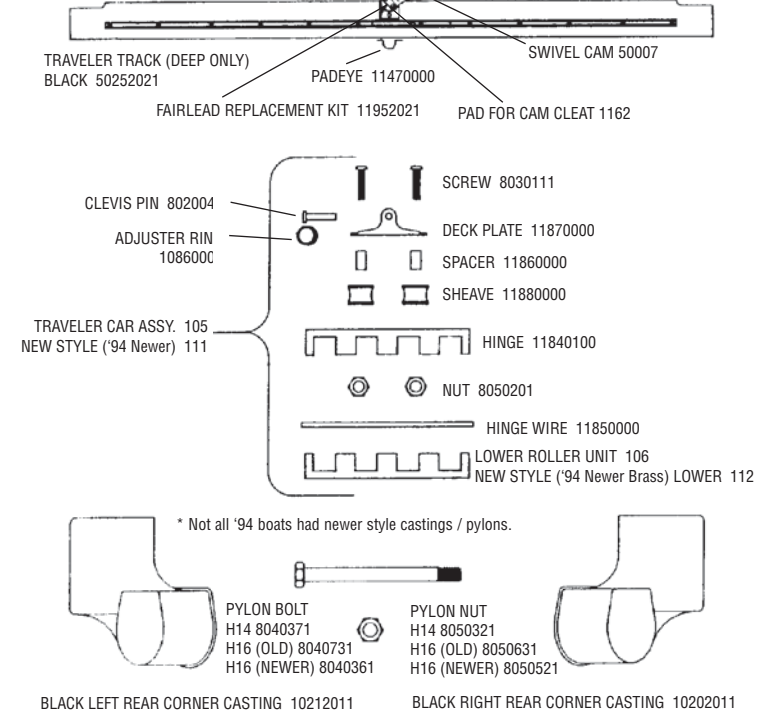

H14 / H16 RUDDER

* = SUB ASSEMBLY PART / INCLUDED WITH CASTING

MIRACLE CONNECTORS

TILLER ARM SWIVEL

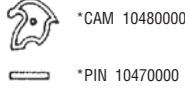
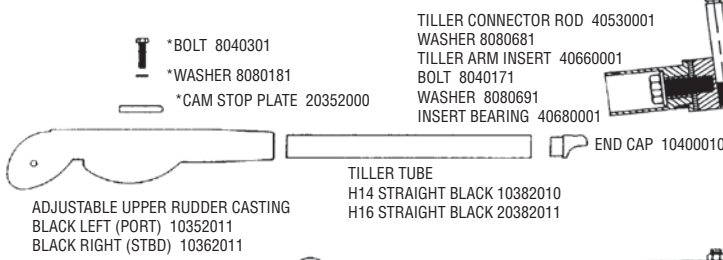

ADJUSTABLE LOWER RUDDER CASTING
BLACK 10412011

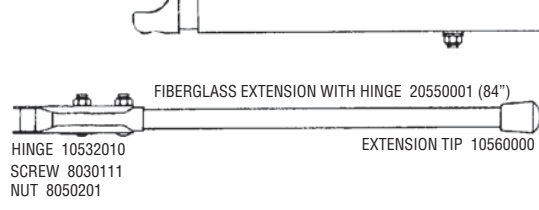
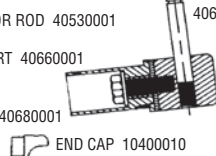
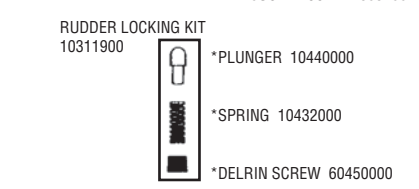
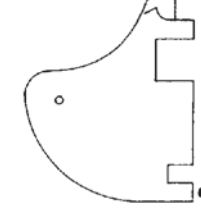

H14 / H16 TILLER CROSSBAR

H14 TILLER CROSSBAR BLACK 10520011
H16 TILLER CROSSBAR ORIGINAL BLACK 20520011

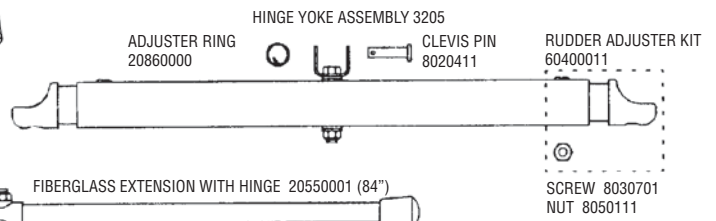

MIRACLE STYLE TILLER CROSSBAR

H16 TILLER CROSSBAR NEWER - MIRACLE 20521001
TILLER CONNECTER KIT 1953

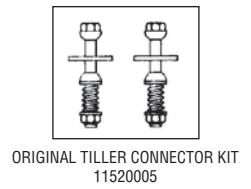
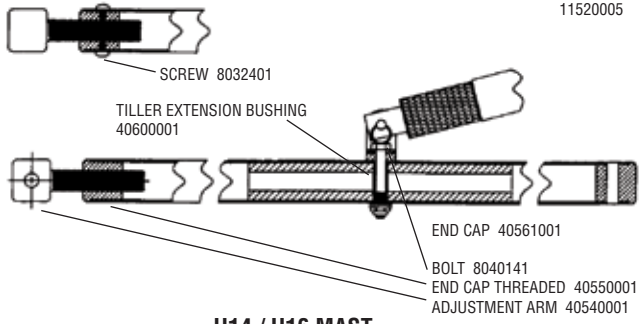

H14 / H16 MAST

H14 COMPLETE MAST ASSEMBLY BLACK 10581100
H14 COMPTIP ASSEMBLY 10582100
H16 COMPLETE MAST ASSEMBLY BLACK 20610000
H16 COMPTIP ASSEMBLY 20611100

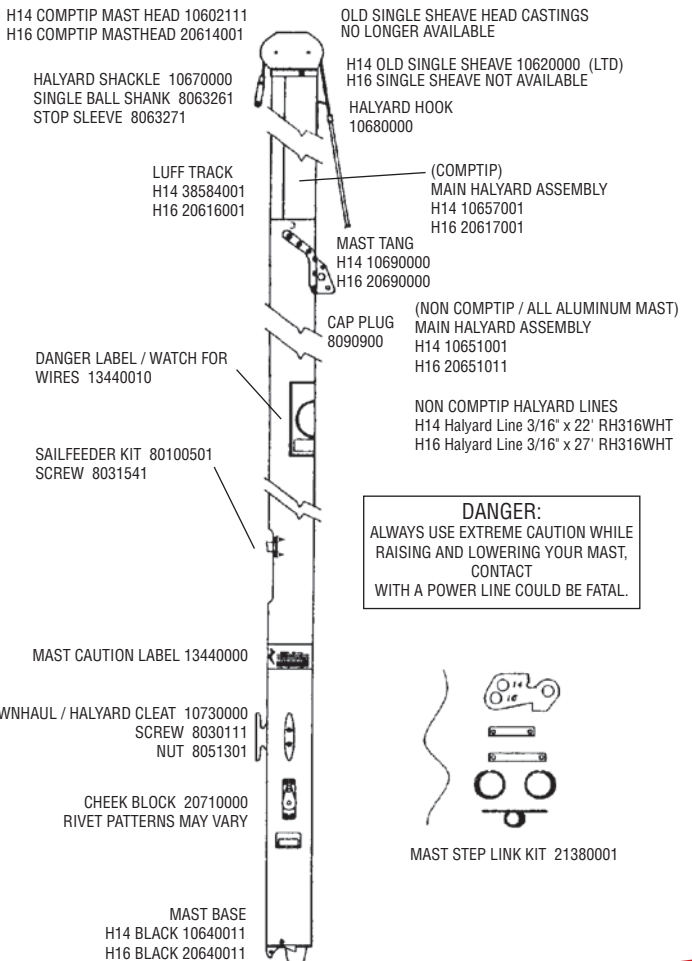

H14 Rivet Guide		H16 Rivet Guide	
() = Quantity needed to fasten part		() = Quantity needed to fasten part	
Mast		Mast	
Head	8010131 (2)	Head	8010131 (4)
Halyard Hook	8010181 (2)	Halyard Hook	8010181 (2)
	8011291 (2)		8011291 (2)
Tang	8010181 (6)	Tang	8010181 (12)
	8011291 (6)		8011291 (12)
Halyard Cleat	8010121 (2)	Halyard Cleat	8010121 (2)
Base	8010131 (3)	Base	8010131 (3)
Sidebar		Downhaul Cheek Block	8010181 (4)
Chain Plate	8010181 (3)	Front Crossbar	
Rear Crossbar		Corner Casting	8011231 (6)
Corner Casting	8011231 (6)	Mast Step	8011231 (4)
Traveler Track	8010201 (18)	Jib Track	8010201 (6)
or	8010161 (18)	Swivel Jam Cleat	8010201 (1)
Pad Eye	8010181 (2)	or	8010131 (1)
Swivel Jam Cleat	8010201 (1)		8031501 (2)
	8031501 (2)		8031231 (1)
	8031231 (1)		8050801 (1)
	8050801 (1)		8080101 (1)
	8080101 (1)	Rudder Assembly	
Boom		Upper Casting	8010131 (2)
Front End Cap	8010131 (3)	(underside)	8011231 (1)
Tang	8010181 (4)	Tiller End Cap	8010131 (2)
Barrel Cleat	8010181 (2)	Boom	
Block Hanger	8010181 (4)	Front End Cap	8010131 (3)
Rear End Cap	8010131 (3)	Tang	8010181 (4)
Front Crossbar		Barrel Cleat	8010181 (2)
Mast Step	8011231 (4)	Block Hanger	8010181 (4)
Corner Casting	8011231 (6)	Rear End Cap	8010131 (2)
Rudder Assembly		Rear Crossbar	
Upper Casting	8010131 (2)	Corner Casting	8011231 (6)
(Underside)	8011231 (1)	Traveler Track	8010201 (20)
Tiller End Cap	8010131 (2)	Pad Eye	8010181 (2)
Sail		Swivel Jam Cleat	8010201 (1)
Headboard	8010020 (16)		8031501 (2)
Tack/Clew plate	8010020 (6)		8031231 (1)
Pocket Protector	8010020 (4)		8050801 (1)
(Requires setting machine-not available as hand tool)			8080101 (1)
		Sail	
		Main Headboard	8010020 (16)
		Tack/Clew Plate	8010020 (6)
		Main Pocket Prtc	8010020 (4)
		Jib Clew Plate	8010020 (16)
		Jib Pocket Prtc	8010020 (3)

H14 / H16 FORESTAY ASSEMBLIES



H14 FORESTAY BLACK 10812101
H16 UPPER FORESTAY (PIG TAIL)
20810011

H16 JIB HALYARD AND LOWER FORESTAY

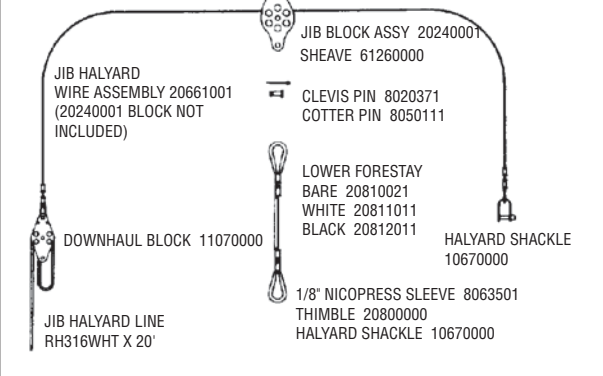

PIN AND RING SET 30303

CLEVIS PIN 8020381
RING DING 20860000

10 HOLE STAY ADJUSTER 20830020

H14 BRIDLE BLACK 10822101

H16 BRIDLE WHITE 20820011
H16 BRIDLE BLACK 20822011



SHACKLE 10700000



SHACKLES (FOR H14 WITH BOW PLATES) 10870000

H16 "AUSSIE" FORESTAY AND JIB HALYARD

80660000 Assembly

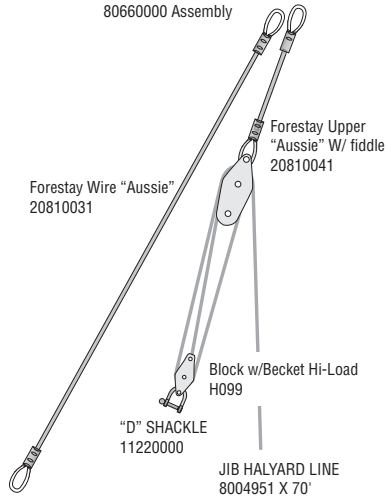

H14 / H16 SHROUDS



H14 SHACKLE 10700000
H16 SHACKLE 20700001



H14 SHROUD BLACK 10792100
H16 SHROUD WHITE 20790011
H16 SHROUD BLACK 20792011



1/8" NICOPRESS SLEEVE 8063501
THIMBLE 20800000



CLEVIS PIN 8020381
RING DING 20860000



7 HOLE STAY ADJUSTER 20830010



CLEVIS PIN 8020371
RING DING 20860000



TWIST TOGGLE 20210000



CLEVIS PIN 8020381
RING DING 20860000

H16 TRAPEZE



SHROUD SHACKLE 10700000
THIMBLE 20800000
3/32" NICOPRESS SLEEVE 8063761

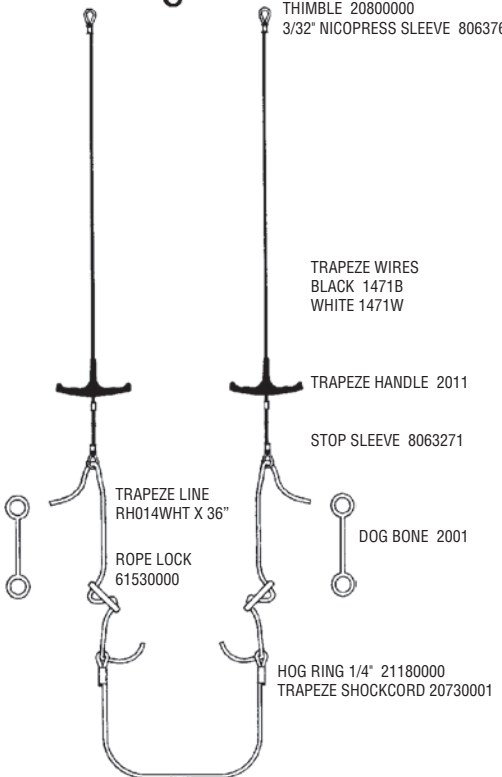

H14 TURBO RIGGING KIT

TURBO RIGGING KIT 80200000

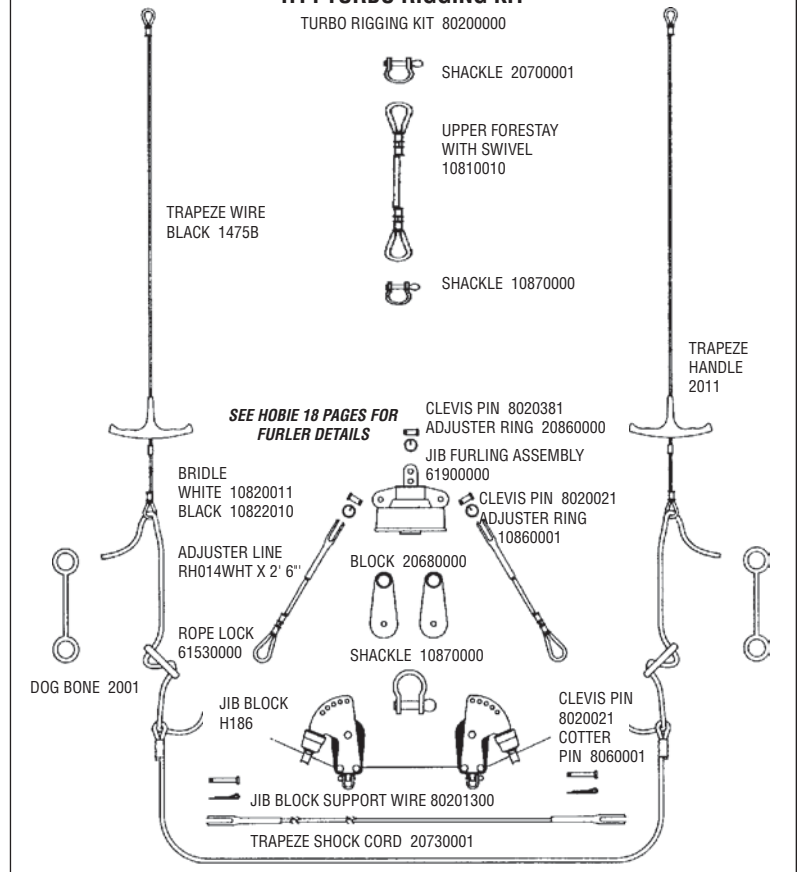

H14 / H16 MAIN SAIL & BATTENS

H14 MAIN SAIL 1099XXXX
 H16 MAIN SAIL 20991XXX
 SEE SEQUENTIAL PARTS LIST
 OR SAIL COLOR SELECTION SHEET

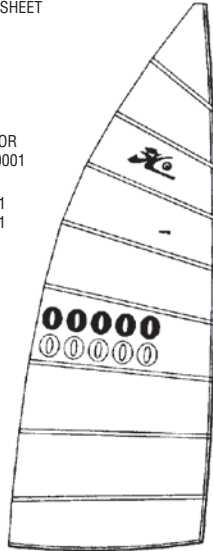
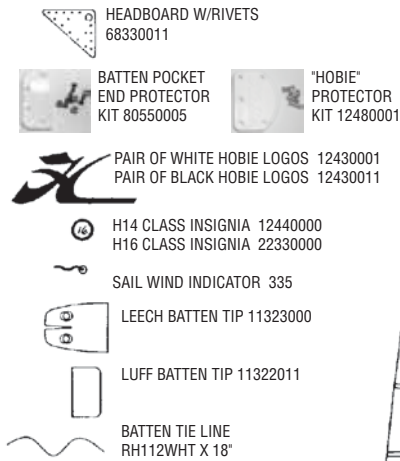

CLEW/TACK PLATE SET 12240000

SAIL BAG/COVER 21310000

SAIL NUMBERS

BLACK	
#0	12700030
#1	12710030
#2	12720030
#3	12730030
#4	12740030
#5	12750030
#6 & #9	12760030
#7	12770030
#8	12780030

MAINSAIL BATTEN LENGTHS

H16 BATTEN	H14 BATTEN
#8 41"	
#7 59 1/8"	
#6 72 1/8"	#6 42 11/16"
#5 82 3/8"	#5 60 7/16"
#4 90 3/4"	#4 74 1/16"
#3 97 3/8"	#3 84 13/16"
#2 103 7/8"	#2 93 5/16"
#1 107 7/8"	#1 97 7/16"

H16 MAIN BATTEN SET 21000001
 (FOR INDIVIDUAL BATTENS SEE UNIVERSAL BATTENS PAGE)

OUTHHAUL LINE RH316WHT X 7'4"

H14 / H16 JIB SAIL & BATTENS

H14 JIB 10992XXX SEE SEQUENTIAL PARTS LIST
 H16 JIB 20992XXX SEE SEQUENTIAL PARTS LIST

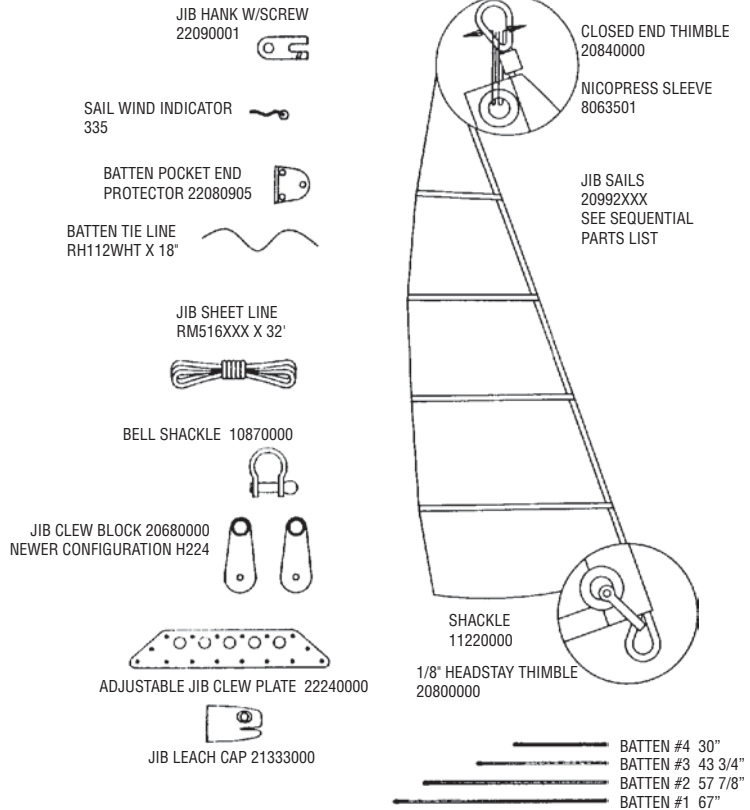

H16 JIB BATTEN SET 20400001
 FOR INDIVIDUAL BATTENS SEE
 UNIVERSAL BATTENS PAGE

H14 / H16 BOOM

H14 BOOM ASSEMBLY BLACK 10720011
 H16 BOOM ASSEMBLY BLACK 20720011

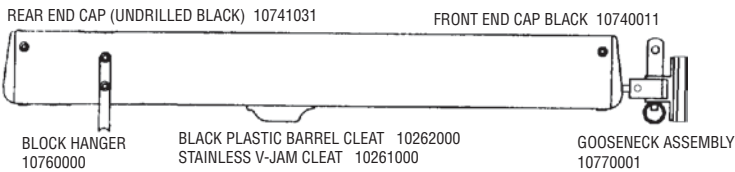

"E" CLIP 8062521
 FOR BOOM PIN
 THAT IS GROOVED.
 (OLD STYLE)

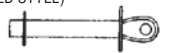

*BOOM PIN W/HOLE
 (W/ROLL PIN) 10772010

ROLL PIN 50502201
 FOR BOOM PIN
 THAT HAS A HOLE.
 (CURRENT STYLE)

NUT 8050121



BOLT 8040021



CLEVIS PIN 8020421
 NEWER - BOLT 8040001



ADJUSTER RING 10860001



CLEVIS PIN 8020061



SHACKLE 10772020



SLIDE 10772001



DOWNHAUL RING 10772070



COTTER PIN 8060101
 NEWER - NUT 8050101

DOWNHAUL LINE RH316WHT X 5'

H14 / H16 BLOCK SETS

