



**Hobie**

**SAILING PARTS & ACCESSORIES**

THROUGH **MARCH 2017**





# CONTENTS

ITEM	PAGE
LIFE VESTS / PFD	2-3
PET PFD / WET WEAR / SAFETY	4
TRAPEZE / GLOVES	5
TRAPEZE	6-7
WING SEATS / BACK RESTS	8
<hr/>	
SAILS	9-11
BATTENS	12-13
WIND INDICATORS	14
TRAMPOLINES	15
RIGHTING	16-17
<hr/>	
STEERING / RUDDERS	18
TILLERS	19
SAIL TRIMMING / HARDWARE	20-25
LINE	26
HATCHES / BAGS	27
<hr/>	
TRAILERS, STORAGE	28
TRAILER ACCESSORIES / MAST STEPPING	29
BEACH WHEELS / CARTS	30
COVERS / BAGS	30-31
STICKERS / TOOLS / REPAIRS / MAINTENANCE	32-33
MISC. ACCESSORIES / HOBIE BOOK	34-35
APPAREL / HATS / ACCESSORIES	36-39
<hr/>	
SUPPORT / WARRANTY	40
PART GUIDES	41-61
PART LIST	62-69

*Note: Freight to dealers is not included in pricing.*  
 No portion of this catalog may be reproduced without the express permission of the Hobie Cat Company.  
 All rights reserved. ©2016 Hobie Cat Company, Oceanside, CA 92056  
 Pricing subject to change. Printed in USA

# LIFE VESTS & PFDs



S6100xx (xx = size) MANGO

## HOBIE THIN-BACK by Stohlquist

Features a thin foam back design ... perfect for use with Hobie Vantage seats. This thinner back profile provides more mobility and comfort, while reducing interference with taller seat backs.

### FEATURES:

Thin back design works with all seat styles; Graded Sizing provides the best possible fit; Open sides for ventilation; Cross-chest cinch harness for zero ride-up; Mesh shoulders & interior panels for maximum ventilation; Adjustable shoulders, and dual forward pulls for a custom fit; Zippered front pockets offer organization; Built-in beverage holder and neoprene sunglasses sleeve; Entry grip tab at zipper base; #10 YKK zipper with non-corroding slider; Lightweight PE Foam; Type III PFD with sea level buoyancy: MD: 16 lbs, 8oz / LG: 17 lbs / XL: 17 lbs, 8oz

### CONSTRUCTION:

- Mini Ripstop nylon outer shell
- 200 denier oxford liner
- USCG approved

### SIZING:

MEN'S		WOMEN'S	
SIZE	CHEST	SIZE	CHEST
MD	30" - 40"	SM	28" - 34"
LG	40" - 46"	MD	34" - 40"
XL	46" - 52"	LG	40" - 46"



S6101xx (xx = size) RED



S6102xx (xx = size) GREEN



S6114xx (xx = size) WOMEN'S BLUE



S6110xx (xx = size) WOMEN'S MANGO

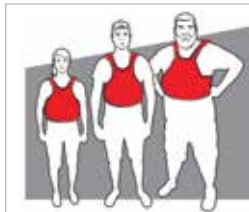

### GRADED PFD SIZING

Fine tuned for each individual size, and sculpted foam footprint and foam thickness to provide a better fitting, and more comfortable PFD for people of all sizes.



### HOBIE MIRAGE PFD

This PFD was designed for Vantage high back seats on Hobie Mirage Kayaks. The flotation in the back is thin for more comfort while seated and helps to prevent the vest from riding up as you pedal. A vent along the spine adds to the comfort. Front zip entry for easy on and off. Large pockets on the front for easy storage and access of small items. High waistline cut so the vest does not ride-up while pedaling. Huge arm cutouts and the short waist allow excellent freedom of movement. Adjustable side straps offer enough size variation for many layers underneath or none! Reflective tapes for visibility during low light conditions. Back logos vary between "H" and Penguin Logo.

(xxx = SMD - MLG - LXL) (UL - Approved) for use in USA Only

**S6800xxx** PFD MIRAGE GRAY

#### SIZING

SIZE	CHEST
SMD	33" - 39"
LXL	40" - 46"
XXL	48" - 54"



### HOBIE EDGE by Stohlquist

An innovative, high mobility, low profile boating vest for kayaking, SUP, and wetsailing.

**S6120xxx** (xxx = size)

#### FEATURES:

Ergonomic WRAPTURE™ shaped torso; Adjustable shoulders, 4 side pulls, and front waist buckle closure; Low cut, offset front-zip entry; Large arm openings for unrestricted whitewater and SUP paddling; Contoured padded shoulder straps; High visibility 3M™ reflective accents; Roomy, top loading front pocket for secure storage and easy accessibility; Mesh sides for maximum ventilation; Mini-Ripstop nylon shell & 200 denier oxford liner; Type III PFD with sea level buoyancy listed: SMD: 15 lbs, 8oz / LXL: 16 lbs, 8oz / XXL: 17 lbs, 8oz

#### CONSTRUCTION:

- Mini Ripstop nylon outer shell
- 200 denier oxford liner
- USCG approved

### ! SAFETY TIP

**LIFE VESTS:** Get a good, comfortable life vest and WEAR IT! A life vest does you little good stored on your boat, especially if you get tossed into the water and away from your boat. Accidents happen and by their nature, they happen when you are not prepared. A life vest can keep you afloat until you can rescue yourself or you can be rescued by others. In the worst cases when injuries or cold water are involved, your life vest can make all the difference! Be sure everyone onboard your boat wears a life vest too! Pass the word! Federal law now requires that all persons below the age of 13 must wear a life jacket while aboard a boat.



### HOBIE INFLATABLE PFD

Light weight and comfortable. Ready when you need it, manual CO2 inflation or buy mouth inflator allows for swimming, wading and intentional immersion. Available in Mango, Tan/Gray or Red/Gray.

**S6779MG** MANGO

**S6779TG** TAN / GRAY

**S6779RG** RED / GRAY

**S6779R** PFD INFLATABLE REARM KIT

**NOTE:** AIR SHIPPING RESTRICTIONS CO2 / DANGEROUS GOODS

#### FEATURES:

Buoyancy: 26 Pounds; Inflator Type: Halkey Roberts 3F; Primary Inflation: MANUAL; Auxiliary Inflation: Oral; Size and U.S.C.G. Wearer Requirements: Adult Universal: For persons 16 years or older, weighing more than 80 lbs., with chest size of 30 - 52 inches; U.S.C.G. Approval Type: U.S.C.G. Type III; Durable Ripstop Nylon Front Shell; Waist Belt Width: 1"; Zippered External Pocket; Reflective Strips; Sunglass Hanging Loop



### HOBIE INFLATABLE BELT PACK PFD

Belt carried PFD design is cooler and more comfortable than typical PFDs. Functional design for multiple types of water sports from fishing, kayaking, sailing to stand up paddling (SUP). Buoyancy: 26 Pounds. USCG Approved Type III PFD, approved for use by persons 80 lbs and 16 years of age or older. Size: Universal Adult Size. Durable ripstop nylon pack. 2" wide, adjustable, nylon waist belt. Includes (1) CO2 Cylinder and instructions.

**S6780RG** RED/GRAY

### HOBIE INFANT/CHILD/YOUTH VESTS

These are easy to adjust for different small sized crews. (Mango)

**S6770IMG** <30 lbs

**S6770CMG** 30 to 50 lbs

**S6770YMG** 50 to 90 lbs



### HOBIE SPRAY TOP

Designed for active kayaking and sailing. Can be worn with swim trunks or over a wetsuit. Mix and match layers to get the comfort you desire. Spray and wind protection. Beautiful styling and extra durable construction. Construction Features: Neck and wrist seals, Neoprene waist seal, Breathable 5000cm3 nylon shell, Offset chest pocket, Arm patch pocket. Colors may vary.

#### HOBIE SPRAY TOP

3850SM / 3850MD / 3850LG / 3850XL



### HOBIE PET PFDS

You can now take your best friend with you safely and in Hobie Style! Added flotation as a swim assist and grab handles, so you can help them back aboard more easily. Adjustable fit, leash attachment, side pockets, grab handles and soft foam undercarriage support. Happy days for dogs!

#### FEATURES:

Tri segmented soft foam design; Foam supported Ripstop-nylon collar; Dual cargo pockets (S, M, L, XL); Dual integrated grab handle design (M, L, XL); Soft foam undercarriage support chasis; Integrated leash attachment

- S9000XS** PET PFD XS MANGO <12#
- S9000SM** PET PFD SM MANGO 12-24#
- S9000MD** PET PFD MD MANGO 24-60#
- S9000LG** PET PFD LG MANGO 60-90#
- S9000XL** PET PFD XL MANGO >90#

#### SIZING:

SIZE	WEIGHT	COLLAR	BODY GIRTH
XS	12 lbs.	8" - 12"	13" - 17"
S	12 - 24 lbs.	10" - 14"	15" - 21"
M	24 - 60 lbs.	13" - 19"	18" - 30"
L	60 - 90 lbs.	18" - 26"	24" - 36"
XL	90 - 120 lbs.	22" - 30"	30" - 42"

### HOBIE FIRST AID KIT

Waterproof 3600 Plano box with essential first aid items.

72020078 HOBIE FIRST AID KIT



### SAFETY WHISTLE

A whistle can save your life! Keep one attached to your PFD in case of over-board emergency. Alert approaching vessels. Alert other boaters or people ashore that you need help.

MK0053 SAFETY WHISTLE

### HYDROSTAR - SOS DELUXE

Everything you need for lighting in one compact waterproof package.

72020003 HYDRO STAR SOS LIGHT



#### HYDRO STAR

##### FEATURES:

- 5 light settings
- Magnetic base
- Suction cup base
- Lanyard clip
- Integrated safety whistle
- Submersible to 50ft

##### SPECS / FUNCTION:

- Dimensions: 6in H x 1.25in DIA
- 1 CLICK : 3 LED Light (10LM)
- 2 CLICKS : 3 LED Strobe (15LM)
- 3 CLICKS : 360° Deck Light (Red:6LM/Green 2LM)
- 4 CLICKS : Emergency 1 Watt LED Strobe (65LM)
- 5 SECOND HOLD : SOS Signal (65LM)



### ANCHOR KIT

Folding 3 lb anchor, bag and 60 feet of line.

80035A ANCHOR



### TELESCOPING PADDLE

Measures just 20" in closed position (45" when fully extended). Lightweight, anodized aluminum shaft corrosion resistant design. Floats tool 6 1/2" wide blade will fit into an 8" hatch opening.

3091 TELESCOPING PADDLE



13826 Bar Only

**FULL "AUTO" HARNESS**

For those looking for added back support and comfort while on the trapeze. Great for spending lots of time on the wire. New spreader ratcheting feature allows easy adjustment of harness around hips as well as quick release feature to get out of harness quickly. Crotchless design with neoprene leg straps, adjustable lumbar support, neoprene covers over side buckles, and reinforced patch on the seat. Comes with 10" stainless spreader bar that can only be used with this harness. Colors may vary.

**1376xx** Full "Auto" Harness  
(xx = size) (SM,MD,LG,XL)



**CONVERTIBLE HARNESS**

"Converts" easily from a half harness to full harness with the addition of shoulder straps (included). The all around harness for both racers and recreational sailors where comfort, support and mobility are key. For the recreational sailor the half harness has enough back support to keep you comfortable on the tramp or the trap. For the racer, just add the shoulder straps for those long days out on the trapeze where extra back support is needed. Extra stiff back support, padded leg straps/shoulder straps, neoprene covers over buckles and a 10" stainless spreader bar. It all adds up to keeping you comfortable and having fun on the water. Shoulder straps included with harness. Colors may vary.

**1378xx** CONVERTIBLE HARNESS  
(xx = size) SM [Small/Medium], LG, XL)

**SKIPPERS HARNESS**

The harness for both racers and recreational sailors where comfort and mobility on the trampoline are most important. For the sailor who spends less time on the trapeze or prefers to "sit up" rather than lean out more. Unique leg strap design combining neoprene and webbing to eliminate chafe. Neoprene covers over side buckles and a 10" stainless spreader bar. Reinforced seat. Colors may vary.

**1388xx** SKIPPERS HARNESS  
(xx = size) (SM, MD, LG, XL)



**RONSTAN GLOVES**

Double thickness palm and fingers for protection and grip. Mesh panels for flexibility, comfort and quick drying. Low cut neoprene wrist band. Sticky gloves reduce fatigue by minimizing the physical effort required to hold ropes.  
(xx = size XS/SM/MD/LG/XL)



**RF4851xx** Three Finger Glove



**RF4850xx** Short Finger Glove



**HOBIE GLOVES**

Protect your hands while increasing your grip strength. Gloves add grip strength on lines which can ease up on the amount of force you need to exert. Available in small, medium, large & extra-large. (xx = size)  
**3188xx** HOBIE GLOVE

**TECH TIP!**

**SAILING GLOVES:** Get a good grip on your lines. Sailing gloves absorb and distribute the sheet rope load, as well as protect your skin from wear and tear. Lower cost gloves are fine for the casual sailor. The more rigorous the sailing conditions the more a higher quality glove is required. Our high end gloves are double thickness leather in high wear areas, padded to spread out the squeeze load on your hand and reasonably easy to get on and off.



**COATED TRAP WIRE SETS**

Highest quality aircraft stainless wire coated with UV tolerant black or white vinyl coating for all of our wire products. Molded nylon handles are installed at the right place for easy in and out maneuvering. Also available in kits which include the trapeze shock cord.

- 1471W H16,17,SPORT PAIR-WHITE
- 1472W ABOVE w/ SHOCKCORD (16 only)
- 1471B H16,17,SPORT PAIR-BLACK
- 1472B ABOVE w/ SHOCKCORD (16 only)
- 1473W H18 PR (1 SIDE)-WHITE
- 1474W ABOVE w/ SHOCKCORDS
- 1473B H18 PAIR (1 SIDE)-BLACK
- 1474B ABOVE w/ SHOCKCORDS
- 1475B H14 PAIR-BLACK
- 1476B ABOVE w/ SHOCKCORD
- 1478B GETAWAY PAIR-BLACK



**WAVE / GETAWAY TRAPEZE KITS**

Add a trapeze system to your Hobie Wave or Getaway. Complete with wires (pr), return bungee system, lines, blocks, locks and dog bones. Just add a trapeze harness and you are flying! Wave kit includes adjustment lins with internal shockcords and hull attachment hardware.

- 38140001 WAVE TRAPEZE KIT
- 37140001 GETAWAY TRAPEZE KIT

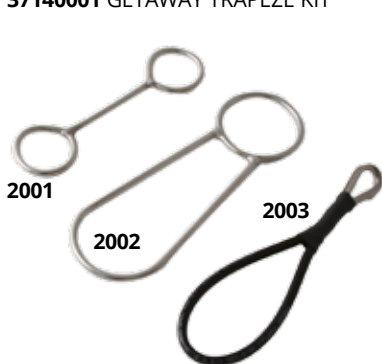

**TRAPEZE DOGBONES**

These dogbones feature high grade 316 stainless steel with welded construction for superior strength.

- 2001 STANDARD
- 2002 KEYHOLE SHAPE
- 2003 FLEXIBLE DOGBONE



**HARKEN MICRO FIDDLE BLOCK**

Superior quality Micro Fiddle Block with V-Jam cleat from Harken. For use with 7/32" to 5/16" (5mm-8mm) line to make adjustable trapeze system. H244 Each

**DOUBLE ADJUSTABLE TRAPEZE**

Adjust the level of the entire system, ring and handle. Always have the trapeze "T" handle at the proper comfortable to reach level. Crew can move fore and aft to extremes and maintain efficient and comfortable trapezing level. Bungee gives constant upwards pull on trapeze ring to ensure that you stay hooked up. Stock trapeze wire must be shortened by approx. 8". Order trapeze rings and bungee separately.

1204 Kit



**J & H HANDLES**

Open design combination dogbone/trapeze handle makes getting hooked and unhooked very simple. Choose a different color for the skipper and crew for easy identification.

- 2004BLK PAIR-BLACK
- 2004WHT PAIR-WHITE



**A. DELUXE ADJUSTABLE TRAPEZE RIG**

The original trap rig. Adjust your position while you are out on the wire. V-Jam pulley system allows you to compensate for that puff or lull in the wind without coming in off the wire. Comes complete with all blocks, ropes, and swivels needed for one pair.

1203 w/o DOGBONES

**B. STANDARD ADJUSTABLE TRAPEZE RIG**

The standard kit includes blocks with removable sheaves, rope, rope locks and stop washers. Can be purchased with #2002 dogbones or without dogbones (for possible use with J&H Handles.)

- 3101 w/ DOGBONES
- 3102 w/o DOGBONES



**MOLDED TRAPEZE HANDLE**

Strong and comfortable molded grips are contoured to fit the hand. Wire guide shank keeps wire from cutting between the fingers. This is the "standard" handle on all wires.

2011 Each

**REPLACEABLE TRAPEZE HANDLE**

This simple, rubber padded, all aluminum handle can be installed on any 3/32" wire without disconnecting anything. Just screw the 2 halves together and it's ready to use.

2010 Each

### RAIL RUG

Provides excellent footing when out on the trapeze. Kit includes a high quality grade of carpeting which absorbs less water, keeping weight down and reducing mildew. Also included in each kit; industrial grade contact cement (much better than the hardware store variety), brush and easy to follow instructions. For all catamarans.

- 1671BLK H14/16-BLACK
- 16703 CONTACT CEMENT-PT



### REMOVABLE SHEAVE TRAP RIG BLOCK

This is the block we include in our basic trap rig kits. No need to cut wires to install this block. Simply remove the clevis pin that acts as the sheave axle, slide the sheave out of the frame, place the frame through the trap wire thimble and reinstall the sheave.

3103 Each



### NEOPRENE RAIL KITS

Provides excellent footing while out on the trapeze and cushions the non-skid areas. Eliminates abrasion on your skin or clothing because it sheds sand. Zero water retention. Made out of 1/8" thick knobby black neoprene. Kit includes industrial grade contact cement, brush, and instructions for easy installation on any boat. Race strips are for hull decks rear of trampoline frame. H16 kits are full wrap around as used in Worlds boats.

- 16706 H14 / H16 KIT
- 16707 RACE STRIPS-PAIR
- 16708 H18 KIT
- (H18 Die Cut - Shown Above)



### TRAP STAY

An easy answer to wandering wires and "who's whose" confusion on the Hobie 16. Mount these little keepers under the side rails and drop the shockcord in. Works great to keep everything in its place.

176 Pair



### ROPE LOCK

Use on trapeze rope to make your trapeze system adjustable.

61530000 Each

### TECH TIP!

**Trapezing:** While sitting on the edge of the boat, attach the trapeze dogbone to the trapeze hook on your harness. Grab onto the trapeze wire's handle with your forward hand. Place your other hand on the hull behind you. Using your hands for balance ease yourself off the side of the boat and place your forward foot on the rail. Push yourself away from the boat with your rear hand and forward foot till you can place the rear foot on the rail. Stand on the rail of the boat with your weight on the trapeze wire. Keep your forward leg more ridged and aft leg slightly bent. This position will help keep you from falling forward.

While learning to trapeze, beginners should set their trapeze height just at the rail level or slightly above. This will make it easier to get in and out. Keep your legs spread several feet apart for balance. As you get used to the feel of trapezing you can begin to lower your trapeze height and move your legs closer together. Once you become an expert on the trap wire, your proper body position should be parallel to the deck with your feet right next to each other.

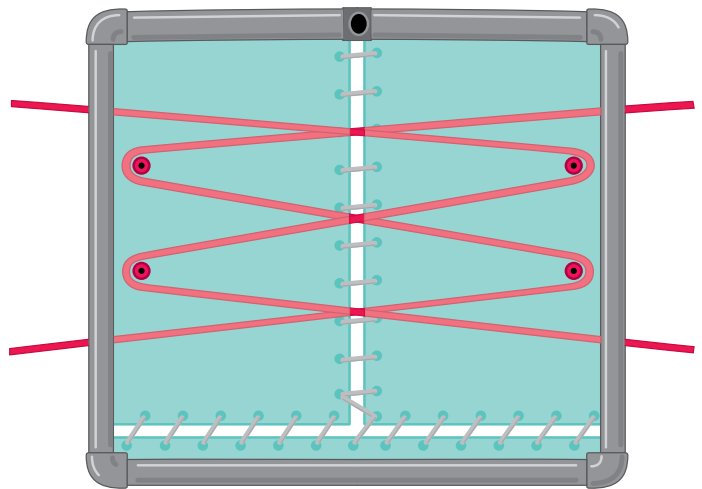

### TRAPEZE RIG RETURN SYSTEM

Custom system with double-length shockcord reduces the unpleasant forward pull when you're trapped out off the stern on a reach. It also prevents breakage of the shockcord when you stuff a lee bow and the crew takes a spin around the forestay. All required hardware is included.

14709 H16 KIT

# PERFORMANCE COMFORT

## GETAWAY WING SEATS

These are perfect for lazy day sailing, relaxed hiking out on your Hobie Getaway or for high performance fun. Turquoise vinyl mesh covers aluminum extrusions that are contoured to make a very comfortable back rest or seat. Remove two quick pins per side and they rotate in for trailering.

**37001000** WING ASSEMBLY WITH TURQ SEAT COVER

**37001010** WING ASSEMBLY WITH GREY SEAT COVER 2017+

**37971058** REPLACEMENT COVER - TURQ MESH

**37977058** REPLACEMENT COVER - GREY MESH



HOBIE WAVE

## WAVE BACK RESTS

These simple to install Back Rests are perfect for lazy day sailing on your Hobie Wave. The last word in sailing comfort. They plug into the front and rear cross beams. On or off in 3 minutes or less.

**38040011** BACK REST, SET (BLUE)

**38040012** BACK REST, SET (GREY)

**38041001** REPLACEMENT PAD COVER (BLUE)

**38041002** REPLACEMENT PAD COVER (GREY)

**8020181** FAST PIN (EACH) FOR QUICK RELEASE OF BACK RESTS. FOUR REQUIRED. SOLD SEPARATELY.

### NOTE: ADDITIONAL FREIGHT CHARGE ITEMS

Items shown on this page will incur additional freight charges from the factory that are not included in pricing shown.



## BRAVO / WAVE / GETAWAY

## 14 / 16 / 18



Bravo Seabreeze

Getaway Seabreeze Main With Turquoise Jib

Wave Seabreeze

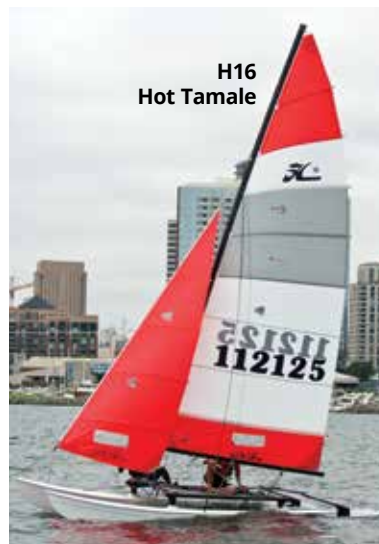

H16 Hot Tamale



H16 Seabreeze

### BRAVO

90990021 SAIL, BRAVO MAIN SEABREEZE

### WAVE

- 38991000 SAIL, WAVE MAIN WHITE
- 38991050 SAIL, WAVE MAIN "H" RESORT WHITE
- 38991088 SAIL, WAVE MAIN "H" RESORT SEABRZ
- 38991077 SAIL, WAVE MAIN SEABREEZE
- 38991078 SAIL, WAVE MAIN SEABREEZE W/ZIP
- 38992010 SAIL, WAVE JIB WHITE
- 38992071 SAIL, WAVE JIB TURQ
- 38992007 SAIL, WAVE JIB YELLOW

### GETAWAY

- 37991076 SAIL, GETAWAY MAIN SEABREEZE
- 37992071 SAIL, GETAWAY JIB TURQ

### HOBIE 14

- 10990010 SAIL, H14 MAIN, WHITE
- 10991086 SAIL, H14 MAIN, CORONADO
- 10992511 SAIL, H14 JIB, WHITE
- 10992081 SAIL, H14 JIB, TURQUOISE

### HOBIE 16

- 20991011 SAIL, H16 MAIN, WHITE
  - 20991087 SAIL, H16 MAIN, HOT TAMALE
  - 20991088 SAIL, H16 MAIN, SEABREEZE
  - 20992010 SAIL, H16 JIB, WHITE
  - 20992071 SAIL, H16 JIB, TURQ
  - 20992081 SAIL, H16 JIB, SILVER
  - 20992086 SAIL, H16 JIB, RED
  - 20992088 SAIL, H16 JIB, SEABREEZE
  - 20992310 SAIL, H16 JIB, WHITE (VELCRO\*)
  - 20992386 SAIL, H16 JIB, RED (VELCRO\*)
  - 20992388 SAIL, H16 JIB, SEABR (VELCRO\*)
- VELCRO\* = Velcro closure / tensioned battens (less halyard hangup)

### HOBIE 18

- 60991011 SAIL, H18 MAIN, WHITE
- 60991086 SAIL, H18 MAIN, CORONADO
- 60992011 SAIL, H18 JIB, WHITE
- 60992071 SAIL, H18 JIB, TURQUOISE

**SEE PARTS LIST FOR ALL OTHERS**



### HOBIE WAVE JIB KIT

Bring your Wave sailing up a level. More sail area (jib adds 25 sq ft) equals more speed and performance in light wind conditions. The Wave jib accelerates learning and encourages participation of your crew in sailing. Our jib hardware kit comes complete with bow spreader pole, all the nuts, bolts, and blocks required. Order jib separately.

- 38999001** WAVE JIB HARDWARE KIT
- 38992010** WAVE JIB, WHITE
- 38992071** WAVE JIB, TURQUOISE
- 38992007** WAVE JIB, YELLOW

### JIB KIT SPARE PARTS

- 38999021** BOW SPREADER POLE ONLY
- 38120041** TANG FOR BOW SPREADER POLE



### HOBIE 14 TURBO KIT (JIB & FURLER)

Add Turbo power and enjoy the excitement of trapezing from the 14 with the complete Turbo kit (comes complete with trapeze and jib sheeting hardware). A dolphin striker is required for trapezing. If your boat is pre-1982, order the upgrade kit for new length shrouds, chain plates and tramp jib grommets. Order jib separately.

- 80200000** TURBO KIT w/ HOBIE FURLER
- 80200020** TURBO UPGRADE KIT (pre-'82)
- 80200010** DOLPHIN STRIKER KIT (pre-'82)

- 10992511** WHITE JIB
- 10992081** TURQUOISE JIB

## TECH TIP!

**ROLLER FURLING JIBS:** Just roll the jib up when you come into the beach or de-power if it gets too windy. Want to fly a spinnaker? The furling systems work great for easy spinnaker flying. A roller furling jib system can increase the life of your jib by avoiding flogging the jib material while on the beach or between races. Allows you to store the boat without lowering the jib (jib "snorkle" cover suggested). Kits available for the Hobie 20, 17, 16, 14.

### HOBIE JIB FURLER SYSTEMS

Just roll the jib up when you come into the beach or de-power if it gets too windy. Speed, excitement and convenience all rolled into one!

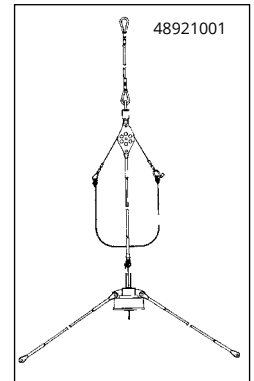

### HOBIE 16 FURLER KIT

Order a new furling jib separately or requires a re-cut of the standard jib.

- 8001** KIT w/ HOBIE FURLER
- 8002** WHITE FURLING JIB

### HOBIE 16 FURLING GENNAKER SYSTEM

Increase your off-the-wind sailing performance with this pole-mounted furling genaker. A large reaching genoa attached to a furling drum mounted on a pole which moves the sail area further forward like a spinnaker, but furling for easy deployment and retrieval.

- 20999201** POLE, FURLER, HARDWARE AND WHITE GENNAKER

### HOBIE 20 FURLER

Complete jib furling kit. Uses standard H20 Jib. No jib modification needed. Includes patented Hobie furler drum, forestay, halyard system and all needed hardware and fasteners.

- 48921001** H20 JIB FURLING KIT



### 17 SPORT "BOOMLET" SAIL FOOT

When the boom is removed, it is much easier for your passengers and crew to travel from one side of the boat to the other while tacking or jibing. 1995 and newer Hobie 17 "SE" sails can easily be converted to a "Boomless Sport" by adding the "Boomlet".

- 52722011** '95 AND NEWER SPORT "BOOMLET"

# SPINNAKERS

## SPINNAKER SYSTEMS

Quick setup, ease of use, and maximum performance were just a few of the design criteria. Our spinnaker kits provide better sail control with fewer lines. The Spinnaker Pole and Rig Kit contain all the equipment and lines to control hoisting, setting the tack and sheeting the Spinnaker. Just pull on the halyard...the sail is hoisted and the tack is hauled out to the pole end!

### HOBIE 16 / GETAWAY\* TRUMPET SNUFFER SPINNAKER SYSTEM (\*GETAWAY USE REQUIRES SOME KIT MODIFICATIONS. INSTRUCTIONS ONLINE)

20999020 POLE, SNUFFER, SPINNAKER & HARDWARE  
F16032110 SPINNAKER REPLACEMENT (COLORS VARY)

### HOBIE WAVE

38999000 WAVE POLE & HARDWARE KIT ONLY  
38999052 WAVE SPINNAKER (COLORS VARY)



HOBIE GETAWAY



HOBIE 16 / SNUFFER SYSTEM

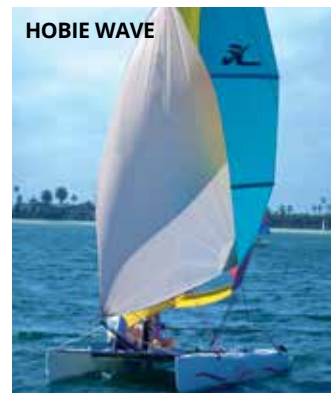

HOBIE WAVE

## TECH TIP!

**SPINNAKERS:** Flying a spinnaker is one of the great thrills of sailing. And one of the great challenges for both skipper and crew. Spinnakers increase downwind speed while actually creating lift at the bows! Few things compare to the thrill of running off the wind under a huge and colorful spinnaker! Spinnakers require special rigging. A survey of the products on these pages will give you a good idea of the options available.

## UNIVERSAL BATTENS

Availability of the correct batten has often been a problem. The various models of Hobie Cats all use different batten and taper lengths. In earlier years, each model Hobie used a different color batten. The battens were all the same specification, just a different color. We now stock only white sail battens for all models.

Complete battens sets, cut and tapered to specification length are available for some models. Individual battens are filled from stock as shown in the following table. Batten numbers start from the bottom batten in each sail (#1). Battens are trimmed by purchaser to exact length. Stock batten lengths are shown in the illustrated Hobie parts pages. (T)=Tapered

**82010001** BATTEN (max 107 7/8", min 87 5/16") *not tapered*

**82020001** BATTEN (max 82 3/8", min 72 1/8") *not tapered*

**82030001** BATTEN (max 90 1/8", min 46 1/8") 27" *taper*

**82040001** BATTEN (max 42 11/16", min 39 1/16") 27" *taper*

**82060001** BATTEN (max 100 9/16", min 67 7/8") 27" *taper*

**82070001** BATTEN (max 67", min 51 3/4") *not tapered*

**82080001** BATTEN (max 43 3/4", min 24 1/8") *not tapered*

	82010001	82020001	82030001	82040001	82060001	82070001	82080001
	107 7/8"	82 3/8"	90 1/8"(T)	42 11/16"(T)	100 9/16"(T)	67" (J)	43 3/4" (J)
<b>WAVE</b>		1,2,3				4	5
<b>H14</b>	1,2		3,4,5	6			
<b>GETAWAY</b>	1,2		3,4,5,6,7				8
<b>H16M</b>	1,2,3,4	5,6	7	8			
<b>H16j</b>						1,2	3,4
<b>H17</b>			3,4		1,2	5	6
<b>H18</b>	1,2,3,4,5		6,7,8	9			10
<b>H18SX</b>	1,2,3		8		4,5,6,7		9
<b>H21SE</b>	1,2,3		4,5,6				7



### TECH TIP!

**SAIL CARE:** At the end of the day most cat sailors roll their sails on the lower batten or around the boom. If you do, roll your sail loosely. Any sharp bends in the sail cloth break down the resin coating on the cloth. This weakens the cloth leading to premature stretching or pin size holes that will grow. You can lengthen the life of your sails with careful handling and by using some of the special accessories we offer. The various tapes and sleeves we offer are all intended to protect the sail from sharp edges and abrasive areas on the boat that wear away at the sail's fabric until suddenly there's a hole and next a tear. It's never too late to slow down wear and tear.



### SUPER JIB BATTENS

Work your jib with greater ease. Light and limber fiberglass battens virtually eliminate hangups when tacking the Hobie 16 and give your jib superior shape in light air when you need it most. Increases drive compared to the stock jib battens. Not class legal for racing but so nice to use the rest of the time. Complete with end caps.

**122** SET OF FOUR

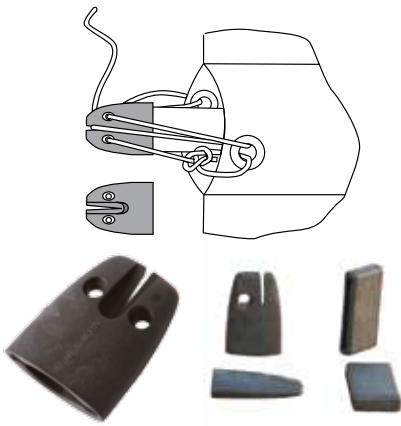

## HOBIE CAT LEACH & LUFF CAPS

Release the batten tension whenever you store your sails. This will prolong the life of your sails. Luff caps and adjustable leach caps are made of high strength, ultra-violet tolerant Delrin®. No knots to tie or untie. Tension adjustment lines not included. Sold individually. 4:1 mechanical advantage allows finer adjustment than does Trentec 2:1 caps.

**11323000** MAIN LEACH  
**21333000** JIB LEACH  
**11322011** MAIN LUFF TIP

## BATTEN CAP SETS

**1521H** HOBIE 14/17 SET  
**1522H** HOBIE 16 MAIN SET  
**1531H** HOBIE 16 JIB SET  
**1523H** HOBIE 18 SET

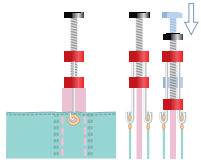

## BATTEN TENSIONER

Talk about precision batten adjustment. This screw thread adjuster allows as fine an adjustment as you want. It clips to the sail (at the batten tie string grommets) and pushes against the end of the batten. No batten cap is required. Use with Trentec Draft Gauges and always know exactly what your sail shape (due to batten tension) will be.

**1528** EACH



## TRENTEC DRAFT GAUGES

Use these coded, adhesive backed vinyl strips to calibrate your batten tension for each and every wind condition. Scale calibration mathematically calculated for each batten to assure consistent batten tension.

**1541** H14 KIT  
**1543** H18 KIT



## TRENTEC LUFF CAPS

Prevent "poke through"! These Trentec caps slip over the luff (front) end of your mainsail battens to increase the life of your sails and of the batten-pocket protectors. Each cap is molded at the angle to match the angle at which the batten meets the luff.

**1561** H14 KIT (6)  
**1562** H16 MAIN KIT  
**1563** H18 KIT  
**1566** H16 JIB KIT



## SPREADER BAR END COVERS

Smooth and resilient vinyl spreader bar end covers protect the jib luff from wear and tear on cotter keys and sharp edges. A real sail-saver.

**3262** PAIR



## JIB PROTECTOR KIT

Install hard plastic covers specially designed for cotter keys and Hobie 18 and 20 spreader bar ends. No slitting or taping required.

**1512** H18 Kit  
**1513** H20 Kit



## SAIL CHAFE PROTECTOR SET

From Harken. A split roller predrilled to fit up to 3/16" diameter wire. Replaces diamond wire rollers.

**H285** SET



## BATTEN POCKET ANTI- CHAFE TAPE

Your sail is expensive! Save it from an early grave with space age tape that affords ultimate protection to the batten pockets—where the shrouds eat through the cloth. Even covered shrouds don't postpone this for long! This remarkable material has up to 10 times the abrasion resistance of steel and yet this transparent tape will not hide your sail's colors or leave you with a gummy, unsightly residue that Duct tape and other tapes will. **Great for use on all full-battened sails!**

**1491** H16/20 MAIN  
**1492** H14/17 MAIN  
**1493** H18 MAIN 3  
**1494** TAPE PER FOOT



## SAIL REPAIR TAPE

Don't get caught with your sails down! Extra strong, Rip Stop white tape for temporary on-the-spot repairs to torn sails, canvas, even foul weather gear. Keep a roll in your toolbox for emergencies.

**1662** 2" x 25' ROLL



## SAIL REPAIR KIT

Takes care of emergency repairs to sails and trampolines. Kit includes 3 different weights of thread, 3 sizes of needles, and 6" x 6" white sail cloth.

**1665** KIT



**TECH TIP!**

**WIND INDICATORS:** When sailing downwind, without a bridle fly, you can't gauge apparent wind direction without looking up and taking your attention off the action (boats crossing) on the water. The light weight indicators are most suitable in moderate and stronger wind conditions. Not severely affected by wave action, they work well tacking downwind. They are both durable and sensitive. The heavier Telo Cat is the most durable. It stands up to crashing waves sailing in rough conditions. A bridle fly is very effective when sailing off the wind, especially in light and moderate air, but will also give you indication of wind shifts on any point of sail.

CM7703

**HOBIE BRIDLE FLIES**

Durable Mylar wind vane with excellent light to moderate air response. Adjust your sails to the apparent wind angle. A must for best downwind sailing performance. Stainless steel mounting shaft. Quick removal for trailering.

- CM7703 STD BRIDLE VANE
- CM7704 REPLACEMENT VANE
- CM7705 HOBIE FURLER ADAPTER



CM7705



CM7704



**TELO CAT WIND VANE**

Tough molded plastic vane. Rugged heavy duty stainless steel shaft with Teflon bearings. Tacking arms can be set to desired vane angle for optimum performance setting. Easy removal—no tools required. Fits Hobie 14/16.

- 377 TELO CAT
- 378 VANE ONLY

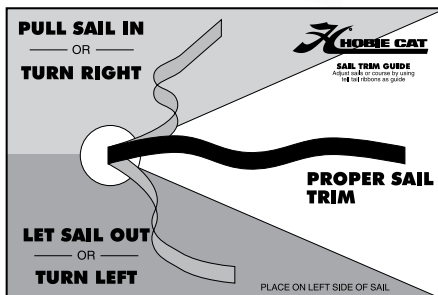
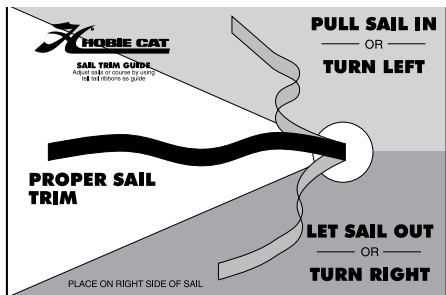

**AIR-FLOW TELS**

Trim your sails for optimum performance. Attached air flow over sails is critical. Air flow directions are indicated by these tell tails. Made of light weight rip stop nylon (Red / Green). Attaches to sails with waterproof adhesive disks.

- 334 SET OF 14



## HOBIE TRAMPOLINES

All of our HOBIE trampolines are heat welded rather than stitched for the ultimate in longevity and easy maintenance. There is no potential of UV degradation of thread or loose thread unraveling an entire seam. This is a HOBIE exclusive, longer lasting by far!! All include halyard pocket. Note: Hobie Class Association racing requires the Hobie Cat factory supplied trampoline. **See parts Guides and parts list for trampolines & available color options.**



### TRAMPOLINE DOUBLE GROMMET KIT

Hobie Cat doubled the number of grommets across the rear of the trampoline in 1983 to reduce stress and strengthen the trampoline. This kit includes 24 spur grommets and installation tools. Buy an additional 24 grommets to do the center lacing.

**2061** COMPLETE KIT  
**2062** 24 GROMMETS



HALYARD POCKET ON ALL TRAMPOLINES



### TRAMP LACING KIT

Many sailors prefer lacing their trampoline with shock cord. This kit includes three pieces of 3/8" nylon covered black coated nylon shockcord and 12 clamping rings. Fits the H14, 16, and 18. Not shown.

**2064** KIT

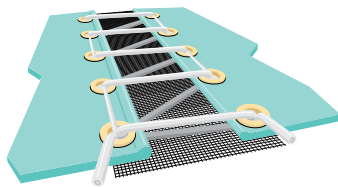

### MAINSHEET OVERBOARD PREVENTER

This neat little piece of mesh laces into the existing tramp grommets, filling the center gap that the mainsheet is forever falling through. Existing lacing does not need to be undone. Kit includes line for lacing the preventer.

**2067** 66 INCHES

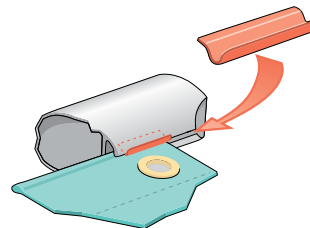

### TRENTEC™ TRAMP CLAMP™

Prevents trampoline from pulling out of aluminum extrusion. Increases trampoline life. Minimizes chafing of the trampoline at the critical stress points.

**2066** SET



### TRAMPOLINE DRINK HOLDER

You can add drink holders to your trampoline too! Requires a hole cut into the trampoline and stitching. Can be done by a sail loft or upholstery shop.

**1125** DRINK HOLDER

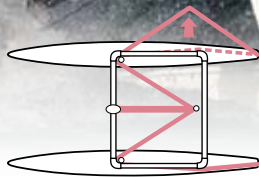
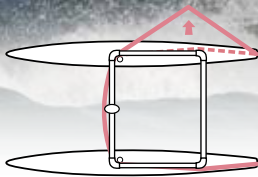

**EASY RITE**

Internal shock cord recoils this righting line automatically. Made from 1/2" hollow braid line with internal shockcord. It requires no blocks or shackles. Installs in minutes without tools. Also functions as crew safety line. Our best selling righting system.

- 30105 H14/16/17
- 30106 H18/21
- 30108 H20
- 30109 GETAWAY

**EASY UP**

Favored Hawaiian style righting line system and trapeze safety line. (H14/16 only.) Retracts fully—it's there when you need it and out of the way when you don't. No tools required to install.

- 30101 H14/16
- 30102 H18

**RIGHTING BUCKET**

Simple, easy to carry, and easy to use. Comes complete with no-rot canvas bucket, premeasured line, shoulder pad (not shown) and snap. The righting bucket holds as much as 150 pounds of water to assist your body weight to right your catamaran.

- 30107 KIT

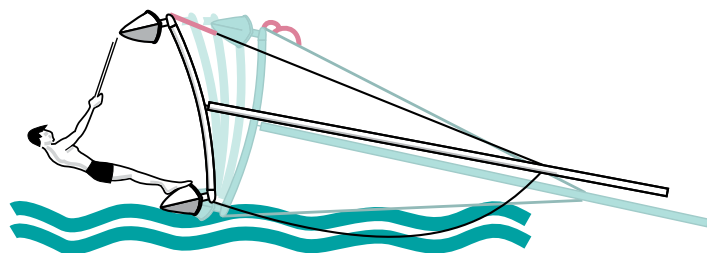

**THE UPRIGHT SOLO RIGHTING SYSTEM**

The Upright installs easily. No holes to drill, no measurements are needed. Attaches in five minutes to the existing shroud adjusters with a pair of pliers. Racing rules allow carrying the Upright for emergencies, but it may not be used while racing. The Upright is designed for a single reason, to make sailing your small catamaran safer.

- 1263 H16
- 1265 H17
- 1264 H18/20

**SHROUD EXTENDER**

Tension and de-tension shrouds easily for the "perfect" rig tension. Use in conjunction with "shroud extending" righting systems for complete re-tensioning while out on the water. Requires shrouds be shortened. Check class rules for racing.

- 10049 EACH



**ANTI PITCH POLE HYDRO FOIL**

A simple bow plane that attaches to the bow tang bolt. As the bow starts to dive the bow plane's 55 square inches of surface comes in contact with the water and halts the submerging of the bow before the deck goes under water. Easy to install or remove for racing. Makes sailing a lot more fun for the recreational sailor.

- 30110 H14/16 PAIR



**RESCUE STEP**

"How do I get back in if I fall out?" The RescueStep features quick and easy installation and operation for vessel re-entry assistance, righting an overturned kayak and can also be used to tow or portage your kayak. Its compact size makes it easy to bring along anywhere you need it.

- 72020092 RESCUE STEP KAYAK
- 1266 RESCUE STEP BOAT

## TECH TIP!

**RIGHTING YOUR HOBIE:** On that reach...flying through the air and water then...WHAM!!! Your Hobie Cat has forced you to swim instead of sail. Not really what you had in mind? If you have planned ahead you will be up and sailing again quickly. Whether sailing single handed or with a few friends, righting your boat can be quick and easy...

First, preventing your mast from becoming one with the bottom, or "turtling" is a priority. We at Hobie have designed mast floats to help keep your Hobie Cat from becoming a 'mudhen'. The floats attach to the top of your mast and will prevent the mast tip from sinking.

The next objective will be to get back to sailing! Righting systems vary a bit, but the theory is the same. A line is attached to your Hobie, thrown over the hull in the air and then weight (yours and or your friends) is used to lever the boat back to an upright and sailable position.

After you have checked that everyone is OK, turn your hulls and mast into the wind (see diagram) and uncleat your sails. You and your friend now need to congregate on the hull that is in the water. Grab the righting line, lean away from the trampoline and get as close to the water as you can. Try to stay out of the water. If you don't have enough body weight to right the cat we have the Righting Bucket! Just attach it to the boat, with the hook that is provided, throw over the upper hull and fill the bucket with water! With the bucket strap over your shoulder, lean your weight out from the boat. The bag comes clear of the water and up the cat will come!! Grab the dolphin striker or crossbar as it comes up, climb aboard, sheet in and GO!

Tipping your Hobie over can be a great way to cool off and enjoy the water... try it! It's excellent practice for when you weren't planning to go for a swim but your Hobie decided that you needed to cool off!

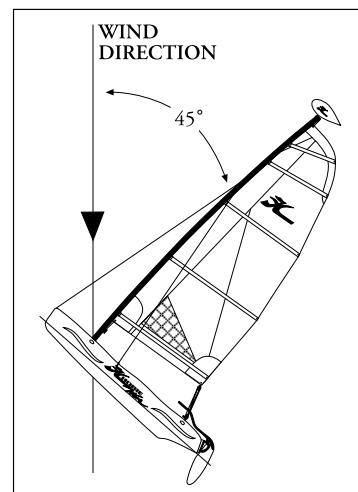

### MAST FLOAT "BABY BOB"

(Standard on the Wave) Designed by the Hobie Cat team to offer the safety and security of mast head flotation while limiting the resistance (drag) through the air. If you capsize, the Hobie mast float can give you the time you need to prepare to right the boat without the worry of going turtle (mast straight down). This also helps prevent damage to your rig and sails that can be caused if the mast comes in contact with the bottom when capsized. Great for Hobie 14 and Hobie 16 as well as others with mast head castings capable of bolting in a similar fashion. It is fixed in position to the mast head and rotates with the mast. Displaces 32 pounds of water and measures 1/2 cubic foot in volume. Bracket mounting allows easy removal for racing or trailering. Kit includes mounting brackets and fasteners.  
30115 WAVE, H14, H16



### MAST FLOAT "MAMA BOB"

Offers more flotation volume while using the same bracket mounting system as the Baby Bob shown above. Displaces 59 pounds of water (just under 1 cubic foot in volume). Mama Bob has nearly the same vertical dimension as the Baby, but it is wider. More volume further inhibits a boat from going turtle when capsized in rough and windy conditions. This is standard on the Getaway due to both weight and trampoline area which pushes the mast downward with more wind force when capsized. Extra volume, extra safety margin! Kit includes mounting brackets and fasteners.  
30119 GETAWAY



### UNIVERSAL MAST FLOAT

"Mama Bob" float incorporating a universal attachment system to fit a wider variety of mast configurations. This is a shaft mounting system originally conceived for the Hobie 21 Sport Cruiser. Can attach to any mast. This streamlined float is shaft mounted to the side of any mast and is easily removed for racing or trailering. This float is contoured and held in alignment with the mast for minimum drag while sailing. Includes shaft mount hardware and fasteners.

30112 FITS ALL CATS

### EPO3 RUDDER BLADES

This third generation rudder the EPO3 combines the original shape of the EPO2 rudder with an improved trailing edge. We developed the EPO3 rudder blade as the next generation performance rudder blade for the 14, 16, 17, 18 and 20. With this proven foil shape and a fine trailing edge, the EPO3 offers reduced cavitation with smoother, more forgiving control. The EPO3 rudder is stiff where it counts due to its hand laid fiberglass construction incorporating extra cloth for longitudinal stiffness. We have placed extra glass in all the right places to ensure that it is tough enough for the most demanding sailors using extreme mast rake. You will experience supreme performance and handling not found with other rudder blades. White EPO3: Gucci looks, stiff and light weight.

**20490030** EPO3 RUDDER BLADE - EACH



### DIE CAST GUDGEONS

Standard on current production Hobie 16s, these die cast aluminum gudgeons are now available for your Hobie 16, 17 or 18. Their one piece construction and plastic bushed pin holes guarantee pin hole alignment, reducing rudder pin wear, slop and drag.

**50102011** H16 EACH

**60102011** H17-18 EACH\*

(\*H18 Cast Gudgeon includes a rudder pin, cotter keys and washers.)



### LOCKING GUDGEON SCREWS

No more re-tightening gudgeon screws. As of 1996, Hobie Cat changed gudgeon screws on all new boats to "long lock" screws. Similar to a Nylock Nut, this screw has a nylon insert almost the full length of the threads. The nylon insert screws into the aluminum transom plate and provides the same resistance to movement that the nylock nut does.

**8030401** SCREWS, 12-24 LONG LOCK GUDGEON SCREWS

**PACK OF 16**

**8030402** SCREW, 12-24 LONG LOCK 1EA



### STAINLESS STEEL RUDDER PINS

Made from 3/8" stainless steel rod, these rudder pins are extremely durable. Sold Each.

**20880011** H14,16 EACH

**60880011** H18 EACH



### FIBERGLASS RUDDER PINS

Durable, wear resistant fiberglass rudder pins won't corrode in salt water. 3/8" diameter provides tight fit and eliminates some of the slop due to worn out gudgeons. Sold in pairs.

**5051** H14/16 PAIR

**5052** H17/18 PAIR

### STANDARD RUDDER PINS

Sold Each.

**10881000** H14 NYLON

**20880001** H14/16 ALUM

**60880001** H17/18 ALUM

### RUDDER CASTING BUSHING

Are you plagued by sloppy rudders? Do your nyliners keep slipping out? Open up the holes in your rudder castings to 7/16" and install these insulating, self lubricating nylon bushings.

**8062001** SET OF FOUR



### TECH TIP!

#### RUDDER RAKE

Excessive weather helm (when you must pull hard on the hiking stick to keep the boat from turning towards the wind) can be corrected by cocking the rudders farther (forward) under the boat. If you have too much lee helm (very little pull on the hiking stick, with the boat tending to turn away from the wind), this is corrected by unscrewing the adjustment and cocking the rudders back (aft). The amount of rudder rake needed depends on how far back the mast is raked and how much weight is being carried. The biggest problem with rudder adjustment is when a skipper changes the blade adjustment screw without reseating the cam plate in the upper casting. Even a very minor adjustment to the rudder could cause the cam to lock partially rotated, dramatically reducing the kick-up resistance. That means every time you make a blade rake adjustment, you must also reseat the plate AFTER you have finished adjusting the blade rake. There are three very important adjustments that should be made to the rudder assembly.



1. The rudder rake screw which adjusts blade angle.
2. The cam plate bolt which holds the blade forward.
3. The cam tension screw which adjusts kick-up tension.

When system adjustments are made improperly, the system won't work right. You must follow these steps in order!

1. Lift the rudder arm to unlock the assembly.
2. Using an allen wrench, adjust the rudder rake screw to give the desired rudder blade angle (rake).
3. Make sure that the blade is seated forward against the adjustment screw, loosen the cam plate bolt and lock down the assembly. Slide the plate back a little and then forward as far as it will go up into the cam. Retighten the bolt with a 1/2" socket.
4. Adjust the kick-up tension screw with a screw driver. You can calibrate the tension with a fish scale by making a loop of rope and putting it on the rudder blade about 24" down from the front bolt hole. Hook the scale to the loop and pull. Factory kick-up tension is set between 18-22 pounds.

**STANDARD HIKING STICKS**

See the part diagrams pages for the standard hiking stick to fit your model Hobie.

**ARRIBA "HOT STICK" HIKING STICKS**

Impact resistant fiberglass telescoping hiking stick. Cam shaped internal shaft locks outer shaft with simple 20° twist of handle. Uni-directional lock for smooth sliding action. No moving cam parts. Full length grip surface allows twist lock/unlock along entire length. Elastically coupled hinge is tough. Yoke for attachment to tiller cross bar is included.

- FX3 52"-96"
- FX4 57"-105"
- FX6 63"-120" (H17,18SX &21)

**CARBON WILD CAT HIKING STICK**

F99502360 EXTENDABLE

**WAVE HIKING STICK KIT (EZ LOC RUDDERS ONLY)**

Add a (tiller) hiking stick to your Hobie Wave! A tiller allows you to hike out or move your weight forward for better down wind speed. Standard tiller and hinge yoke included. For EZ LOC rudder system.

39550001 Wave Tiller Kit



**HIKING STICK SOFT GRIP**

This soft grip for your tiller extension eliminates "slippery stick". Twelve inches long, made of UV tolerant closed cell foam. Glues on.

- 3207 FX/Hot STICKS
- 3206 STANDARD TILLERS



**THIRD HAND**

This is the closest thing you can get to "self-steering" on a Hobie Cat. This handy little device grips the hiking stick, holding the tiller at whatever position you please. Great for light air sailing or when paddling in if the wind dies. It also keeps the rudders from flopping around when on the beach. Attaches at each end of the traveler track. For the Hobie 14 & 16 only.

204 PAIR

**BALL LOCK PINS**

Remove hiking stick from the cross bar for trailering or storage without the hassle of unwinding and dropping "ring-dings".

- 20303 ALUMINUM
- 20304 HOT STICKS



**TILLER CONNECTOR (HOBIE MIRACLE 20 STYLE)**

We've taken the tiller connection system for the Hobie 20 and adapted it to all of the Hobies. Now you can have the no slop, easy adjustment, 10 second assembly/disassembly convenience of the latest in tiller crossbar connection systems. There is no better tiller connection and adjustment available at any price! Now available in a version (1957) for Wave and Getaway (standard on newer boats / non-adjustable). Same easy release system.

- 1953 PAIR ALL BOATS
- 1957 PAIR WAVE/GTWY



**TILLER CONNECTION KIT**

Complete tiller linkage replacement kit. The contoured spacers fit snugly against the tiller end caps and crossbar alignment end cap to eliminate linkage sloppiness without spending a fortune. Includes all required parts.

3052 PAIR

**RUDDER CAM KIT**

Replace the rudder cam and flared pin with this kit that includes a pair of cams and a pair of binding post screws.

- 5202 H14/16
- 5204 WAVE, 17 and up (H18 '86 & up)



**RUDDER CAM SISTERSCREWS**

Replace your old flared pins with these reusable pins. No more riveting and drilling. These reusable binding post screws let you change rudder cams with the turn of a screwdriver. Sold by the pair.

- 5201 H14/16
- 5203 WAVE, 17 and up (H18 '86 & up)



**RUDDER STIFFENING KIT**

Beware of imitations! Features special high density polyurethane washers that will last and last. Highest quality components. These washers and stainless steel Nyloc nuts work great to give your rudders that tight fit. Eliminate wobble between rudder blade and upper casting. Don't settle for less—Get the ORIGINAL.

136 KIT

**KICK BACK KIT**

Returns rudders to locking position quickly and effortlessly. Really great when sailing in weed filled waters. Installs on the existing rudder bolts. Fits all Hobie 14's/16's. Class legal.

1544 KIT





### JIB TRAVELER CARS

For the integrated track crossbar on the Hobie 16! Standard equipment as of late 2005. This jib traveler is constructed of Zytel. Zytel is made of glass reinforced nylon which results in a very strong material. This resists fatigue and impact failure. Brass traveler bearings for easier movement under load. Includes holes for anchoring traveler and traveler return lines. See H16 parts diagrams for replacement parts.  
**25232201** PORT  
**25232211** STBD



### LO-PROFILE JIB BLOCK

For the Hobie 16 original SS Tracks. It is a basic swivel cam cleat with roller fairlead and Harken aluminum jaw cammatic, mounted on a stainless steel slide. It self aligns with the angle from which the sheet rope is being held for ease of cleating no matter where the crew is positioned. It's one piece, easy to install, light weight, low profile, interchangeable with left or right side and self aimed at the windward side of the boat. (Tracks vary slightly). May require prying open some tracks slightly  
**1075** w/ CAMMATIC  
**1076** w/o CAMMATIC

### TRETEC JIB TRAVELER CAR

Provides the super low profile needed with raked back masts. Slides in track easily. Can be used with bullet block shackled to sheet rope lead eye to reduce friction to a minimum. Requires traveler car trim system and sheet rope cam or lance cleat.

**1552** H16 PAIR FOR ORIGINAL SS TRACK  
**1553** JIB CARS FOR INTEGRATED TRACK



**1071**  
Swivel cleat system

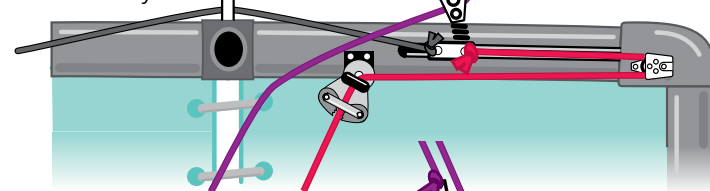

**1073**

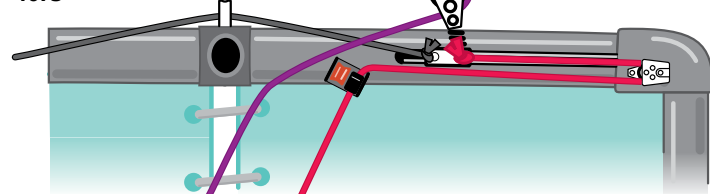

### JIB TRAVELER TRIM KITS

These traveler adjustment systems can be used while out on the trapeze. They work with all of the jib cars available. They can both be set up to self return the cars inboard or outboard. Color coded trim lines and all hardware are included. The 1071 kit with swivel cam cleats allow cleating and uncleating from any position on the boat. Lance cleats in the 1073 kit limit the location from which trim lines can be cleated.

**1071** KIT W/SWIVEL CAM CLEATS  
**1073** KIT W/LANCE CLEATS



### LANCE CLEATS

The lance cleat utilizes a single rugged aluminum alloy cam mounted vertically in a black molded frame. Just slide the rope sideways and it runs freely in the fairlead, which has a colored roller incorporated in the top for easier sheeting and identification. Ideal for use in confined spaces. For use with 1/4" line. The base size is 1/16" x 15/16". Height is 7/8".  
**R359S** STBD  
**R359P** PORT



### SWIVEL CAM CLEAT

Swivel cam cleats feature the Harken Cammatic Cleat. The Cammatic is matched with either the standard bullseye fairlead or the Roller Fairlead. The bullseye fairlead is available with either the plastic jaw Cammatic H365 or the aluminum H150. The roller fairlead is matched with the aluminum jaw H150 Cammatic only.  
**50007** EYE w/ H365  
**50009** EYE w/ H150  
**50013** ROLLERS w/ H150

**B323** DEAD EYE



### ROLLER FAIRLEAD KIT

Simple to install kit converts cleat arrangements that use "bullseye" fairleads to roller fairleads, reducing friction and line chafing. With all hardware. A screwdriver is the only tool needed. Accepts up to 1/2" line.  
**50012** KIT



### SWIVEL CAM CLEAT

HOLT ALLEN SWIVEL  
**50017** EACH  
**11901010** PAD

### SWIVEL CAM MOUNTING PLATE

Universal mounting plate for swivel cam cleats. High strength black Delrin® construction that is ultraviolet tolerant.  
**1161** w/o HARDWARE  
**1162** w/ HARDWARE





**HARKEN CAMMATIC CLEAT**

Rounded jaws assure quick cleating/release action and smoother teeth mean longer life for your sheets. Hardkote teflon impregnated die-cast aluminum cams and base with three rows of ball bearings provide a long lasting investment. Use with #50010 Adapter Plate for most change overs.

**H150** CLEAT ALUM JAW

1/8" to 1/2" line

**H365** CARBON MATRIX JAW

1/8" to 5/16" line

**HSB56** REPLACEMENT SPRING

Fits 150/365

**H471** MICRO CLEAT, CARBO JAW

1/8" to 1/4" line

Fairleads and eyestraps designed specifically for each Cammatic model, the wedges put the Cammatic on a 15 degree angle for ease of cleating or releasing. The fairleads are molded into a replacement base for each Cammatic. The eyestraps are designed to be held in place over the cams by the mounting screws.

**WEDGE KITS**

**H145** (H150 & H365)

**H297** (H471)

**WIRE FAIRLEADS**

**H298** (H150 & H365)

**H284** (H471)

**EYESTRAPPS**

**H137** (H150 & H365)

**H201** LOW (H150 & H365)

**H281** (H471)



**ADAPTER PLATE**

Universal mounting plate that allows you to add the Cammatic Cleat to nearly any cleating system now in use. Includes mounting hardware.

**50010** KIT



**H2640**



**H194**

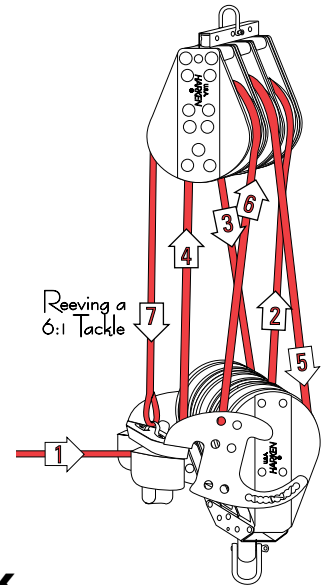

**HARKEN 2 1/4" BLOCK LOW PROFILE 6:1**

Successful racers have gone to super low profile systems on Hobie 16's (6:1) and 18's (7:1). This allows the sailors to achieve more mast rake for better pointing ability and reduced pitch pole tendency. They are using the Harken 2 1/4" ratchet block and boom blocks with 3/8" line. The lower block is customized to allow the post to enter the traveler car hinge plate on the Hobie 16. To convert to 7:1, H18 sailors add a mini-block to the eye that's normally used to tie off to and then tie the line off on an empty boom bail.

New Hobie 16s come with H194

Lower ratchet and H2640 Carbo upper.

**H2640\*** UPR 40mm CARBO

**H194\*** LWR 2.25" BLOCK

\*use 3/8" sheet rope for smooth flow of line through blocks.

**H125** MINI BLOCK (to 7:1)

Note: add 8' to sheet rope length when converting to 7:1 system.

**TRAVELER TAMER™**

Travel Tamer™ replaces the plastic sheaves on the traveler car with larger, ball bearing rollers to reduce friction.

**50014** TAMER



**HOBIE CLUB WAVE MAIN TRAVELER KIT**

Upgrade any Wave Club model to have a main traveler system. The addition of a main sail traveler will offer better sail control in higher winds and down wind sailing angles. Helps to limit heeling in higher winds while optimizing speed potential. Also reduces loads on the bows, therefore reducing the amount of dive or pitch pole potential. Go faster with better control! Kit includes deep profile traveler track, rivets, #111 brass wheel traveler car, swivel cleat, mount and instructions.

**39250000** CLUB WAVE MAIN TRAVELER KIT



**TECH TIP!**

**BOAT CHECK LIST**

There are a number of items to check on your boat. Do this on a regular basis and before sailing for the first time each season. Here are a few of the basics...

**STANDING RIGGING (wires)**

Check for broken strands. Inspect and slightly bend at all fittings to find broken strands (replace if needed). Check all clevis pins and keepers.

**HARDWARE**

Check for bent or damaged shackles and other components.

**LINES**

Check for wear.

**HULLS**

Check for leaks and possible structural problems. Delamination of the hull structure could lead to major failure.

**MAST**

Check mast and all aluminum spars for corrosion and other damage. Corrosion can cause structural failure.

**RUDDERS**

Check the cam lock-down system. This should be free of dirt and sand. Grease regularly to allow free rotation motion.

**DRAIN PLUGS!**

Need we say more.



**HARKEN MICRO BLOCKS**

Small blocks with high load capabilities, but light weight. Accepts up to 1/4" line, 1200 pound load, 7/8" diameter sheave.

- H224** SINGLE
- H225** SINGLE w/ BECKET
- H226** DOUBLE
- H227** DOUBLE w/ BECKET
- H228** TRIPLE
- H231** \*TRIPLE w/ BECKET & CAM
- H232** TRAVELER (\*not shown)
- H233** CHEEK
- H244** FIDDLE MICRO

**HARKEN BULLET BLOCKS**

Medium size blocks that work well for control line or jib sheeting lines. Accepts up to 5/16" line, 2000 pound load, 1 1/8" diameter sheave.

- H082** SINGLE
- H083** SINGLE w/ BECKET
- H084** DOUBLE
- H092** CHEEK
- H166** SINGLE w/ SWIVEL
- H167** SINGLE w/ SWIVEL & BECKET
- H353** TRAVELER



**HARKEN 16MM AIR BLOCKS**

Harken's newest small blocks for control lines. Accepts up to 7/32" line, 900 pound load, 5/8" sheave diameter. Ultra light weight.

- H404** SINGLE
- H405** SINGLE W/BECKET
- H406** DOUBLE
- H407** DOUBLE W/BCKT

**AUTO RATCHET BLOCK**

BY RONSTAN

Perfect for spinnaker sheet turning blocks. This Ronstan block is free wheeling at low wind velocity. As the wind velocity increases the pressure on the sheave automatically engages the ratchet. The sheet rope is never trapped in the sheave and can slide out the same as any other ratchet block without first pulling in and then releasing. 55mm sheave.

**RF56100** AUTO RATCHET

**HARKEN BIG BULLET BLOCKS AND DINGHY BLOCKS**

Big blocks accept up to 3/8" line, 2000 pound load, 1 1/2" sheave.

- H125** SINGLE
- H126** SINGLE W/BECKET

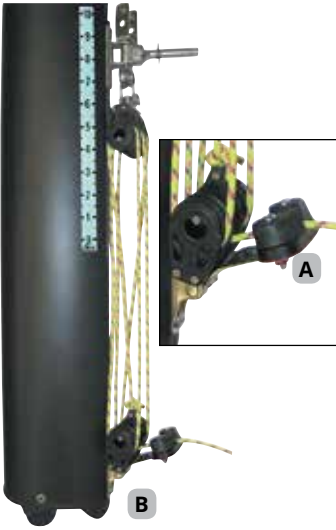

**A 6:1 DOWNHAUL KIT**  
Downhaul system for Hobie 14 and 16. Now Class Legal. Kit comes complete with Harken carbo triple block and triple with cleat. Includes class approved attachment for base of mast, all hardware and line. Use with the gooseneck slide kit # 1511.  
**2089 6:1 KIT**

**B DOWNHAUL SCALE**  
Can you ever remember where the downhaul was set that day you "smoked" everyone. This handy stick on scale takes the guess work out of setting the downhaul.  
**2082 EACH**

**POWER PAK**  
6:1 Downhaul , 2:1 Outhaul systems for Hobie 14 and 16. Rotation control for H14. Jib halyard upgrade for H16.  
**2090 H14 POWER PAK**

**2091 H16 POWER PAK**



**DOWNHAUL/HALYARD SHEAVE**  
Ease raising the sail and/or adjusting the downhaul with Harken ball bearing sheaves. They really make the job a whole lot easier. A direct replacement for the sheaves that came with the early Hobie 17's.  
**H160 EACH**



**H228**



**H231**

**HARKEN TRIPLE W/BECKET & CAMMATIC**  
Perfect for H16 or H17 downhaul.  
**H231 EACH**  
**H228 EACH**

**EYE STRAP FOR BOOM VANG**  
Heavy duty eye strap for connecting boom vang at the mast base rather than at the trampoline slot in the cross bar.  
**2072 w/ FASTENERS**



**TRENTEC SUPER GOOSE**  
Adds convenience and security of attachment at the boom to mast connection. Replace the vertex that connects the boom pin to the gooseneck yoke assembly on the mast. Custom made for the Hobie 18, machined from a block of 6061-T6 aluminum and hard coat anodized. Will not bend and open up no matter how strong the wind. Go a step further and permanently secure the clevis pin that connects that Super Goose to the boom pin with a cotter key. Replace the nut and bolt connecting the vertex to the mast yoke with a 20304 ball lock pin.  
**1510 EACH**



**GOOSENECK BEARING**  
Eliminates drag and prevents gouging the gooseneck slide on Hobie 14, Hobie One-14 (Holder) Monohull and Hobie 16 luff track. Delivers a fantastic improvement in downhaul adjustability!  
**1511 KIT**

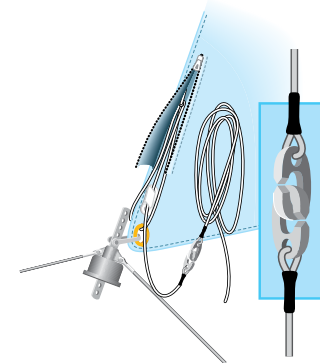

**L'IL SISTER CLIPS**  
The answer to "What to do with all the jib halyard?" L'il Sister Clip speeds the untie and retie of your H18 jib halyard. Includes both segments of jib halyard.  
**CM7732 SET**



**HALYARD GRIP**  
Keeps those halyards close in to the mast and out of the way so that the jib doesn't hang up on them. Molded from strong Delrin and contoured to the curve of the mast. One on each side of the H16 mast does the trick.  
**114 EACH w/ HARDWARE**



**HOBBIE 16 "AUSSIE" JIB HALYARD**  
Reduces mast compression which allows easier tacking, better mast rotation and consistent mast bend! Complete kit includes hardware, 70' (Dyneema® or equivalent) halyard line, zippered pouch, and instructions. Racing class legal.  
**80660000 KIT**



**HOBBIE "AUSSIE" HALYARD RING**  
The Aussie Halyard Ring makes engaging and disengaging the halyard ring from the halyard hook a real snap. This device helps to keep the ring aligned with the hook. Welded one piece design has a clevis pin that is drilled, so a clevis ring can be added to keep it locked to the sail.  
**3064 EACH**



### BOW SHACKLE - THREADED PIN

Part #	Pin Dia.	Width	Length	Max Ld#
SP150061	1/4"	9/16"	15/16"	4400



### "D" SHACKLES - THREADED PIN

Part #	Pin Dia.	Width	Length	Max Ld#
SP150041	5/32"	3/8"	5/8"	1100
SP150051	3/16"	1/2"	11/16"	2640
SP150052	3/16"	5/8"	15/16"	2640
SP150053	3/16"	5/8"	1 7/16"	2640



### SAFETY SHACKLE WITH 1/2 TURN CAPTIVE PIN

Part #	Pin Dia.	Width	Length	Max Ld#
SP185205	3/16"	1/2"	1"	2640
SP180005	3/16"	5/8"	1 7/16"	2640
SP180006	1/4"	7/8"	1 5/8"	4400



### TWIST SHACKLE WITH 1/2 TURN PIN

Part #	Pin Dia.	Width	Length	Max Ld#
SP170005	3/16"	1/2"	7/8"	2640
SP170006	1/4"	9/16"	1 3/8"	4400



### SWIVEL SHACKLE

Complete with clevis & split rings. Align blocks, Fittings, etc. B-094 is extra heavy duty.

**Part # Pin Dia. Width Length Max Ld#**

**B094** 1/4" 1/2" 11/2" 1000



### FAST SHACKLE

The Fast Shackle was created for the jib clew blocks on the Hobie 16 & 18. It's a halyard shackle and an Avibank ball lock pin permanently wired to the shackle so it won't drop in the drink when the blocks are released from the jib clew.

**3062** EACH



### SNAP SHACKLE

Makes it easy to remove expensive mainsheet systems from your boat when it's parked on the beach or for ease of take down and set up for trailering.

**20803** EACH



**SPARE PARTS - ALL PACKAGED IN 12" ZIPPERED POUCHES**

	H14	Wave/Get	H16	H17	H18	H20
Shackle tool	•	•	•	•	•	•
2 Drain plugs w/gskts	•	•	•	•	•	•
Pair of rudder pins	•	•	•	•	•	•
Clevis pin set	•	•	•	•	•	•
3/16" Bow shackle	•	•	•	•	•	•
1/4" Bow shackle	•	•	•	•	•	•
Twist shackle						
Mast bearing(s)	•		•		•	
3 Batten tie lines	•	•	•	•	•	•
1 Ft. sail repair tape	•	•	•	•	•	•
<b>Part #:</b> 303-	<b>05</b>	<b>08</b>	<b>06</b>	<b>14</b>	<b>07</b>	<b>20</b>

**KEEPER PINS**

Great little helpers for quick rudder removal. Forget the aggravation of straightening those cotter pins! A definite plus for trailering. Stainless Steel.

**20501** 5/16" DIAMETER

**20502** 3/8" DIAMETER

**20503** SAFETY PIN



**BALL LOCK PINS**

Take the hassle out of rigging and de-rigging your boat. Replace 3/16" and 1/4" clevis pins that use ring dings with easy-to-use push button pins. These "quick pins" are usable in a variety of places on your boat and will not work free by themselves. Use them anywhere a clevis pin can be used! Caution is advised when using these for standing rigging as some inspection or maintenance of the ball lock system may be required to avoid a de-masting.

**BALL LOCK PINS**

	FSTAY SHRDS	HIKING STICK	OUTHHAUL	GOOSE-NECK	TRAVELER CAR	JIB TACK
<b>20301</b> 3/16"x3/4" Cup Head					<b>14,16,17</b>	
<b>20302</b> 1/4"x3/4" Cup Head	•		<b>18,21</b>			
<b>20303</b> 1/4"x1 1/4" Ring Hd		<b>Std</b>				
<b>20304</b> 1/4"x1" Ring Head				•		
<b>20305</b> 1/4"x1" Cup Head				•		
<b>20306</b> #20305 w/Tack shackle & lanyard			<b>20</b>		<b>18,20,21</b>	•
<b>20307</b> 1/4"x1 1/2" Cup Head		<b>Extendables</b>				
<b>20311</b> 3/16"x3/4" Ring Head	<b>Old H14</b>			•	<b>14,16,17</b>	
<b>20312</b> 1/4"x3/4" Ring Head	•					
<b>20313</b> 3/16"x1/2" Ring Head					<b>14,16,17</b>	
<b>20314</b> 1/4"x1/2" Ring Head	•					
<b>20310</b> 8" X 1/16" Wire Keeper with NicoPress Sleeves						



**CONVENIENCE PARTS**

	H16	H17	H18
QR Pin for forestay adjuster	•		
Fast shackle or jib tack shackle	•		
Quick release pin for main traveler car	•	•	
Quick release pin & shackle for main traveler car			
Quick release pin for hiking stick	•	•	•
Shockcord hooks(4) for trapeze shock cord	•	•	•
Quick release pin for outhaul		•	•
Quick release pin for boom to mast		•	•
Safety pins for rudder pins	•	•	•
<b>Part number: 303-</b>	<b>11</b>	<b>15</b>	<b>12</b>

**CLEVIS PIN ASSORTMENTS**

For Hobie Wave, Getaway, 16 and late model 14. Kit contains appropriate 1/4" clevis pins, 3/16" clevis pin for traveler car, 1/4" clevis pin for mast step link. Split rings are included.

**30303** H16/14 SET

**30302** WAVE/GETAWAY SET



**CLEVIS PIN ASSORTMENT**

For Hobie 17/18. Kit contains 4 each 1/4" clevis pins and 1 each 1/4" headless clevis pin for mast step. Split rings are included.

**30304** H18 SET

**30317** H17 SET

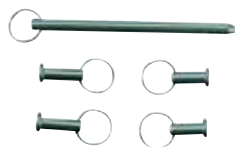



**SUPER LOW STRETCH LINE**

For Halyards, Trapeze adjustment and trampoline laces. Pre-stretched polyester line with superior fatigue and abrasion resistance. Our line (3/16"-3/8") tested as the lowest stretch (.5%) of any all polyester line available. Sold per foot.

- RH112WHT** 1/12" WHITE
- RH018WHT** 1/8" WHITE
- RH316WHT** 3/16" WHITE
- RH014WHT** 1/4" WHITE
- RH516WHT** 5/16" WHITE
- RH038WHT** 3/8" WHITE



**SPUN DACRON**

Best for sheets. Soft matte finish rope. Runs well thru blocks and fairleads, has good abrasion resistance, is spliceable and easy to hold with wet hands. Available in white, black, red, blue. This rope is not designed for winching. Sold per foot. Specify color choice.

- (White, Blue, Red or Black xxx = color)
- RM014WHT** 1/4" WHITE
  - RM014XXX** 1/4" COLOR
  - RM516WHT** 5/16" WHITE
  - RM516XXX** 5/16" COLOR
  - RM038WHT** 3/8" WHITE
  - RM038XXX** 3/8" COLOR
  - RM716WHT** 7/16" WHITE
  - RM716XXX** 7/16" COLOR



WHT



BLU



RED



BLK

**SUPER STRETCH SHOCKCORD**

This midnight-black shockcord has double the stretch of ordinary cord. If you've been getting your shockcord from the hardware store, you're in for a treat. The durable black cover is woven around an extra-flexible rubber core.

- RS018BLK** 1/8"
- RS316BLK** 3/16"
- RS014BLK** 1/4"
- RS516BLK** 5/16"
- RS038BLK** 3/8"
- RS716BLK** 7/16"

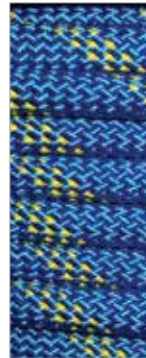

**RONSTAN DINGHY LIGHT**

The ultimate dinghy sheet and multi-purpose rope. Dinghy Light is a rope made of an XLF core/sheathing weave. It is used wherever low water absorption is crucial, making it particularly recommendable for use as a light-weight spinnaker sheet.

The sheathing made of XLF is a 40-plait weave offering excellent abrasion resistance. For the core, an 8-plait weave is used, making the rope round and compact.

Sold per foot. Colors may vary.  
**8004651** 1/4" / 6mm (H16 Jib 32' required)

**8004631** 5/16" / 8mm (H16 Main 44' required)



**ROBLINE**

Constructed as a hollow-fiber plait, made of impregnated polyamide and Dyneema® SK 75. These materials make the rope extremely abrasion-resistant and low stretch. The sheet is easy to grip, even when wet, and is easy to splice. Tigers: 5mm for spinnaker halyards / 8mm for spinnaker sheets

**RF05BW** ROBLINE 5mm BLUE/WHITE

**RF08BLU** ROBLINE 8mm BLUE/WHITE

**AMSTEEL**

High modulus Polyethylene (aka SK75 Dyneema) 12 strand single braid and is urethane coated for maximum performance. Used for H16 Aussie Halyard. Its tolerance to abrasion is excellent and it is resistant to degradation from ultra violet. This line will also float and has zero water uptake. Color may vary.

**8004951** AMSTEEL



**ONE WRAP VELCRO®**

Cut this double faced Velcro® product to length and wrap it around items, line or whatever you need to secure. One side is hook and the other a loop, so a single piece is all you need.

**7904** One Wrap, per foot



2101



2102

**SHOCKCORD SNAP HOOKS**

Easy to install shockcord snap hook. No tools required. Reusable!

- 2101** HOOK-1/4"
- 2102** HOOK-5/16"



### HOBIE TWIST AND SEAL HATCHES

TWIST AND SEAL HATCHES have a better seal. The lids also hinge open, so you never lose the lid. Designed with a cork-screw-like mechanism for closure, a simple twist of the handle opens or closes the hatch. As the screw pulls down the hatch, you get a tight seal on the "O Ring". The round hatch seals around the edge of the cylinder and does not have to be held down against a flat surface to seal. This allows the hatch to seal even if the lid is partially open or tipped. Flip the handle into the recess to "lock" it closed. Available in 6" and 8" diameters. \*Retrofit kits include gaskets (and 2 ea #8031130 screws for the 8").

- 71701011 6" TWIST AND SEAL HATCH
- 71321001 6" MOUNT GASKET
- 71702011 8" TWIST AND SEAL HATCH
- 71331001 8" MOUNT GASKET

- 71707001 HOBIE RECTANGULAR HATCH
- 71707002 FLANGE GASKET
- 8032121 SCREWS (RECTANGLE REQ 14)



### HOBIE RECTANGULAR HATCH ACCESSORIES

Add a drop-in "storage box" to your Hobie rectangular hatch or tackle management tray that deploys two tackle boxes as you open the hatch.

- 71709001 HOBIE RECTANGULAR BUCKET
- 71708001 HOBIE TACKLE MANAGEMENT

### HOBIE 6" TNS HATCH BAG

Add a drop-in bag to the 6" Hobie Twist-and-Seal hatch. Kit includes required back-up ring with lip, screws and bag with drawstring. (Available for 6" hatch only)

- 5421 6" HOBIE BAG KIT



### HOBIE SMALL ROLL TOP DRY BAG

8" diameter x 14". This dry bag is built of tough materials. Seals tight to keep your stuff dry.

- 71703001 8" HOBIE DRY BAG



### SEE BAG

Transparent 13 oz. vinyl bags make quick work of locating things. Great for organizing gear and personal stuff. Keep your food and spare clothes dry. Easy to carry or tie onboard. Its cylindrical shape will hold odd shapes such as cameras, binoculars, lunches, etc. without distortion of bag and resultant potential leakage.

- 72210T SEE BAG (8" x 14" 622 cu.in.)

- 72230TSEE BAG (11" x 19" 2200 cu.in.)



### SCREW-IN LID HATCH COVER KITS

Provides access to the hull for storage and inspection. All sizes have screw-in covers. The 4" and 5" diameter covers are contoured to fit curved decks. The 6" is flat and can be used to replace the pop out covers on the Hobie 18. Kits include one pair of hatch covers, bedding material and mounting hardware.

- 5352W 4" KIT-WHITE
- 5352B 4" KIT-BLACK
- 5351W 5" KIT-WHITE
- 5351B 5" KIT-BLACK
- 5353W\*6" KIT-WHITE
- 5353B\* 6" KIT-BLACK

\*Use 5403 or 5413 with 6" screw-in kit.

### HATCH BAGS FOR SCREW-IN LID HATCHES

Water repellent, durable nylon hatch bags provide secure storage of your wallet, keys, tools, etc. while sailing. Designed to work with screw-in lid type hatches with lip (Kit #5351B-5353W and hatch #V1093-V1146). Simply drop in and they hang from the lip of the hatch cover ring. Available in two styles: the cat bag is a standard cylindrical shape and the fat bag expands to the shape of an inverted hot air balloon.

- 5402 4" CAT BAG
- 5401 5" CAT BAG
- 5412 4" FAT BAG
- 5411 5" FAT BAG
- 5403 6" CAT BAG
- 5413 6" FAT BAG



CAT BAG

FAT BAG

### GUSSETED STOW BAG

Our 6" by 12" gusseted tramp bag rises to the occasion. It has hooks on both ends to clip to your boat and carries the Hobie logo. Also available in 8" x 12" size. Securely stow tool, gloves or small parts for easy access on board your boat.

- 72000B 6"x12" GUSSETED TRAMP BAG
- 72005B 8"x15" GUSSETED TRAMP BAG



### TRAMPOLINE STORAGE BAG

The Trampoline Storage Bag is designed to store loose items you want to carry on your catamaran. Low profile to eliminate line hang-ups. Designed to attach between the hiking straps. One compartment (18" x 36"). Includes a clear plastic map pocket. (Built of tough Cordura fabric, not waterproof.)

- 3128 WITH MAP POCKET



### ROLLING DUFFLE/GEARBAG

Back by popular demand. Great travel bag. High volume allows you to bring it all!

- 80000R ROLLING DUFFLE/GEARBAG



# HOBIE-TRAILEX ALUMINUM TRAILERS

## TRAILERS

Anodized aluminum trailers by Trailex, custom designed for Hobie. The best trailers for light weight and long, low maintenance, life.

**Getaway / H16 / Tiger trailer** (Pictured here) is shown with optional double rollers. Includes forward mast stand. Rollers or cradle attachment hardware is optional. Double roller kit is recommended for Getaway, H16 and similar cats. Cradle attachment kit is recommended for Tiger or other cats to 18' using cradles. Order roller kit, cradle attachment kit and cradles separately. An optional rear mast stand is also shown.

**Wave / Bravo trailer** has single rollers and carpeted bunk guide pads for the hulls to rest on, does not include a forward mast stand (Optional, order separately).

38653000

### TRAILER HOBIE GETAWAY / H16 TIGER / WILD CAT

(Shown with options: rollers, pads and rear mast stand)

38651200

Rear Mast Stand  
Optional

*NOTE: Loads may require a red warning flag if over hanging lites by over 4 feet.*

1 7/8" Coupler

38651000 HOBIE-TRAILEX Trailer WAVE / BRAVO

38651100 FORWARD MAST STAND

38653000 HOBIE-TRAILEX Trailer GETWY, 16, TIGER, WC

38653100 HOBIE-TRAILEX DOUBLE ROLLER KIT

38651200 REAR MAST STAND

**Trailer prices DO NOT include freight to dealer or assembly costs.**



## HULL CRADLES

For hulls, cradles distribute the loads over a larger area of the hull to reduce stresses while trailering or using Cat Trax. (Includes installation hardware to mount the cradles to a 2" diameter tube or roller).

1624 UNIVERSAL SHAPE - pair

38653200 HOBIE-TRAILEX CRADLE ATTACHMENT KIT is required to adapt the Trailex trailer to 2" diameter rollers (4) which enables 1624 cradle attachment / use. For use with 2 sets of 1624 (4) cradles.

## HOBIE TIE DOWN STRAPS

Rack tie-down straps, made of durable black polypropylene webbing. Diagonal cut and ironed ends make threading ends into buckles easier.

72042001 TIE DOWNS 12' (Pair)

72043001 TIE DOWNS 15' (Pair)



MK0046 HOBIE CAUTION FLAG



## SAIL STORAGE BOX "TOY BOX"

The original Toy Box! Made by roto-molding as one seamless piece with molded-in graphics. Big enough to hold two sets of Hobie sails, booms, daggerboards, rudders and have room left for odds and ends. The bottom is ribbed to allow wet things to drain. There is full access from front and back, even with the boat on the trailer. Mounting hardware is not included. This storage box doesn't care if you sit on it, fill it full of rocks and drop it from 10' or however else you brutalize it. It's tough. Length 10' 4", Width (rear) 21", Depth (rear) 13", Width (front) 19 1/2", Depth (front) 10", Weight 55 lb

**Prices DO NOT include freight to dealer.**

1825WHT ONE PIECE SAIL BOX



### TIE DOWN STRAPS

This outstanding four strap system features patented over center cam action locking buckles coupled with super-strong 2000 lb. test web straps and hooks. The tie downs secure your boat to any trailer in seconds. Full 1 year warranty on all parts. Custom Tie Downs come complete with all mounting hardware and instructions.

1791 WAVE TIE DOWNS

1793 H14/16

1794 H17/18



### "ACROSS THE HULLS" TIE DOWNS

One piece tie downs with hooks (and retainers) at each end and paddle handle buckle for easy adjustment. Each tie down is 2" wide by 13' long.

1795 EACH



### SHOCKCORD BALL TIES

Lashing the wires to your mast for trailering is quick and easy with this handy tie-down. Use a couple to keep your jib furled on the beach and your sails rolled in the bag. Dozens of other uses.

370 EACH



WAVE

### WAVE MAST TIE DOWN KIT

Includes fiberglass support and shockcords necessary to secure mast to the boat while trailering. Quick and easy to use. (Use of forward holder on Wave SE tramp requires modification, addition of one grommet in forward edge of trampoline).

38650031 Aft only

38650041 Set fits mast in 2 sections as shown above



### HOBIE MAST CRADLE

Molded to the shape of the rear cross bar and carpeted to protect the mast and cross bar. Includes a simple single shock cord tie down that secures the cradle to the cross bar and the mast to the cradle. Mast Cradle for Hobie Wave, Getaway, 14, 16, 17, 20 & 21SC

3175

### HOBIE MAST STEPPER

This system has a gin pole that rests on a foot attached to the trailer. The mast is stabilized by tying a trap wire on each side to the front cross bar. Attach the trailer's winch (not provided) to the forestay and hoist away. Utilizes bridles to stabilize the gin pole while hoisting the mast.

3152 MAST STEPPER

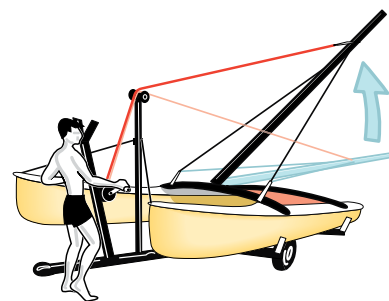

### MAST STEPPER II

Easy to install because it eliminates the trailer mounted gin pole. However, the Mast Stepper II system does require that the trailer's forward mast support be 30" taller than the mast step. The mast is stabilized by tying a trap wire on each side to the front cross bar. The kit includes all necessary lines, shackles, blocks and instructions. Purchase winch separately.

3155 MAST STEPPER II

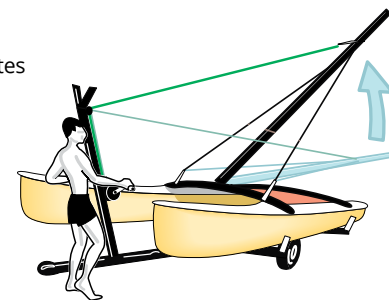

### HOBIE MAST STEPPER III

Specifically designed for the Hobie Getaway due to the rotated mast position when stepping. Step your mast with ease and safety. Specially designed bracket attaches to mast at base. A pole plugs into the bracket to create a gin pole arrangement that allows you to singlehandedly raise and lower your mast. It uses the trailer's winch (not provided) for power. Lines snap in place to eliminate side-to-side sway. Attaches quickly without tools. No modifications to boat. Can adjust to fit other rotated-position stepping masts. May also be modified to work on Hobie 17, Tiger and 20 (no instructions are provided for this modification).

3156 HOBIE MAST STEPPER III

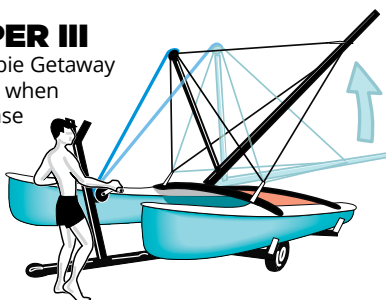

### TECH TIP!

**Mast Stepping:** Usually a two person job. For those days you need help, want to single hand or be able to rig the boat alone for any reason, a mast stepping aid is what you need. The primary function of a mast stepping aid is to raise the mast while restraining side movement induced by a cross wind. Often it is more difficult to handle the side motion than it is to raise the mast. It's the side motion that breaks or bends the hinges and/or mast base castings.

**NOTE: ADDITIONAL FREIGHT CHARGE ITEMS**

Carts and Trax items shown on this page incur additional freight charges.



CAT TRAX

**CAT TRAX** Cat Trax is the dolly for moving catamarans over sand, mud, rocks, or any surface. Lightweight and rustproof. Fast and simple tiedown attachment. Your cat rolls effortlessly on smooth running low friction Delrin® bearings. Jumbo 11" x 21" balloon tires disperse weight, don't dig in on soft surfaces. Tough padded end-caps hold the boat in line. Cradles not included except as noted.

- 1630 WAVE - 7' BEAM (Includes Axel pad and end caps)
- 1621 CATS TO 8' BEAM (Includes Axel pad and end caps)
- 1622 HOBIE 20/21SC (8'6" beam / Requires added cradles) (H2O add cradles #48010001, All others add cradles #1624)



H16 Dolly

**DOLLY** This dolly includes a handle so you can easily slide the cart under the boat and push or pull along holding the handle. Box tube aluminum frame and air inflated tires. Frame has dual contact points / crossbars, so hull is balanced on the cart. (Wheels: \*Two / \*\*Four)

- 90870000 BRAVO DOLLY \*
- 39870000 WAVE DOLLY \*
- 70000111 H16 DOLLY \*\*



TRAX

**BLUE TRAX** The "hard wheeled" version of the all time favorite catamaran beach dolly. Wheels that never need air so they won't go flat. Features the same needle bearings as the Cat Trax. Light weight.

- 1626 BLUE TRAX (8' BEAM)
- 1625 BLUE WAVE TRAX (7' BEAM)

**TECH TIP!**

**Boat Covers:** Boat covers are designed to protect your boat from UV degradation and dirt. Universal storage covers are one piece and designed for easy installation. They fulfill their purpose mast up (with minor modification) or mast down, on the beach or on the trailer. The fabric is woven polyethylene that is film coated on both sides to cover the woven fabric. It has fantastic tear resistance and is specifically designed for outside use. UV tolerance is one of its major attributes.



H2O Cradle Shown

**HULL CRADLES-BEACH DOLLY**

Cradles distribute the boat load over 400 sq. in. of the hull to assure there are no excess stresses while carrying. 48010001 is custom molded for the H20 hulls, Fits P18.2, P19, Nacra 5.2 & 5.8 also. Fits all popular beach dollies.

- 48010001 H2O PAIR
- 1624 ALL OTHERS PAIR



TRAX "T" HANDLE

**TRAX ACCESSORIES**

- 1623 T HANDLE - ATTACH TO AXLE (SHOWN ABOVE)
- 1620 END CAP-EACH
- 1635 REPLACEMENT CAT TRAX WHEEL ASSY
- 1636 REPLACEMENT BLUE TRAX WHEEL ASSY



**UNIVERSAL COVERS** Designed to fit a variety of boat lengths, cut into general catamaran shape. It's made of tough woven polyethylene that is coated on both sides, one side silver, one side white. We've chosen this polyethylene because of its excellent resistance to ultra-violet degradation. It is a woven rather than sheet fabric to provide great tear strength. These covers will tolerate sun, wind, rain, high and low temperatures. Install with silver side out.

Each cover is cut to be used for a boat length range. Tapes are sewn in place to allow you to secure the cover around the hulls and crossbars. Custom features such as cut outs or slits for wires or wings can be created with scissors. We include 5 feet of adhesive backed velcro with each kit to be used to prevent openings from flapping in the breeze.

*These covers are not designed to be used while trailering.*

- 314-13ALL HOBIE WAVE
- 314-14TO17 14' TO 16'8" RANGE
- 314-16-GTWY GETAWAY
- 314-17TO18 17' TO 18' RANGE
- 314-19TO20 H2O



- F99267585 TIGER CUSTOM COVER
- F99267635 WILD CAT CUSTOM COVER

## DELUXE HOBIE SAIL BAG

Stop fighting with your sail and boom cover. This sail and boom bag zips full length for ease and convenience and will fit any Hobie sail and boom. Full ventilation on each end with vinyl coated mesh. Added convenience with a separate compartment for line and blocks. Made with nylon Cordura®, includes double shoulder straps for maximum ease while carrying. Ends unzip to extend for extra long parts (Color may vary).

3121 DELUXE SAIL BAG



## STANDARD SAIL AND BOOM BAG

Pulls over boom and sail like a sock. Open end closes with a drawstring and nylon clasp. Material and color may vary.

21310000 STD 9' 5"

38990050 WAVE



## DAGGERBOARD COVER

Protect those daggerboards! This two pocket, woven polyethylene lined cover is padded and has a tough, Cordura (600 denier) outer material. It has carrying handles and velcro closures. Very important for preventing dings, gouges, and scrapes while storing and trailering. This is an absolute must for the racer. Room for two daggerboards. Style and color may vary.

72410001 TIGER/FOX/FXONE



82410020 H2O DAGGER COVER



## WILD CAT DAGGERBOARD / RUDDER COVERS

Protect those boards! This is an absolute must for the racer.

F99268017 WILD CAT DAGGER BOARD COV (FITS 2 LG BOARDS)

F99268010 WILD CAT RUDDER COVERS (PAIR)



## RUDDER COVERS

For your Hobie Cat. Excellent quality. Fastex fasteners keep the rudder covers firmly in place, even when trailering. Protects your rudders from nicks and grime. Sold in Pairs. Style and color may vary.

82420000 ALL BUT 21SE

## SNORKEL JIB COVER

Protect your roller-furled jib from attack by ultraviolet light and the weather. Easy to install and remove—the Snorkel is a must for protecting your expensive sail from eventual destruction by the elements. The Snorkel is a zip-on cover for roller-furled jibs. Made from durable fabric with a full length zipper. Snorkel covers are not intended for long term storage. Jibs must be furled tightly, have luff tension and be secure for windy conditions. Loose jibs and cover may cause chafing damage to sail.

1811 H18/H16/Sport/21S

1812 H14 TURBO/H1-14

1813 H20/H21SE/H18SX

1815 GETAWAY



## TECH TIP!

**Covers:** Protect sails and hardware from sun and abrasion damage. Perhaps the greatest enemy of many modern fabrics is the sun's ultra violet radiation. It deteriorates nylon unless it's specially treated and it attacks dacron sail cloth and weakens it. Fortunately, nylon can be treated to make it UV tolerant and acrylic fabrics exhibit seemingly endless resistance to UV radiation. These sail bags and sail covers can be used to protect your dacron sails from UV radiation damage.

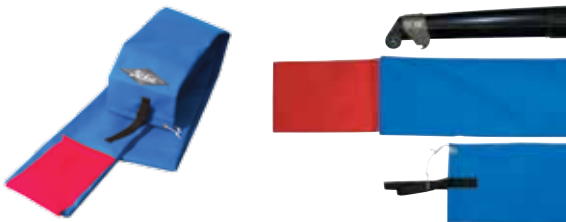

## COMPTIP COVER

Hobie Cat recommends that the Comptip portion of the mast be covered to protect it from ultraviolet rays. Our cover is made of UV resistance treated nylon. Ties on to the mast with line that is provided. Fits all Hobie Cats. Will not work with mast floats installed. Royal blue.

3125 COVER- H16/18/20

3127 COVER-H17/21

# STICKERS



- 13001001 HOBIE "FLYING H" BLACK 12 5/8"
- 36601000 HOBIE "FLYING H" BLACK 6"
- 36601011 HOBIE "FLYING H" WHITE 6"



- 12451050 "SCRIPT" BLACK 24"
- 12451051 "SCRIPT" WHITE 24"



- 12453031 HOBIE "TEQ SUNRISE" DOME 4 1/2"



- 79545001 HOBIE "H" DOME 2 1/4"



- 12453023 HOBIE CHROME BLACK



- 12453026 HOBIE SAILING ASSORTED COLORS



## SAILORS' ALL PURPOSE TOOL

Handles screws, bolts, and shackles. Wide blade fits up into Hobie Cat's lower rudder castings for adjusting cam spring tension. Narrow blade fits the rudder stop screw and its built in hook is designed specifically to return locked "down" rudder cams to the "up" position with the twist of the wrist.

83103 EACH

**EASY RIG** Great little temporary handle for halyards, outhauls, downhauls and trampoline tightening. Lay the line in the slot and pull. The line seats in the easy rig handle and provides a handle for tensioning the system. Also available in aluminum from Clamcleat as "Tug Cleat"

2065 UP TO 3/16" LINE

2069 1/4" to 1/2"

2070 TUG CLEAT 1/8"-1/4"



2070

2069

2065



## WIRE CUTTER

Do it yourself. Precision designed triangular jaws close and cut. No uneven ends.

83105 EACH

## STAINLESS STEEL POCKET KNIFE

DELUXE - Marlin spike, knife blade, shackle tool, and screwdriver. 4.0 oz.

1551 DELUXE



## GERBER NEEDLENOSE MULTI-PLIER®

Since 1939 Gerber has produced high quality innovative products for the outdoors. Features included in this model are; needlenose pliers, wire cutter, crimper, standard/ metric scale, lanyard ring, cross head screwdriver, bottle/ can opener, serrated sheeps foot blade, large, medium, and small flathead screwdrivers, file, drop point blade, and it adapts to the Gerber Tool Kit! This Multi-Plier® comes with the S.A.F.T. PLUS™ System where each component opens independently of all others, locks tightly against a positive stop roll bar and stays tight until you unlock it. Stainless steel construction with a limited lifetime warranty!

83102 GERBER TOOL

## SWAGE-IT TOOL

Make your own wires for those special gadgets you like. Swaging pressure is applied with a box or socket wrench. For 1/16", 3/32", and 1/8" wire sleeves.

83106 EACH



## HOG RING PLIERS

Cinch rings, hog rings, upholsterers clamp. They are all the same and these are the pliers to crimp them with. Use them on shockcord.

83104 EACH





**HOBIE MULTI-LUBE** is a planet-safe lubricant recommended for lubricating in-the-water applications. Hobie Multi-Lube offers excellent lubrication, is an anti corrosive coating, great for cleaning and many other uses... use on nearly anything that squeaks, rusts, corrodes or binds up; MirageDrives, rudder drums, cams, fishing reels and more.



The 1 oz size is perfect for getting the lubricant into tight spaces by using the needle applicator. The 4 oz size has a spray applicator for coating chains and larger surfaces, shafts and bulky parts.

**5120** MULTI LUBE 1 OZ  
**5121** MULTI LUBE 4 OZ

**SILICONE SPRAY**

Dry silicone spray for cleats, hatch O-rings.

(Image above may not represent current packaging or volume)

**5107** SILICONE 7oz.



**TEAR-AID**

Each TEAR-AID® repair patch is made from an exceptionally tough, matte finish, abrasion resistant, elastomer that resists puncture and tearing. It is combined with an aggressive adhesive formulated for high bond strength to a variety of surfaces such as canvas, leather, rubber,

nylon, most plastics, paints, aluminum,

stainless steel, fiberglass, polyurethane, polyethylene, polypropylene, vinyl and vinyl coated. TEAR-AID® Type A and TEAR-AID® Type B provide a simple and easy method of patching holes and tears, as well as an excellent protective film solution.

**72020030** TEAR-AID / TYPE A (POLY)

**72020031** TEAR-AID / TYPE B (VINYL)

**EACH PATCH KIT CONTAINS:** (1) 3" x 12" TEAR-AID® Patch that cuts with scissors to any size, (1) 7/8" x 7/8" Patch, (1) 1 3/8" x 1 3/8" Patch, (1) 12" Reinforcement Filament for repairing tears at edges, (2) Alcohol Prep Pads, (1) Illustrated Instructions and a Product Repair List.

**CLEAR SILICONE SEALER**

Make sure your hulls are watertight! Clear Silicone seals leaks around all thru-hull fittings such as gudgeons, drain plug housings, tangs, and pylons. Use when re-rievting mast, boom, and crossbar fittings.

**376** 1.5 oz. TUBE



**AQUASEAL MIRAZYME ODOR ELIMINATOR**

There's nothing quite like the odor of damp sailing gear left in your car trunk for a couple of days. With one application eliminate those odors from booties, wet-suits, dry-suits and the rest of your gear. A 100% biodegradable product made from a blend of 10 highly specialized, light activated microbial elements. Works by penetrating into pores of fabric, rubber and even hard surfaces to eliminatem odor naturally.

**7003** 8oz.



**HOBIE BOAT CLEANER**

Formulated with "Green Chemistry" to safely remove dirt and stains from Hobie products. Good on fiberglass, polyethylene, Vinyl (trampolines) and PVC (inflatable). Cleans the most stubborn stains off of hulls. 12 oz.

**70050001** HOBIE BOAT CLEANER

**HOBIE UV PROTECTANT**

Protect and rejuvenate fiberglass, polyethylene, vinyl and PVC materials.

Wipe on, the protectant absorbs into the material and leaves a UV protective layer. Reduce the loss of essential oils and deflect the sun's harmful UV rays. 12 oz.

**70060001** HOBIE UV PROTECTANT



**STARBRITE FIBERGLASS COLOR RESTORER**

Brings back original color and luster. Removes heavy oxidation, chalking and fading. Protects against future fading. Will not scratch gelcoat. Excellent for all dark colored boats. No hard rubbing is necessary.

**1618** 16 oz. BOTTLE



**STARBRITE POLISH**

During the many months of storage, wind can force dirt into the microscopic pores of your hull and leave the surfaces dull and gritty. To prevent this, an application of Starbrite Marine Polish will seal the hull of your boat and insure a bright and shiny surface when spring comes around.

Weather resistant protective coating will keep your hull dirt and stain free.

**1611** 16 oz. BOTTLE



**SEA SPRAY TRAMP CLEANER**

We've formulated our own trampoline cleaner. It comes in a pump spray bottle so you can apply a light spray to the trampoline, brush and rinse off. It removes dirt, stains, and mildew. Cleans new trampolines and restores old ones.

**1619** TRAMP CLEANER



**MAGICA RUST REMOVER**

Easily clean rust stains from fiberglass, plastic surfaces, metal parts or fabrics. Although metal parts are made from high quality stainless steel, machining tools often leave carbon particles imbedded in the metal surfaces. This material can bleed a rust stain onto other surfaces. Magica simply dissolves the rust away.

**1603** MAGICA GEL 8 oz. BOTTLE



**FSR** Fiberglass Stain Remover, is a unique stain absorbing gel. Ideal for removing oil, rust, exhaust, waterline, and transom stains yet it can also be used anywhere else fiberglass stains may crop up - shower stalls, furniture, etc. Removes road soil. Non-abrasive. Requires no sanding or compounding. Simply apply with a brush, sponge, or cloth, wait a few minutes, then wipe off.

**790** ONE PINT



## RONSTAN CLEARSTART WATCH

### Race Mode Features - Watches & Race Timer

Multiple Start Sequence options – ISAF 5,4,1,0, Match Racing, User Set  
 SYNChronisation function – auto-correction if you start the countdown early or late  
 Multi-line display – Start Sequences + Time  
 Loud intuitive lead-up and start sound signals  
 Countdown repeat or Count down and up options (for elapsed race time).  
 Separate fast access Race and Time mode scrolling.  
 Water resistant to 5 ATM (50m/150ft) – double gasket seals

### Standard Features - Watches & Race Timer

Time, hours/minutes/seconds – 12 or 24hr format  
 Month/Day or Day/Month format  
 Daily alarm  
 Chronograph - Including hours and time of the day  
 Luminescent backlight.  
 Battery saving mode – light can be turned off  
 Shock resistant

RF4052A SAILING WATCH

RF4050 RACE TIMER



## SHROUD ADJUSTER COVERS

Protect hands and feet by covering up sharp edges with these soft vinyl molded adjuster covers. Also great for keeping clevis pin rings from getting snagged and working out of the pin.  
 Sold in pairs.

3261B BLACK, 12"

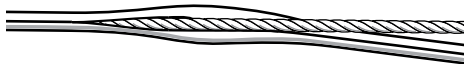

## WIRE COVERS

Standard wires come with molded covers. If your wires are bare you can cover up with these durable vinyl covers for shroud, trapeze wires, stays, etc. Comes in 6 foot lengths. The H16 and H17 shrouds and forestays are 1/8". The H18 shrouds and forestays are 5/32". Many customers prefer to order the next size larger. They will fit just as well and are easier to install.

3252W 1/8" WHITE

3253W 5/32" WHITE

## HOBIE STANDARD MAST BEARING

Package of 3 for the 14 & 16.

11110005 3 BEARINGS



## H18 MAST BEARING KIT

For H18. Eliminate that screech when your mast rotates. Get a new bearing with a Teflon™ disk to fit under the bearing.

1132 BEARING & DISK



## ROOF RACK PADS

Beefy car roofrack pads, made from durable black polyester with Hobie diamond logo. Easy-on split bottom with Velcro™ closure.

72045 24" ROOF RACK PAD (PAIR)

72046 36" ROOF RACK PAD (PAIR)



RF4052A

50mm (2") diameter face  
 Oversized 13mm (1/2") digit display



RF4050

65mm (2 9/16") diameter face  
 Oversized 16mm (5/8") digit display



## CHEATA MOTOR MOUNT

Maneuver your boat in channels, streams or up wind to your favorite beach. Move around with or without the wind. Easy to install motor bracket attaches to the rear cross bar.

3180 WAVE CLUB / H14 / 16 / 17

3184 GETAWAY



## MOTOR MOUNT WAVE SE

Maneuver the Wave in channels, streams or up wind to your favorite beach. Move around with or without the wind. Our easy to install electric motor bracket attaches to the rear cross bar with the trampoline strap. Pre-EZ LOC rudders only

3183 MOTOR MOUNT

## STAINLESS WATER BOTTLE

71995001 20oz



## HOBIE KEY FLOAT

Don't lose those keys! Keep a few bucks dry, inside the small compartment, while you sail.

72010 EACH

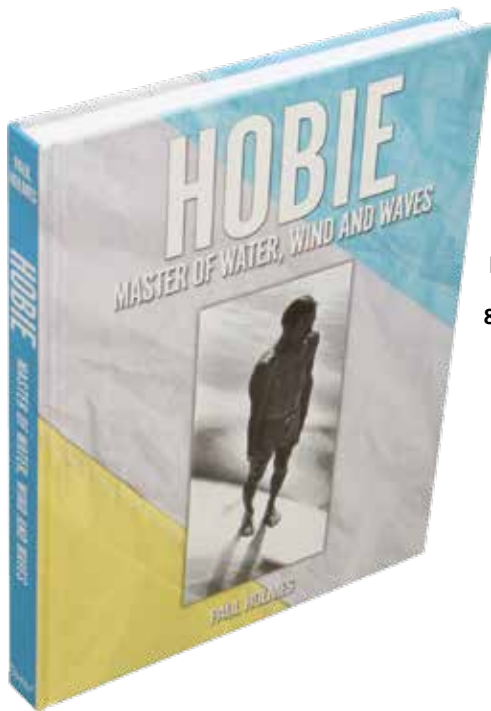

**HOBIE-MASTER OF WATER, WIND, AND WAVES**

The man, Hobie, known by just one name worldwide, has an epic life story. This 12" x 9" hard-cover book shows how it all came to be, and more, in 17 chapters with 300 pages, 120,000 words of text and 585 photographs and illustrations. The book is available through Hobie Cat and Hobie Kayak dealers worldwide.

Surfboards, catamarans and boats, RC model airplanes (the Hobie Hawk), and a whole lot more "toys"—as Hobie himself describes his amazing life's work—will all be celebrated in the biography of the man who defined a lifestyle in surfing and sailing.

**87369116** BOOK, HOBIE-MASTER OF WATER, WIND, AND WAVES

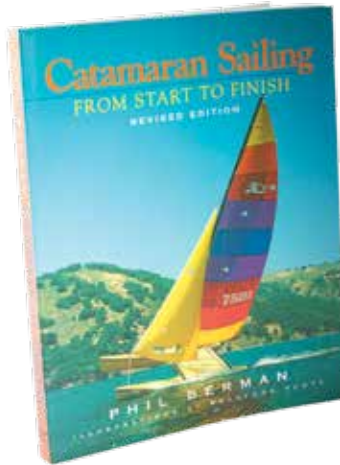

**BOOK - CAT SAILING**

By Phil Berman.  
This book covers rigging, heavy weather sailing, tuning, racing, surfing, maintenance, and trailering.

**610** CAT SAILING



**LICENSE FRAMES**

- 3041** "FLY A HOBIE CAT"
- 3042** "I'D RATHER BE SAILING"
- 3043** "HOBIE" CHROME



**DVD**

**SHARING THE WIND & A MOMENT'S GLORY**

Sharing the Wind was shot in California and Hawaii. It includes fantastic shots of a Hobie 18 totally airborne flying off the crest of a wave, sailing across a sand bar, triple trapezing, and daggerboard skiing. A Moment's Glory is the 1976 Hobie 16 Worlds in Hawaii off of Diamond Head. (NTSC DVD format)

- 84430202** DVD Sharing/Moments
- 84430203** DVD Hobie Film Festival



**DVD - CATAMARAN SAILING, A STEP BY STEP GUIDE**

This video will introduce you to the thrilling sport of sailing light weight catamarans (Hobie 16 and 18 are featured). Taught in an easy to understand manner, this program provides a boat load of information for beginners as well as seasoned sailors. 45 minute NTSC DVD format.

**84430401** DVD



**HOBIE CROAKIES**

Keep your glasses in place! Made from wetsuit fabric that will not stretch or lose shape when wet. Remains secure whether worn normally, raised or lowered around your neck.

**1553CR** EACH

Tricia  
Executive Assistant

Kim  
Administrative  
Assistant

Howie  
Fishing Parts  
Coordinator



6513X  
Zip Hoodie  
California Logo,  
Charcoal

6515X  
Zip Hoodie  
California Logo,  
Oatmeal

6514X  
Zip Hoodie  
California Logo,  
Burnt Orange

# Hobie Hoodies, Hats, Tees, & Towels For Your Outdoor Lifestyle



6508X  
Men's L/S T-Shirt  
Hobie® Script Logo

6512X  
Unisex Pullover Hoodie Script  
Logo





**6501X**  
Men's Black T-Shirt Hobie  
California Logo



**6502X**  
Men's Cream T-Shirt Hobie  
California Logo



**6503X**  
Men's White T-Shirt Classic Surf  
Logo



**6504X**  
Men's White T-Shirt Classic  
Diamond Logo



**6505X**  
Men's Black T-Shirt  
Classic Surf Logo



**6506X**  
Men's Black T-Shirt  
Classic Diamond Logo



**6507X**  
Men's Grey L/S T-Shirt  
Hobie Script Logo



**6508X**  
Men's Charcoal L/S T-Shirt  
Hobie Script Logo



**6509X**  
Unisex Charcoal Pullover Hoodie  
Script Logo



**6511X**  
Unisex Oatmeal Pullover Hoodie  
Script Logo



**6512X**  
Unisex Burnt Orange Pullover  
Hoodie Script Logo



**6513X**  
Unisex Charcoal Zip Hoodie  
California Logo



**6514X**  
Unisex Burnt Orange Zip Hoodie  
California Logo



**6515X**  
Unisex Oatmeal Zip Hoodie  
California Logo



**6517X**  
Ladies Lt Grey L/S Scoop Neck  
with Flying H



**6518X**  
Ladies Charcoal L/S Scoop Neck  
with Flying H

**X=Size Key:** 1=S, 2=M, 3=L, 4=XL, 5=XXL, 6=XXXL (Example, 65011 is the Men's Black T-Shirt S/S with Hobie California Logo in size small.)

# Fish. Kayak. Surf. Sail. Stand Up. Sun.

- 6000  
Beach Towel,  
Orange
- 6001  
Beach Towel,  
Lime
- 6002  
Beach Towel,  
Yellow
- 6003  
Beach Towel,  
Aqua



**HOWEVER YOU HOBIE,  
WE HAVE YOU COVERED.**

**Beanie:** Fleece-lined, knit acrylic and warm wool takes the sting out of the end of summer.

**Cap:** Hats for all tastes and passions. Flat and curved bills; Snapback, Flexfit, or Velcro closures; hard or soft mesh backs.

**Lifeguard Hat:** Our classic straw styling is cool, lightweight and timeless.

**Visor:** For minimalists — all brim, nothing extra.

**5028LXL**  
Penguin,  
Flexfit



**5019BK**  
Low Profile  
H, Velcro



**5016BL**  
Visor,  
Velcro



**5037SM  
/5037LXL**  
Flying H,  
Flexfit



**5038SM  
/5038LXL**  
Flying H,  
Flexfit



**50270M**  
Hobie  
Fishing,  
Buckle



**5032**  
Hobie  
Kayak,  
Velcro



**5034**  
Have A  
Hobie  
Day, Snap



**5029**  
First Cast,  
Snap



**5030SM  
/5030LXL**  
Patch,  
Fitted



**5033SM  
/5033LXL**  
Patch,  
Fitted



**5039**  
Fish  
Pattern,  
Velcro



**5036**  
Flying  
Green H,  
Snap



**5031**  
Flying  
Side H,  
Snap



**5043**  
Eclipse,  
Velcro



**5044**  
Fish  
Pattern,  
Snap



**5045**  
Camo  
Redfish,  
Snap



**5046**  
Red  
Redfish,  
Snap



**5047**  
Bass,  
Snap



**5049**  
Dorado,  
Snap



**5050**  
Striper,  
Snap



**5054**  
Sailing,  
Snap



**5055**  
Angle H,  
Snap



**5018RM**  
H Mesh,  
Velcro



**5040**  
Classic  
Surf,  
Trucker



**5041**  
Classic  
Diamond,  
Trucker



**5042**  
Lifeguard,  
Straw



**1553**  
Lid Latch



**5026BM**  
Beanie,  
Black



**5026BW**  
Beanie,  
White



**5056**  
Fleece-  
lined  
Beanie,  
Black



**5057**  
Fleece-  
lined  
Beanie,  
Grey



## HOBIE CAT ILLUSTRATED PART GUIDES BRAVO, WAVE, GETAWAY, 14, 16, 17, 18

### TECHNICAL SUPPORT / ONLINE SUPPORT / FORUMS

Be sure to see the Hobie Sailor forums for online technical help. This includes an FAQ section and many ongoing technical and sailing topics.

### PARTS GUIDES AVAILABLE ONLINE

All Illustrated Parts Guides including Tiger, Wild Cat, Fox, H20, H21SE, Sport Cruiser, Trifoiler, Hobie One/Holder are available online in our support and parts sections.

[hobiecat.com/support](http://hobiecat.com/support)

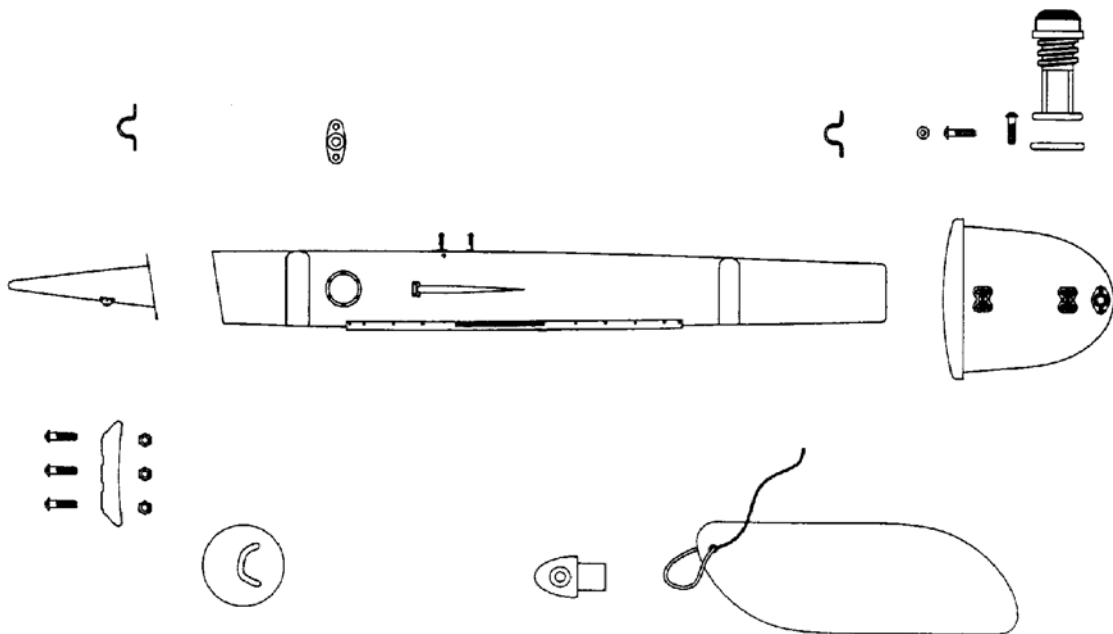

### HOBIE CAT PARTS - WARRANTY POLICY

**HOBIE PARTS WARRANTY** Hobie Cat warrants all Hobie Cat manufactured parts and accessories against failure due to materials or workmanship defects for a period of one year.

**OUTSIDE USA WARRANTY INFORMATION** - Regions Outside of the USA refer to warranty policy statement issued in each country.

**OTHER WARRANTY** Any accessories and other merchandise sold by Hobie Cat not mentioned in the paragraph above are not warranted by Hobie Cat. Said accessories and other merchandise may be covered by the manufacturer's warranty, a copy of which can be furnished by Hobie Cat upon written request.

**HOBIE CAT'S OBLIGATION** Hobie Cat at its option will repair or replace without charge any part or accessory which is found to be defective under the terms and within the period of this Warranty. Buyer must return the accessory with a sales slip as proof of purchase date.

**BUYER'S OBLIGATION** Upon discovery of a suspected defect, Buyer must-at his/her own expense-promptly return the equipment to the Hobie Kayak dealer for inspection. Warranty is void if equipment is

operated after a suspected defect is, or should have been, discovered.

**WHO IS ENTITLED TO WARRANTY** Only the original Buyer of the equipment and accessories from Hobie Cat is entitled to warranty. Warranty may not be transferred.

**NO WARRANTY OF USED EQUIPMENT** Used equipment is sold AS IS; Hobie Cat makes NO WARRANTY concerning its merchantability, condition, durability, age or model year, or fitness for any purpose whatsoever.

**MUTUAL AGREEMENTS** It is agreed that this warranty sets forth Buyer's exclusive right and remedy against Hobie Cat with respect to the equipment and accessories. It is in lieu of all other express warranties and all implied warranties, including implied warranties of merchantability and fitness. Hobie Cat assumes no other like or unlike liability for loss of cargo, use, profit or consequential damages of any kind in connection with the sale, alteration, use, repair or replacement of equipment or any part thereof.

# HOBIE BRAVO

REPLACEMENT HULL - 90010000

Handle '08 71190021  
Handle 71190011  
Screw 8030201 (2)

Decals -  
12450015 "Curtis" Set  
12450016 "Bravo" Each

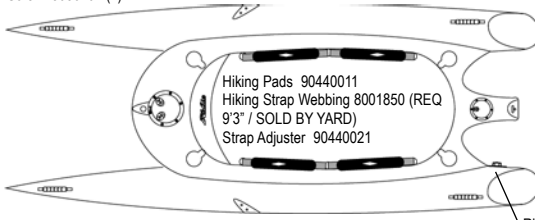

Drain Plug w/ gasket  
10091000 (2)  
EZ LOC Rudder Pintles  
Upper Pintle 90880211  
Lower Pintle 90880221  
Pintles: (For Aluminum  
Castings / Pre-March 2004)  
Upper Pintle 90880111  
Lower Pintle 38101401  
Long Loc Screw 8030411  
Righting Line RL012BLU 10' 9"  
Cheek Block H233  
Screws 8030071

Fwd Hatch 8" 71702011  
Fwd Hatch Gasket 71331001  
Screws 8031130

Rear Hatch 6" 71701011  
Rear Gasket 71320001  
Screw 8030261

## RUDDER ASSEMBLY - EZ LOC

90312000

Tiller Extension 90550011 Grip 3206  
Tiller Hinge 10532010  
Screw 8032061  
Nut 8050101  
Hinge Yoke 3205  
End Cap 90560041  
Screw 8031191  
Washer 8080561  
Mainsheet Bracket 90700201  
Screw 8030981  
Nut 8050211  
Upper Bolt 8040391  
Nut 8050331  
EZ LOC Housing 50313001  
Detent Plunger 20492021  
Retainer Clip 90880231  
Bungee (3/16" x 10") RS316BLK  
Lower Bolt 8040321  
Washer 8080671  
Nut 8050331

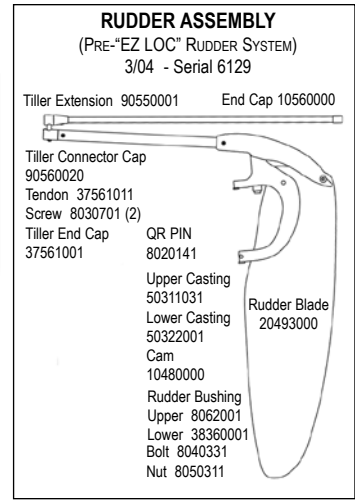

**RUDDER ASSEMBLY**  
(PRE-"EZ LOC" RUDDER SYSTEM)  
3/04 - Serial 6129  
Tiller Extension 90550001 End Cap 10560000  
Tiller Connector Cap 90560020  
Tendon 37561011  
Screw 8030701 (2)  
Tiller End Cap 37561001  
QR PIN 8020141  
Upper Casting 50311031  
Lower Casting 50322001  
Cam 10480000  
Rudder Bushing Upper 8062001  
Lower 38360001  
Bolt 8040331  
Nut 8050311

"A" Frame Vertical Support Assy  
Serial Numbers to 0701 90710011  
Serial Numbers 0702 - To current 90710000

A-frame Connector 90501031  
Screw 8030380 (Older)  
Screw 8030361 (Newer)  
Washer 8080481 (Newer)  
Furler Strap w/ Clip 90501036  
Washer 8080551  
Screw 8030181

A-Frame Support Base Cap  
90710010 (Newer 5/16-18)  
8031810 Stud 5/16-18

Bravo Mast Float w/Straps and Buckles  
90600012 UNIVERSAL



Nylon "Saddle" Strap 90600021 (2 Per)  
Screw 8030071 (4 Per)  
Attachment Web Strap  
W/ Buckle 90600041 (2 Per)

## MAST

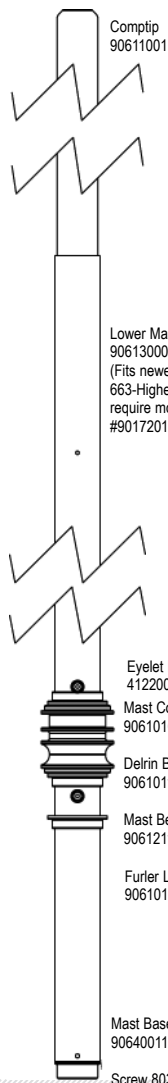

Comptip 90611001

Lower Mast 90613000  
(Fits newer boats serial  
663-Higher) Older boats  
require modified step assy  
#90172011

Eyelet Posts (2) 41220001  
Mast Collars (3) 90610101  
Delrin Balls (48) 90610111  
Mast Bearing 90612111  
Furler Line 90610121  
Mast Base 90640011  
Screw 8031151

## SAIL

Bravo Sail 9099XXXX  
Sail Bag 90992000  
Mast/Sail Bag 90991000

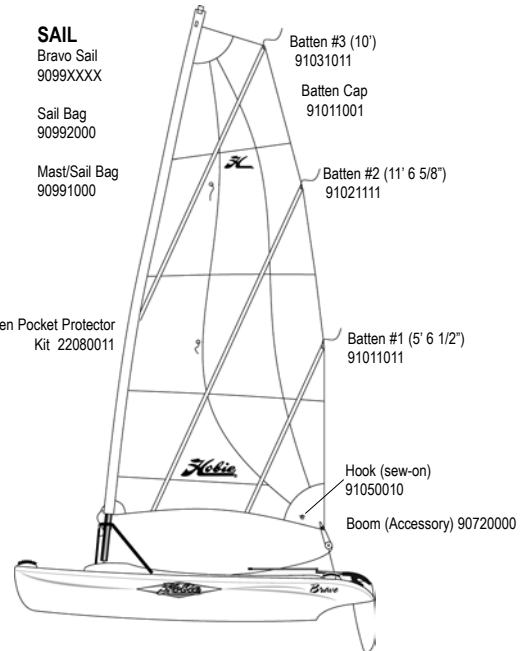

Batten #3 (10') 91031011  
Batten Cap 91011001

Batten #2 (11' 6 5/8") 91021111

Batten #1 (5' 6 1/2") 91011011

Hook (sew-on) 91050010

Boom (Accessory) 90720000

Luff Batten Pocket Protector Kit 22080011

## A-FRAME

2 Pc A-frame 90701001\*

Mast Keeper Knob 90502031  
Hinged Gate Knob 90502041  
Padeye 71220001  
Camcleat 37380001  
Hinge/Gate Assy Original Style 90500021  
Screw 8031130  
Newer Gate design is not designed as an upgrade  
Cover Plate 90700050  
Screw 8031130

\*A-Frame Attachment Kit  
Serial 0001-0501 Part #90711001  
Serial 0502-Current Part #90711011

## MAST STEP ASSY

Mast Step Assy 90170011 (Serial 663-NEWER)  
Mast Step Assy 90170001 (Serial 662-OLDER)

Screws 8032011  
Mast Ball 90640021

## BRAVO RIVET GUIDE

( ) Indicates quantity need to fasten part

### Mast

Comptip Notch 8010181(1)  
Collars 8010131 (4/collar)  
Eyelet Posts 8011231 (1/post)

### A-Frame

Gate Hinge 8012062 (1)  
Padeye 8010131 (2)  
Cam Cleat 8010131 (2)

### Vertical Support Tube

Base 8010181 (4)  
Webbing Strap 8010181 (2)  
A-frame Connector 8010131 (2)

### Rudder

Upper Casting 8010131 (3)  
Tiller End Cap 8010131 (2)  
Bravo Extension Cap 8010181 (1)

### Boom

End Cap 57130000(2)  
Boom Cap Casting 8010131 (2)  
Padeyes 8010131 (2/padeye)  
Cam Cleat 8010131 (2)

## RIGHTING LINE



Mainsheet Line RM516BLU (28 1/2')

Single Block 90440050

Righting Line RL012BLU (10' 9")

Bungee Cord RS014BLK (7')

Cheek Block H233

## Mainsheet System

Hook 38670011  
Block 90700121

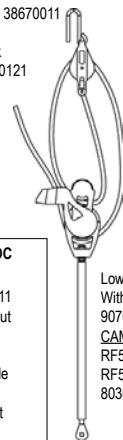

### Pre-EZ LOC

Nut 8050111  
Low Pro Nut 8050101

Older Cable Mainsheet attachment assembly 90700011

Lower Block With Post 90700131  
CAM CLEAT RF5011 CAM CLEAT RF5015 FAIRLEAD 8030241 SCREW (2)

# HOBIE CLUB WAVE PARTS

**WAVE VERSION NOTES:**

**CLUB WAVE** - THREE PIECE TRAMPOLINE. SHROUDS AND BRIDLES CONNECT WITH CLEVIS PINS.

**CLASSIC WAVE** - ONE PIECE TRAMPOLINE. SHROUDS AND BRIDLES CONNECT TO HULL WITH HOOKS.

BRIDLE  
EYESTRAP  
38120011

SCREW  
8030331

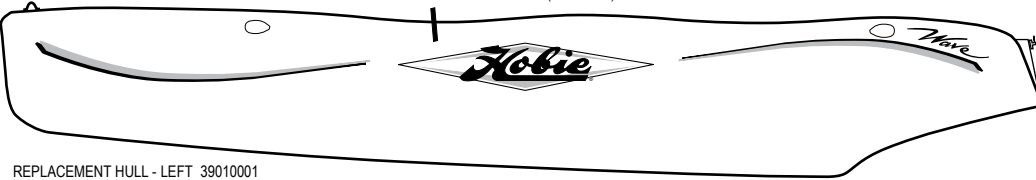

REPLACEMENT HULL - LEFT 39010001  
REPLACEMENT HULL - RIGHT 39020001

ANCHOR PLATE 39100011 (PAIR)  
SCREW 8030331  
PUSH-IN PANEL RIVET (INBOARD) 38120031

DECALS -  
12450015 "CURLS" COMPLETE SET  
12450017 "WAVE" EACH  
12451031 "HOBIE" DIAMOND 36" TURQUOISE EACH

EZ LOC RUDDER PINTLES  
UPPER PINTLE 90880211  
LOWER PINTLE 90880221

SCREW 8030171  
SCREW (2009+) 8030331



DRAIN PLUG  
W/ GASKET 10091000

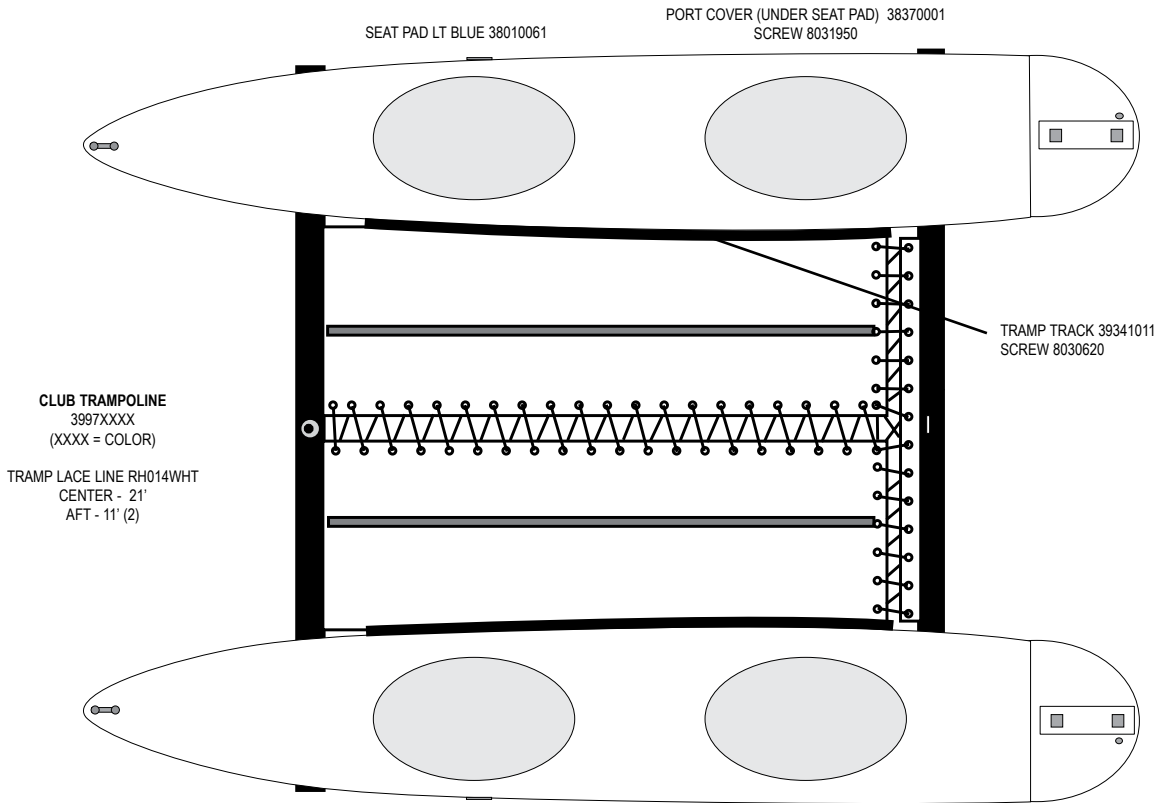
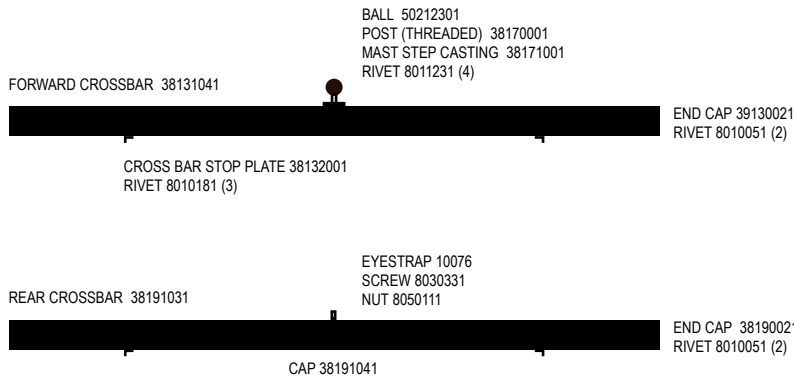

TILLER CROSSBAR - EZ LOC 39524001 (67" TUBE)

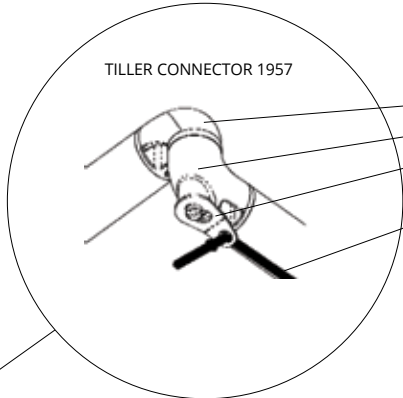

TILLER CONNECTOR 1957

- END CAP - WITH PIN 37561203
- END CAP - THROUGH HOLE 37561200
- TILLER CONNECTOR RETAINER 40590001
- SHOCK CORD (10") RS316BLK
- SCREW 8031151
- RIVET 8010261

EZ LOC RUDDER ASSEMBLY  
39312000

TILLER ARM  
39382011

RETAINER CLIP EZ LOC RDR HOUSING 90880231  
BUNGEE (3/16" X 10") RS316BLK

EZ LOC HOUSING 50313001  
LOWER BOLT 8040321  
WASHER 8080671  
NUT 8050331  
EZ LOC PLUNGER 20492021

UPPER BOLT 8040391  
NUT 8050331

RUDDER LINKAGE (2)  
50313201  
TUBE RIVET  
50313301

UP-LOCK PIN KIT  
50314001  
(PIN, LANYARD 37661091,  
2-RING 20860000)

EZ LOC  
RUDDER  
BLADE  
20491000

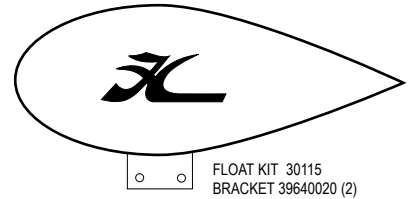

FLOAT KIT 30115  
BRACKET 39640020 (2)  
SCREW 8032011 (4)

MAST HEAD ASSY 10602111  
RIVET 8010131 (2)  
SHEAVE 20614210 (2)  
SPACER 20614231 (2)  
CLEVIS PIN 8020340 (2)  
LOCK RING 10860001 (2)

MAST ASSEMBLY 38581041  
COMPTIP 38582100  
LOWER MAST 38583141

HALYARD HOOK 10680000  
RIVET 8010181 (2)  
CAP 8011291 (2)

LUFF TRACK  
38584001

HALYARD  
38651001

MAST TANG 10690000  
RIVET 8010181 (6)  
CAP 8011291 (6)

FOAM PLUG  
10060000

DANGER LABEL / WATCH FOR  
WIRES 13440010

MAST CAUTION LABEL 13440000

HALYARD CLEAT 10730000  
RIVET 8010121 (2)  
RIVET CAP 8011291 (2)

DOWNHAUL CLEAT 10730000  
SCREW 8030111 (2)  
NUT 8051301 (2)

MAST STEP PIN 8020451

MAST BASE 38641001  
RIVET 8010131 (3)  
RIVET CAP 8011291 (3)

**UPDATE OLDER WAVE  
TO EZ LOC**

- (2) **39312000** EZ LOC RUDDER ASSEMBLY
- (1) **39524001** TILLER CROSSBAR
- (2) **90880211** PINTLE - UPPER
- (2) **90880221** PINTLE - LOWER
- (12) **8030171** SCREW 12-24 X 3/4

**DANGER:**

ALWAYS USE EXTREME CAUTION WHILE  
RAISING AND LOWERING YOUR MAST, CONTACT  
WITH A POWER LINE COULD BE FATAL.

FORESTAY / BRIDLES

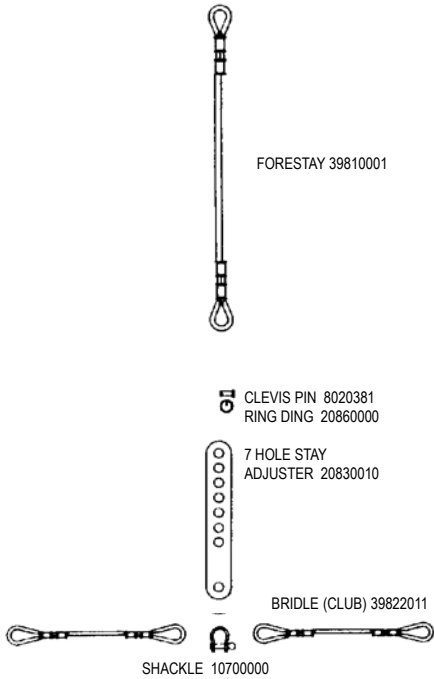

SHROUDS

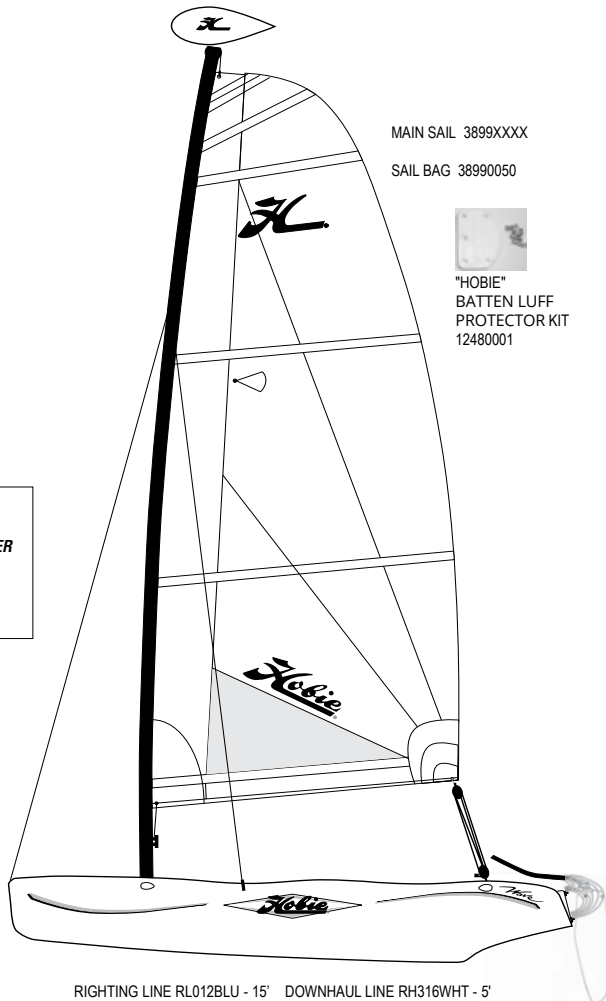
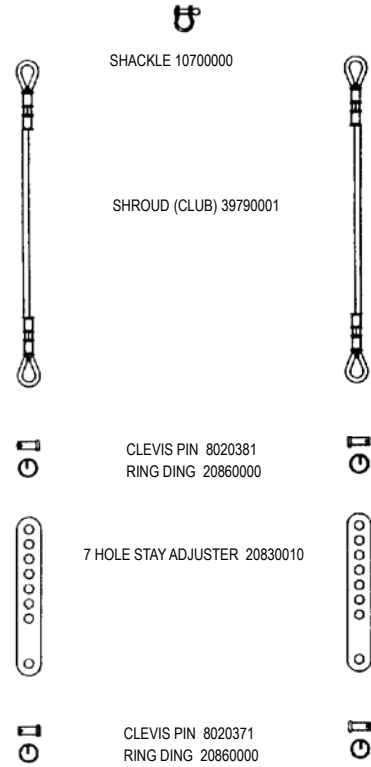

**MAST**  
**SERIAL NUMBER 1438 AND NEWER**  
MAST ASSEMBLY 38581041  
LOWER MAST 38583141  
MAST BASE (CUP) 38641001

- (H16 JIB) BATTEN #5 36"
  - (H16 JIB) BATTEN #4 50"
  - BATTEN #3 66 7/8"
  - BATTEN #2 77 7/8"
  - BATTEN #1 82 3/8"
- 38016001 HOBIE WAVE BATTEN SET  
(FOR INDIVIDUAL BATTENS SEE UNIVERSAL BATTENS IN CATALOG)

- LEECH BATTEN TIP (TOP TWO) 21333000
- LEECH BATTEN TIP 11323000
- LUFF BATTEN TIP 11322011
- BATTEN TIE LINE  
RH112WHT X 18"

"S" HOOK 38900031  
SHACKLE 11220000

UPPER BLOCK  
38900061

MAINSHEET  
RM516BLU X 35'

LOWER  
BLOCK 38900071  
CAM CLEAT  
RF5001 CAM CLEAT  
RF5005 FAIRLEAD  
8031011 SCREW (2)

MODEL / YEAR / ACCESSORY VARIATIONS

CLASSIC WAVE

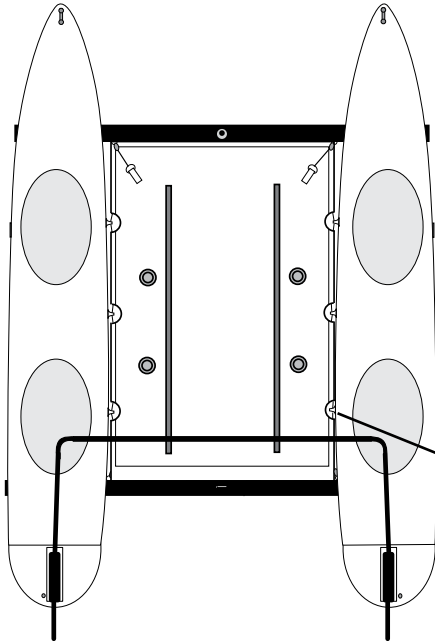

WAVE CLASSIC WIRES  
 SHROUD CLASSIC W/HOOKS 38790001  
 FORESTAY 39810001  
 BRIDLE CLASSIC W/HOOKS 38822011

OLDER -  
 TRAMPOLINE ANCHOR HOOK 38760031  
 NEWER-  
 (BOATS WITH TRACKS)  
 TRAMP TENSION SLIDE 38760071  
 STOPPER / FOAM 8003255 12 PCS X 2" (FT)

TILLER CROSS BARS

39521001 CLUB BOLT (62")  
 39522001 TENDON (62")

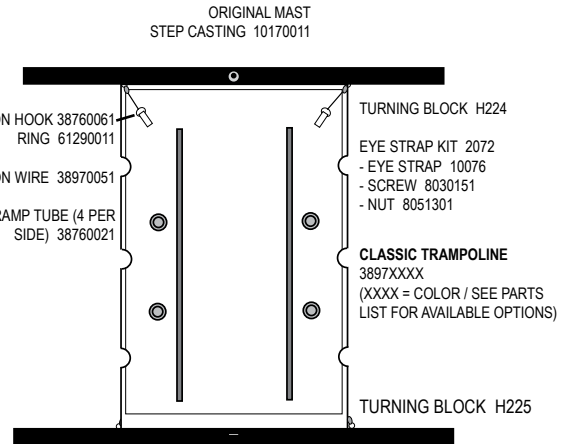

ORIGINAL MAST  
 STEP CASTING 10170011

SE LACE ROD 49" 38881011  
 SE VELCRO LACE STRAP  
 (4 PER BOAT) 38970061

RUDDER ASSEMBLY

Pre-"EZ LOC" Rudder System

\* = SUB ASSEMBLY PART / INCLUDED WITH CASTING

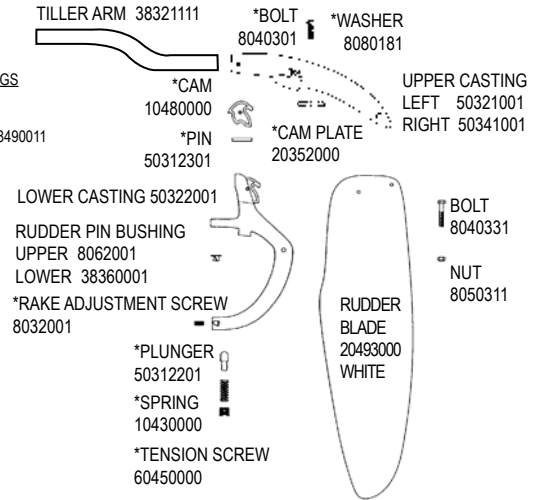

OLDER TILLER CONNECTOR PARTS

CLUB TILLER CONNECTOR (1954 / 1956)

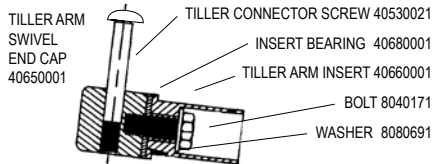

1956 KIT - CLUB TILLER CONNECTOR  
 (REPLACES TENDON STYLE WITH CLUB BOLT STYLE)

1954 KIT - CLUB TILLER CONNECTOR / UPGRADE FOR EARLY BOATS  
 WITH ORIGINAL CURVED TENDON CONNECTORS.  
 INCLUDES TILLER CROSS BAR AND ALL TILLER CONNECTOR FITTINGS

TENDON TILLER CONNECTOR

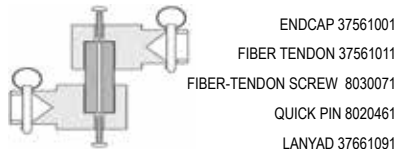

ALUMINUM RUDDER CASTINGS

UPPER PINTLE 38101301  
 LOWER PINTLE 38101401  
 KEEPER PIN W/ LANYARD 38490011

MAST

SERIAL NUMBER 0 THROUGH 1437  
 OLD MAST ASSEMBLY NLA (SEE  
 NEW STYLE REQUIRES MAST STEP  
 RETROFIT.  
 MAST BASE (HOBIE14 STYLE)  
 10640011

COMMON ACCESSORIES

BOW SPREADER 38999021  
 END CAP 38950011  
 BOW SPREADER TANG 38120041  
 SEAT BACKREST KIT 38040011  
 BACKREST INSTALLATION QUICK PIN 8020181  
 BACKREST PLUG, FORWARD 38660011  
 BACKREST PLUG, AFT 38660031

Wave Rivet Guide ( ) Quantity needed to fasten part

<b>MAST</b>		<b>REAR CROSSBAR</b>	
HEAD	8010131 (2)	PAD EYE	8010181 (2)
HALYARD HOOK	8010181 (2)	<b>FRONT CROSSBAR</b>	
	8011291 (2)	MAST STEP	8011231 (4)
TANG	8010181 (6)	<b>RUDDER ASSEMBLY</b>	
	8011291 (6)	UPPER CASTING	8010131 (2)
HALYARD CLEAT	8010121 (2)	(UNDERSIDE)	8011231 (1)
BASE	8010131 (3)	TILLER END CAP	8010131 (2)

MAIN TRAVELER KIT (CLUB) 39250000

HIKING STICK KIT (EZ LOC) 39550001

# HOBBIE GETAWAY PARTS

REPLACEMENT HULL - left 37010001  
 REPLACEMENT HULL - right 37020001

EZ LOC RUDDER PINTLES  
 UPPER PINTLE 90880211  
 LOWER PINTLE 90880221

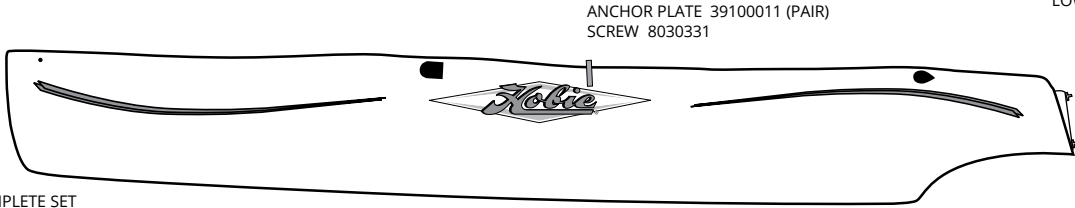

ANCHOR PLATE 39100011 (PAIR)  
 SCREW 8030331

SCREW 8030171  
 SCREW (2009+) 8030331

DRAIN PLUG  
 W / GASKET  
 10091000

DECALS -  
 37440150 "CURLS" COMPLETE SET  
 37440151 "GETAWAY" EACH  
 12451031 "Hobie" Diamond 36" Turq/Silver

BOW SPREADER 37500001  
 (37501701 2017+)

END BLOCK 37500031  
 RIVET 8010201 (4)  
 BOLT 8030291  
 WASHER 8080671

BOW TANG 20120000  
 BOLT 8040341  
 NUT 8050311  
 PLATE 37500021  
 RIVET 8010181

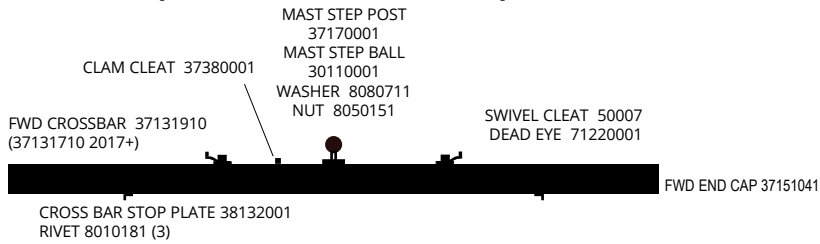

CLAM CLEAT 37380001  
 FWD CROSSBAR 37131910  
 (37131710 2017+)

MAST STEP POST  
 37170001  
 MAST STEP BALL  
 30110001  
 WASHER 8080711  
 NUT 8050151

SWIVEL CLEAT 50007  
 DEAD EYE 71220001

CROSS BAR STOP PLATE 38132001  
 RIVET 8010181 (3)

FWD END CAP 37151041

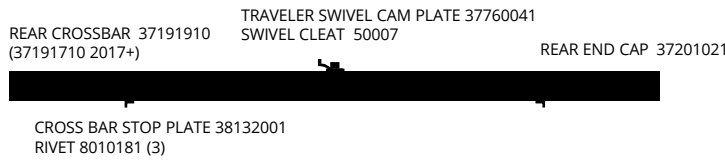

REAR CROSSBAR 37191910  
 (37191710 2017+)

TRAVELER SWIVEL CAM PLATE 37760041  
 SWIVEL CLEAT 50007

REAR END CAP 37201021

CROSS BAR STOP PLATE 38132001  
 RIVET 8010181 (3)

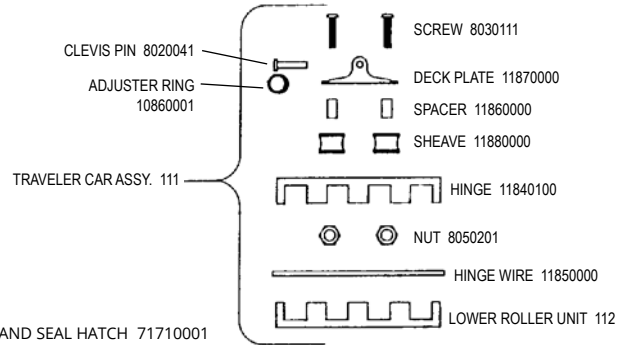

CLEVIS PIN 8020041  
 ADJUSTER RING  
 10860001

SCREW 8030111

DECK PLATE 11870000  
 SPACER 11860000  
 SHEAVE 11880000

HINGE 11840100

NUT 8050201

HINGE WIRE 11850000

LOWER ROLLER UNIT 112

ORIGINAL HATCH\*  
 \* Replacement "O" Ring Seal  
 # SPA-4SEAL-S Available from imtra.com  
 Not stocked by Hobie Cat

HOBBIE TWIST AND SEAL HATCH 71710001  
 GASKET 71707002 (REQ 2)  
 SCREWS 8032121 (REQ 14)  
 5" HATCH (INSIDE) 41370001  
 DRAIN ELBOW FITTING 37370036

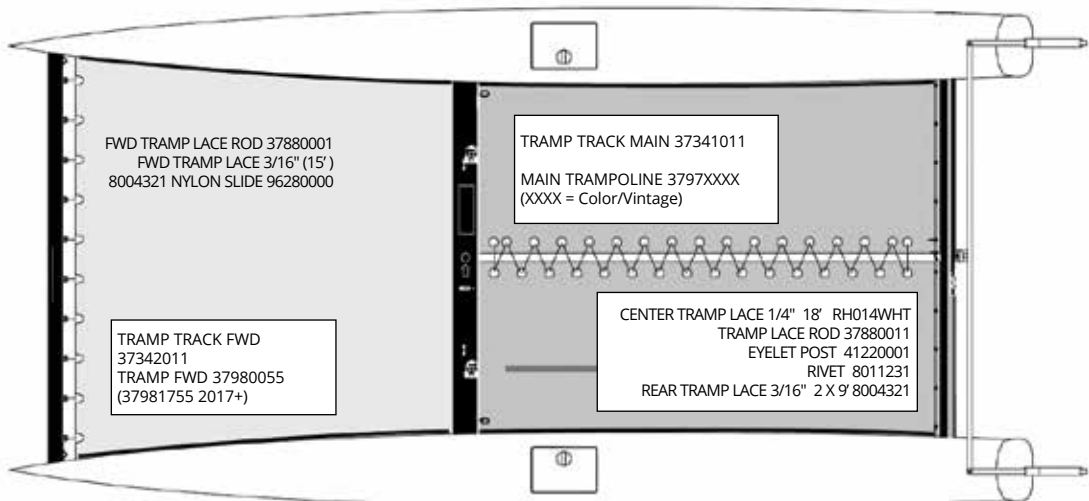

FWD TRAMP LACE ROD 37880001  
 FWD TRAMP LACE 3/16" (15')  
 8004321 NYLON SLIDE 96280000

TRAMP TRACK FWD  
 37342011  
 TRAMP FWD 37980055  
 (37981755 2017+)

TRAMP TRACK MAIN 37341011  
 MAIN TRAMPOLINE 3797XXXX  
 (XXXX = Color/Vintage)

CENTER TRAMP LACE 1/4" 18' RH014WHT  
 TRAMP LACE ROD 37880011  
 EYELET POST 41220001  
 RIVET 8011231  
 REAR TRAMP LACE 3/16" 2 X 9' 8004321

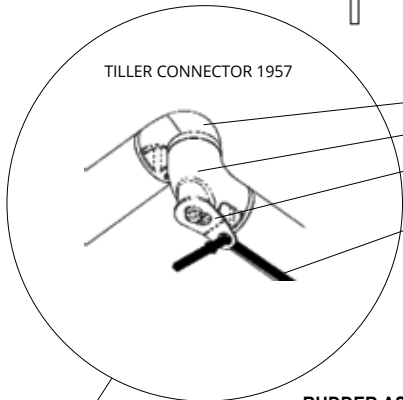
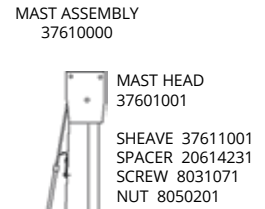
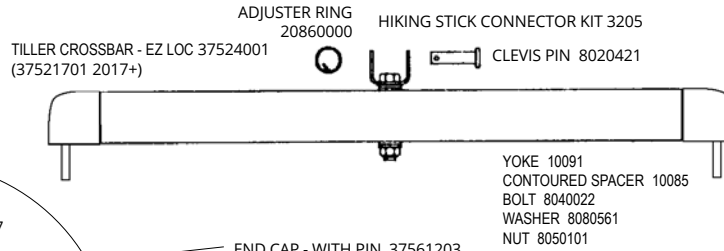
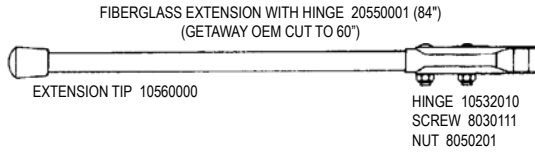

- END CAP - WITH PIN 37561203
- END CAP - THROUGH HOLE 37561200
- TILLER CONNECTOR RETAINER 40590001
- SHOCK CORD (10") RS316BLK
- SCREW 8031151
- RIVET 8010261

**RUDDER ASSEMBLY - EZ LOC**  
37312000

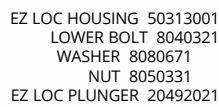
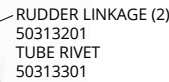
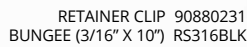
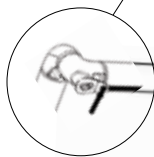
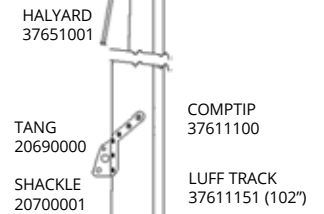

DANGER LABEL / WATCH FOR WIRES 13440010



DANGER LABEL / WATCH FOR WIRES 13440000

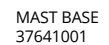
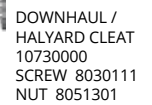
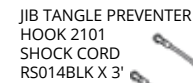

**UPDATE OLDER GETAWAY TO EZ LOC**

- (2) **37312000** EZ LOC RUDDER ASSEMBLY
- (1) **37524001** TILLER CROSSBAR
- (1) **20550001** HIKING STICK
- (2) **90880211** PINTLE - UPPER
- (2) **90880221** PINTLE - LOWER
- (12) **8030171** SCREW 12-24 X 3/4

**DANGER:**  
ALWAYS USE EXTREME CAUTION WHILE RAISING AND LOWERING YOUR MAST, CONTACT WITH A POWER LINE COULD BE FATAL.

FORESTAY / BRIDLES



FORESTAY ASSY 37810001  
 FORESTAY ASSY INCLUDES:  
 \*SHACKLE W/KEEPER WIRE 20700001  
 \*SWIVEL 61230000  
 \*YOKE 37810030  
 \*SCREW HSPAP  
 \*LOCK NUT 8050111  
 \*LOWER FORESTAY 37810021

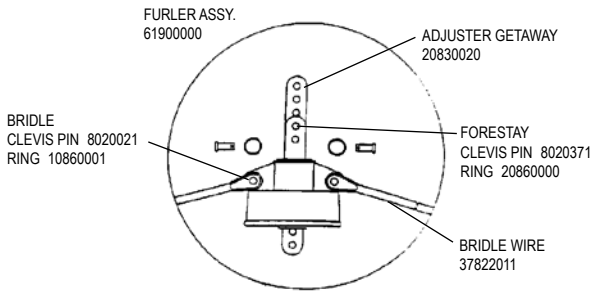

ROLLER FURLER DETAIL

**FURLER TUNE UP KIT 61900900**  
 INCLUDES: BEARINGS, BEARING CAGE, NYLINER, NYLON SLEEVE, DARBY RINGS, SPOOL, HOUSING

- CLEVIS PIN 8020371 RING 20860000
- SHACKLE 10700000
- ADJUSTER 20830020 FLATTENED
- NYLINER 8061101
- NYLON SLEEVE 61940000
- YOKE 61980000
- SPOOL & HOUSING SEE BELOW
- SLEEVE 61950001
- DARBY RING 8062511
- BEARING RACE 61920000
- \*\*\*\*\* BEARINGS (REQUIRES 18) 61670000
- BEARING CAGE 61930000
- BEARING RACE 61920000
- DARBY RING 8062501
- TUBE 61910000
- SPOOL & HOUSING 61960001
- NOT SHOWN
- LINE RH018WHT X 18' SCREW 8030501

FURLER ASSY. 61900000

SHROUDS



SHACKLE 20700001



SHROUD 37790001



CLEVIS PIN 8020381 RING DING 20860000

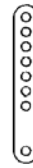

7 HOLE STAY ADJUSTER 20830010



CLEVIS PIN 8020371 RING DING 20860000



LEECH BATTEN TIP (TOP) 21333000



LEECH BATTEN TIP 11323000



LUFF BATTEN TIP 11322011



BATTEN TIE LINE RH112WHT X 18"

- BATTEN #8 34 1/2" (H16 JIB)
- BATTEN #7 55"
- BATTEN #6 69"
- BATTEN #5 77 3/4"
- BATTEN #4 84 1/4"
- BATTEN #3 88 3/4"
- BATTEN #2 90 3/4"
- BATTEN #1 92"

37016001 BATTEN SET (FOR INDIVIDUAL BATTENS SEE UNIVERSAL BATTENS IN CATALOG)

FLOAT KIT 30119 SCREW 8032011

"HOBIE" BATTEN LUFF PROTECTOR KIT 12480001

JIB COVER 1815 SNAP HOOK 53790040

JIB HOOK CLEW BLOCK 53790141 20680000

JIB SHEET RM516BLU X 32' DOWNHAUL RH014WHT X 5'

MAIN SAIL 37991XXX JIB SAIL 37992XXX

SEE SEQUENTIAL PRICE LIST OR SAIL COLOR SELECTION IN CATALOG

"S" HOOK 38900031 SHACKLE 11220000

UPPER BLOCK 37900021

MAIN SHEET RM038RED X 38'

LOWER BLOCK 37900011 CAM CLEAT RF5011 CAM CLEAT RF5015 FAIRLEAD 8030241 SCREW (2)

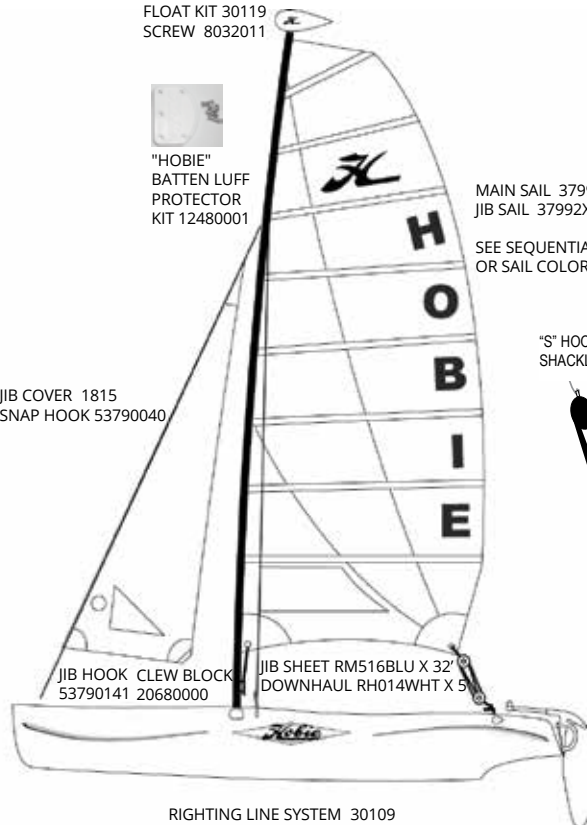

RIGHTING LINE SYSTEM 30109

MODEL / YEAR / ACCESSORY VARIATIONS

TILLER CROSSBAR 37521001 (OLDER RUDDER CASTINGS / M20 STYLE CONNECTORS)  
 TILLER CROSSBAR 37522001 (OLDER RUDDER CASTINGS / TENDON STYLE CONNECTORS)  
 TILLER CROSSBAR 37523001 (EZ LOC RUDDERS / TENDON CONNECTORS)

OLDER TILLER CONNECTOR PARTS

CLUB TILLER CONNECTOR (1954 / 1956)

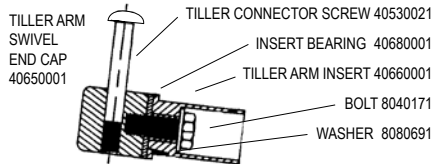

1956 KIT - CLUB TILLER CONNECTOR  
 (REPLACES TENDON STYLE WITH CLUB BOLT STYLE)  
 1954 KIT - CLUB TILLER CONNECTOR / UPGRADE FOR EARLY BOATS  
 WITH ORIGINAL CURVED TENDON CONNECTORS:  
 INCLUDES TILLER CROSS BAR AND ALL TILLER CONNECTOR FITTINGS

TENDON TILLER CONNECTOR

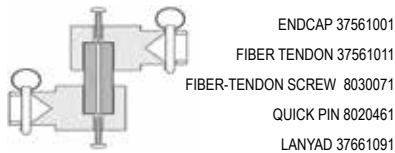

RUDDER PARTS

Pre-"EZ LOC" Rudder System

\* = SUB ASSEMBLY PART / INCLUDED WITH CASTING

ALUMINUM RUDDER CASTINGS

UPPER PINTLE 38101301  
 LOWER PINTLE 38101401  
 KEEPER PIN W/ LANYARD 38490011

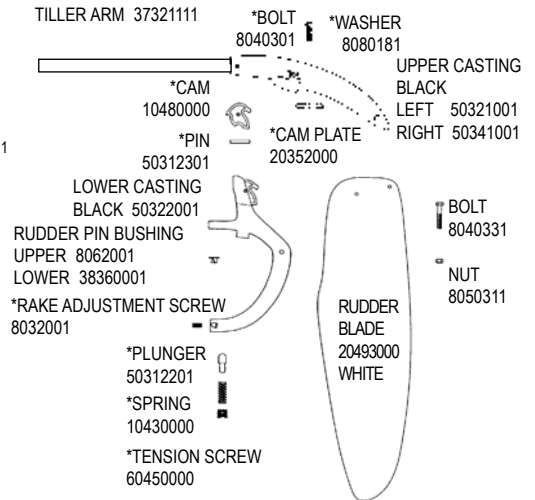

37001000 GETAWAY WING ASSEMBLY (WITH COVER)  
 (37001010 2017+)



GETAWAY RIVET GUIDE

( ) INDICATES QUANTITY NEEDED TO FASTEN PART

MAST

HEAD 8010121 (2)  
 HALYLARD HOOK 8011231 (2)  
 TANG 8010121 (12)  
 8011291 (12)  
 BUNGEE PAD EYE 8010181 (2)  
 8011291 (2)  
 HALYARD CLEAT 8010121 (2)  
 8011291 (2)  
 BASE 8010131 (4)  
 8011291 (4)

BOW SPREADER BAR

PLATES, BRIDLE BOW TANG 8010181 (4)  
 INTERNAL STIFFENER 8010201 (4)

MAIN CROSSBAR

BEAM STOP PLATES 8010181 (6)  
 CLEAT 8010181 (1)  
 PADEYES 8010181 (4)  
 JAM CLEAT 8010131 (1)  
 CLEATS, SWIVEL 8010131 (6)  
 PADEYES 8010131 (4)  
 END CAPS 8010201 (10)

REAR CROSS BAR

PADEYE 8010181 (2)  
 BEAM STOP PLATES 8010181 (6)  
 CLEAT PLATE 8010131 (4)  
 TRAMP LACE POSTS 8011231 (10)  
 END CAPS 8010201 (8)

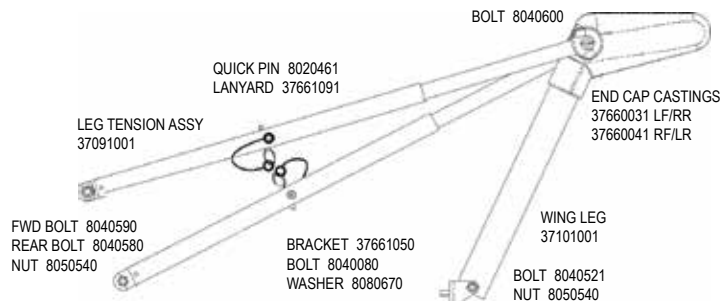

# HOBIE H14 / H16

REPLACEMENT HULL H16 WHITE - LEFT  
25010001  
REPLACEMENT HULL H16 WHITE - RIGHT  
25020001

Decals -  
12452161 "16" Silver  
12452121 "Hobie Cat" Black  
12451061 "Hobie" Diamond 36" Silver  
12452000 Silver pin stripe (ft)

Older Decals -  
12452160 "16" Silver  
12451130 "Hobie" Red Each  
12452000 Silver pin stripe (ft)

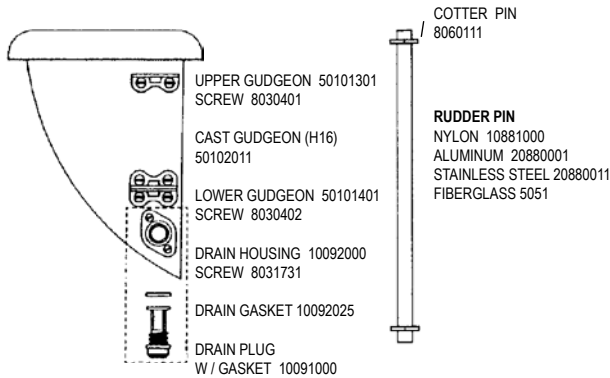
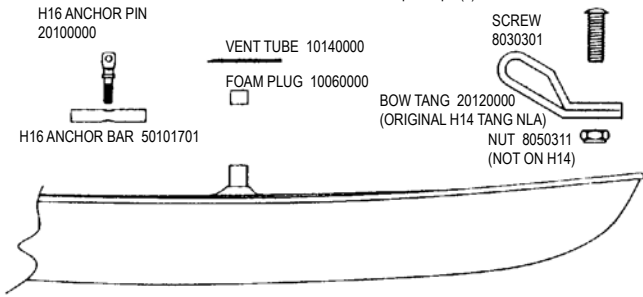

COMPLETE BOAT LINE PACKAGE 20781001

## H14 / H16 TRAMPOLINE, SIDEBAR

H14 COMPLETE TRAMPOLINE  
(Does not include lace lines)  
1097XXXX  
(XXXX = Color / See parts list for available options)

H16 COMPLETE TRAMPOLINE  
(Does not include lace line)  
2097XXXX  
(XXXX = Color / See parts list for available options)

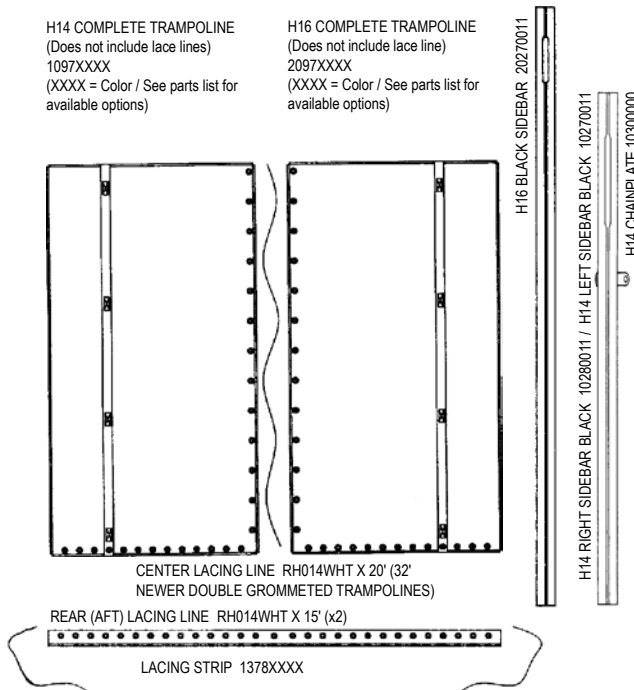

## H14 / H16 FRONT CROSSBAR

H14 BLACK FRONT CROSSBAR W/MAST STEP 10131910  
H16 BLACK FRONT CROSSBAR W/MAST STEP / INTEGRATED TRACK 25131910

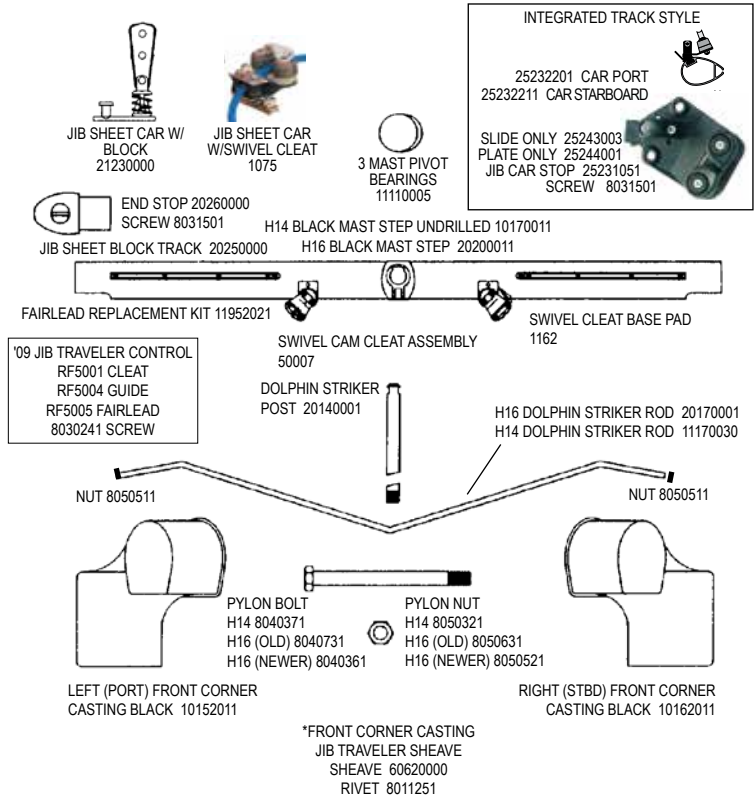

## H14 / H16 REAR CROSSBAR

CROSSBAR EXTRUSION w/ INTEGRATED TRACK, REAR (AFT)  
WITHOUT CORNER CASTINGS, BLACK - INCLUDES CAR ACCESS PLATE  
H16 25191911  
H14 10191910  
'94 AND NEWER CAR ACCESS PLATE 11810011

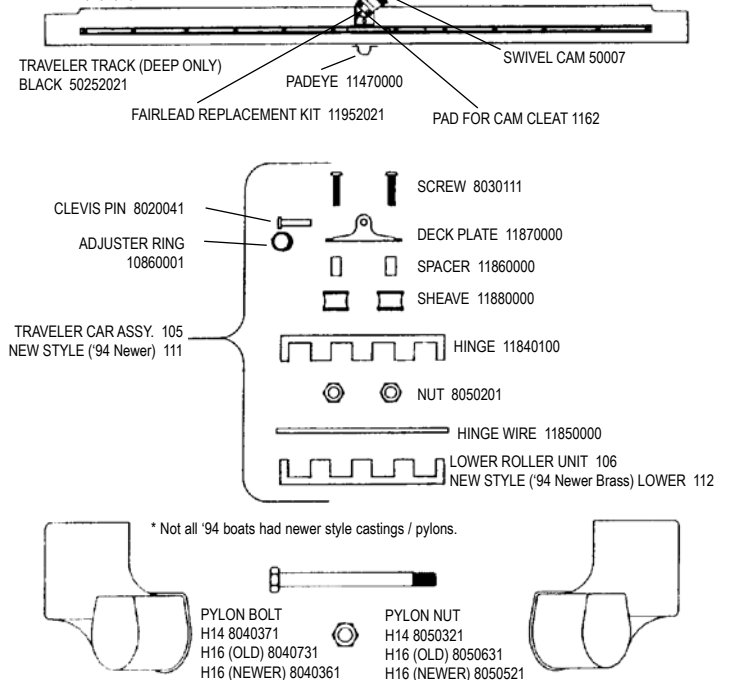

BLACK LEFT REAR CORNER CASTING 10212011

BLACK RIGHT REAR CORNER CASTING 10202011

**H14 / H16 RUDDER**

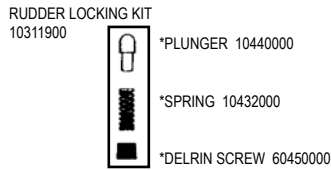
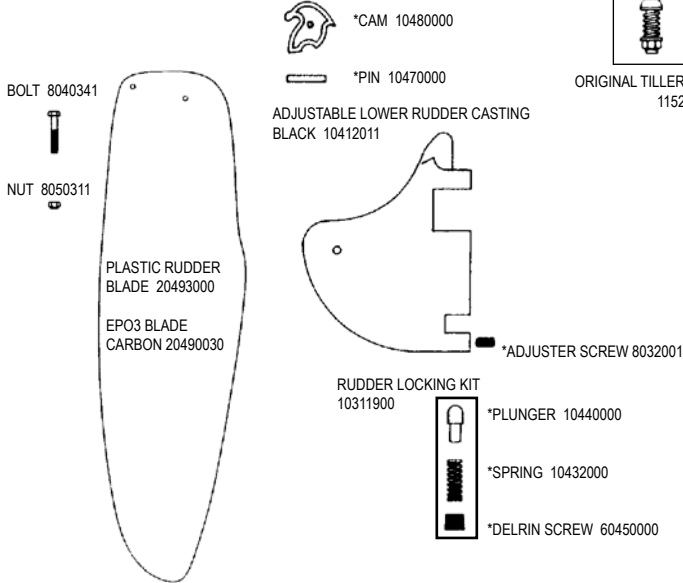
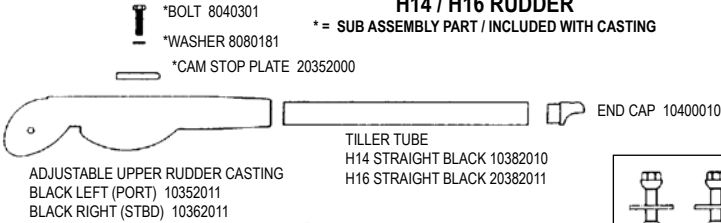

**H14 / H16 MAST**

H14 COMPLETE MAST ASSEMBLY BLACK 10581100  
H14 COMPTIP ASSEMBLY 10582100  
H16 COMPLETE MAST ASSEMBLY BLACK 20610000  
H16 COMPTIP ASSEMBLY 20611100

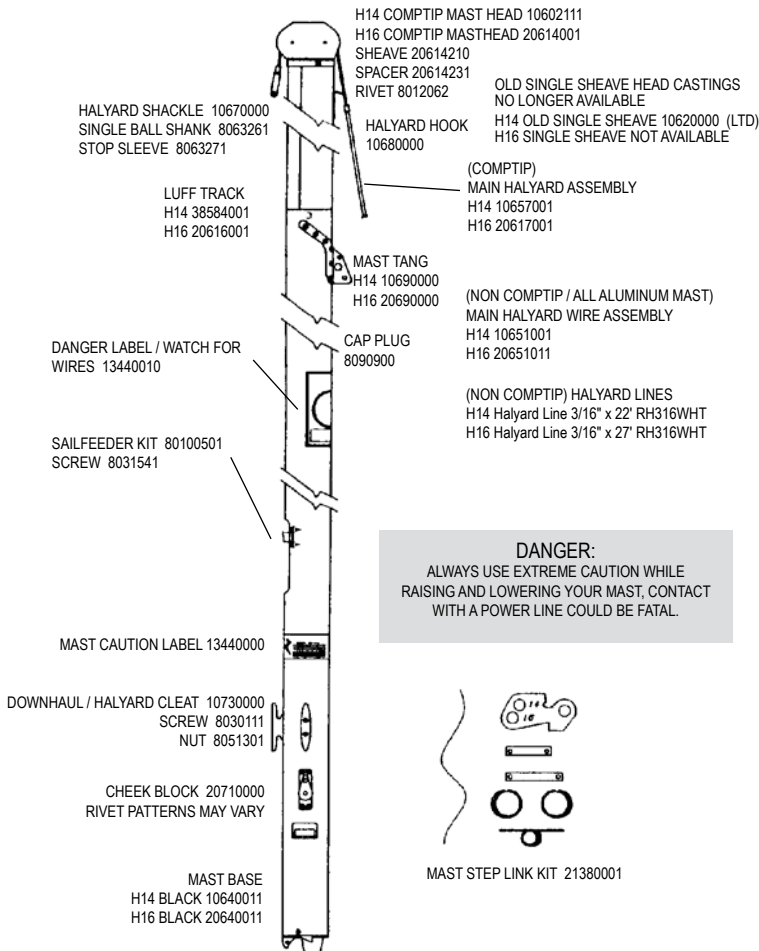

**DANGER:**  
ALWAYS USE EXTREME CAUTION WHILE RAISING AND LOWERING YOUR MAST, CONTACT WITH A POWER LINE COULD BE FATAL.

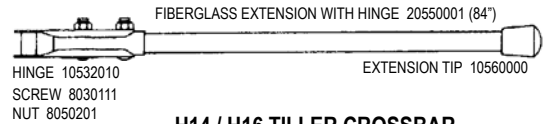
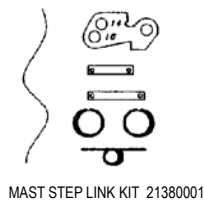

**H14 / H16 TILLER CROSSBAR**

H14 TILLER CROSSBAR BLACK 10520011  
H16 TILLER CROSSBAR ORIGINAL BLACK 20520011

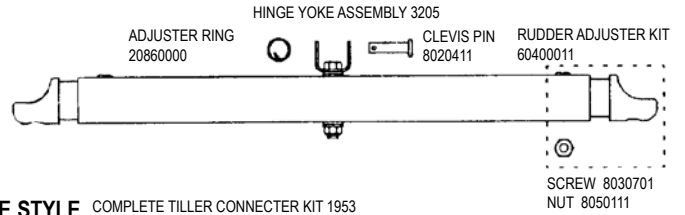

**MIRACLE STYLE COMPLETE TILLER CONNECTER KIT 1953**

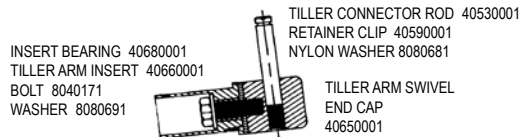

**MIRACLE STYLE TILLER CROSSBAR**

H16 TILLER CROSSBAR - MIRACLE 20521001

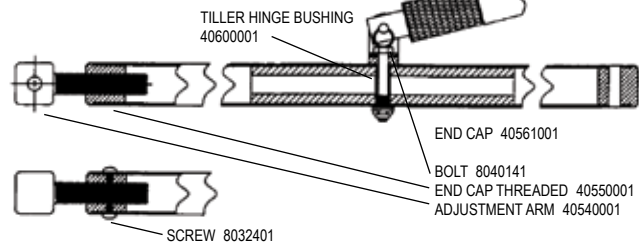

**H14 Rivet Guide**

( ) = Quantity needed to fasten part

**Mast**

Head	8010131 (2)
Halyard Hook	8010181 (2)
	8011291 (2)
Tang	8010181 (6)
	8011291 (6)
Halyard Cleat	8010121 (2)
Base	8010131 (3)
<b>Sidebar</b>	
Chain Plate	8010181 (3)
<b>Rear Crossbar</b>	
Corner Casting	8011231 (6)
Traveler Track	8010201 (18)
or	8010161 (18)
Pad Eye	8010181 (2)
Swivel Jam Cleat	8010201 (1)
	8031501 (2)
	8031231 (1)
	8050801 (1)
	8080101 (1)

**Boom**

Front End Cap	8010131 (3)
Tang	8010181 (4)
Barrel Cleat	8010181 (2)
Block Hanger	8010181 (4)
Rear End Cap	8010131 (3)

**Front Crossbar**

Mast Step	8011231 (4)
Corner Casting	8011231 (6)

**Rudder Assembly**

Upper Casting	8010131 (2)
(Underside)	8011231 (1)
Tiller End Cap	8010131 (2)

**Sail**

Headboard	8010020 (16)
Tack/Clew plate	8010020 (6)
Pocket Protector	8010020 (4)
(Requires setting machine-not available as hand tool)	

**H16 Rivet Guide**

( ) = Quantity needed to fasten part

**Mast**

Head	8010131 (4)
Halyard Hook	8011231 (4)
	8011291 (2)
Tang	8010181 (12)
	8011291 (12)
Halyard Cleat	8010121 (2)
Base	8010131 (3)
Downhaul Cheek Block	8010181 (4)
	8011291 (4)

**Front Crossbar**

Corner Casting	8011231 (6)
Mast Step	8011231 (4)
Jib Track	8010201 (6)
Swivel Jam Cleat	8010201 (1)
or	8010131 (1)
	8031501 (2)
	8010131 (1)
	8050801 (1)
	8080101 (1)

**Rudder Assembly**

Upper Casting	8010131 (2)
(underside)	8011231 (1)
Tiller End Cap	8010131 (2)

**Boom**

Front End Cap	8010131 (3)
Tang	8010181 (4)
Barrel Cleat	8010181 (2)
Block Hanger	8010181 (4)
Rear End Cap	8010131 (2)

**Rear Crossbar**

Corner Casting	8011231 (6)
Traveler Track	8010201 (20)
Pad Eye	8010181 (2)
Swivel Jam Cleat	8010201 (1)
	8031501 (2)
	8031231 (1)
	8050801 (1)
	8080101 (1)

**Sail**

Main Headboard	8010020 (16)
Tack/Clew Plate	8010020 (6)
Main Pocket Prtc	8010020 (4)
Jib Clew Plate	8010020 (16)
Jib Pocket Prtc	8010020 (3)

H14 / H16 FORESTAY ASSEMBLIES

- H14 FORESTAY BLACK 10812101
- H16 UPPER FORESTAY (PIG TAIL) 20810011

H16 JIB HALYARD AND LOWER FORESTAY

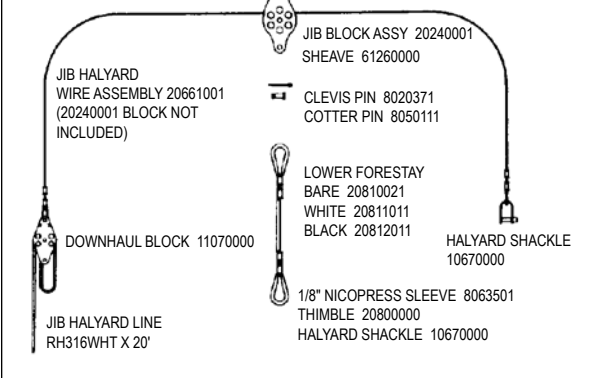

PIN AND RING SET 30303

CLEVIS PIN 8020381  
RING DING 20860000

10 HOLE STAY  
ADJUSTER 20830020

H14 BRIDLE BLACK 10822101

H16 BRIDLE WHITE 20820011  
H16 BRIDLE BLACK 20822011



SHACKLE 10700000



SHACKLES (FOR H14 WITH  
BOW PLATES) 10870000

H16 "AUSSIE" FORESTAY  
AND JIB HALYARD

80660000 Assembly

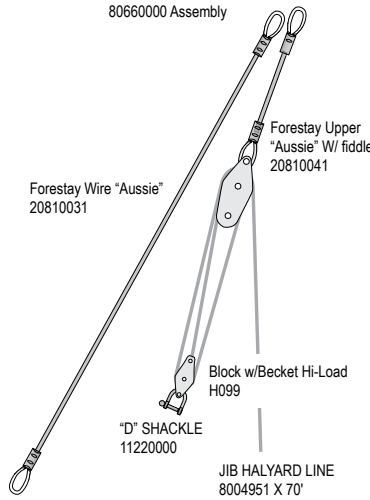

H14 / H16 SHROUDS



H14 SHACKLE 10700000  
H16 SHACKLE 20700001

H14 SHROUD BLACK 10792100  
H16 SHROUD WHITE 20790011  
H16 SHROUD BLACK 20792011

1/8" NICOPRESS SLEEVE 8063501  
THIMBLE 20800000

CLEVIS PIN 8020381  
RING DING 20860000

7 HOLE STAY ADJUSTER 20830010

CLEVIS PIN 8020371  
RING DING 20860000

TWIST TOGGLE 20210000

CLEVIS PIN 8020381  
RING DING 20860000

H16 TRAPEZE

SHROUD SHACKLE 10700000  
THIMBLE 20800000  
3/32" NICOPRESS SLEEVE 8063761

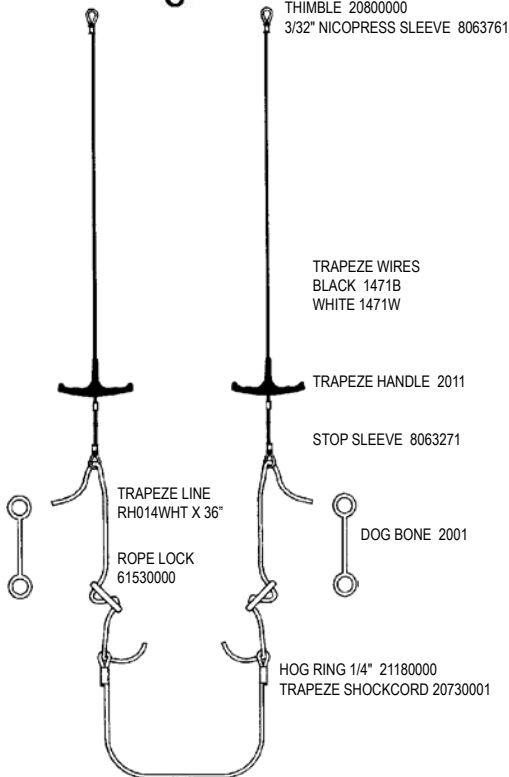

H14 TURBO RIGGING KIT

TURBO RIGGING KIT 80200000

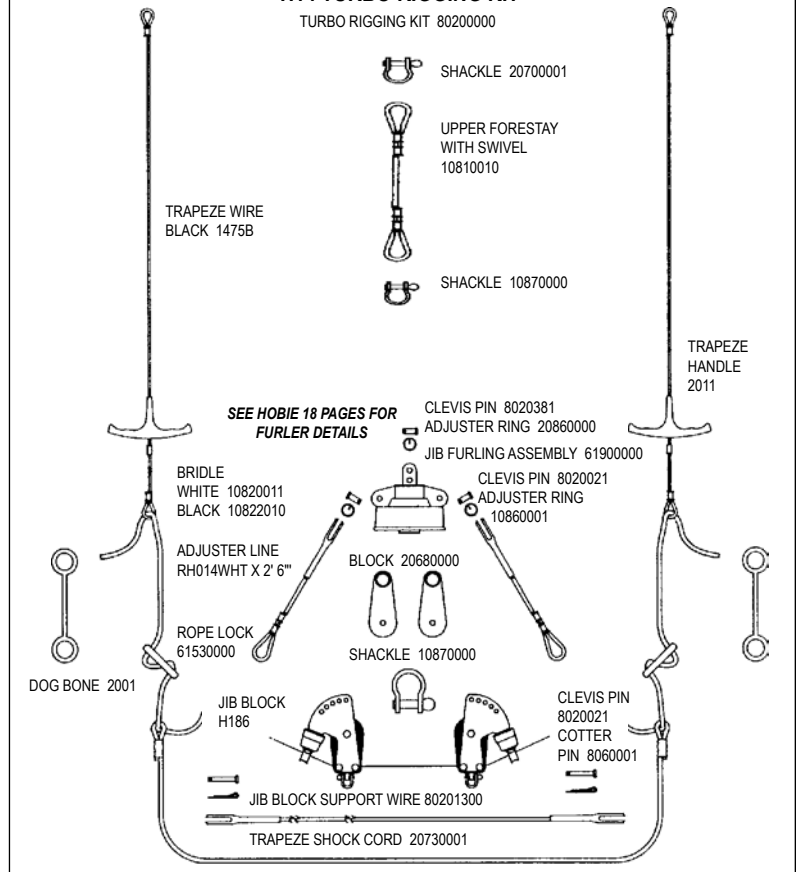

**H14 / H16 MAIN SAIL & BATTENS**

H14 MAIN SAIL 1099XXXX  
 H16 MAIN SAIL 20991XXX  
 SEE SEQUENTIAL PARTS LIST  
 OR SAIL COLOR SELECTION SHEET

HEADBOARD W/RIVETS  
 68330011

BATTEN POCKET  
 END PROTECTOR  
 KIT 80550005

"HOBIE"  
 PROTECTOR  
 KIT 12480001

PAIR OF WHITE HOBIE LOGOS 12430001  
 PAIR OF BLACK HOBIE LOGOS 12430011

H14 CLASS INSIGNIA 12440000  
 H16 CLASS INSIGNIA 22330000

SAIL WIND INDICATOR 335

LEECH BATTEN TIP 11323000

LUFF BATTEN TIP 11322011

BATTEN TIE LINE  
 RH112WHT X 18"

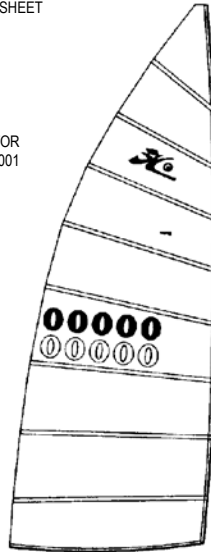

CLEW/TACK PLATE SET 12240000

SAIL BAG/COVER 21310000

**SAIL NUMBERS**

BLACK	
#0	12700030
#1	12710030
#2	12720030
#3	12730030
#4	12740030
#5	12750030
#6 & #9	12760030
#7	12770030
#8	12780030

**MAINSAIL BATTEN LENGTHS**

H16 BATTEN	H14 BATTEN
#8 41"	
#7 59 1/8"	
#6 72 1/8"	#6 42 11/16"
#5 82 3/8"	#5 60 7/16"
#4 90 3/4"	#4 74 1/16"
#3 97 3/8"	#3 84 13/16"
#2 103 7/8"	#2 93 5/16"
#1 107 7/8"	#1 97 7/16"

H16 MAIN BATTEN SET 21000001  
 (FOR INDIVIDUAL BATTENS SEE UNIVERSAL BATTENS PAGE)

**H14 / H16 JIB SAIL & BATTENS**

H14 JIB 10992XXX SEE SEQUENTIAL PARTS LIST  
 H16 JIB 20992XXX SEE SEQUENTIAL PARTS LIST

JIB HANK W/SCREW  
 22090001

SAIL WIND INDICATOR  
 334

BATTEN POCKET END  
 PROTECTOR 22080905

BATTEN TIE LINE  
 RH112WHT X 18"

JIB SHEET LINE  
 RM516XXX X 32'

BELL SHACKLE 10870000

JIB CLEW BLOCK 20680000  
 NEWER CONFIGURATION H224

ADJUSTABLE JIB CLEW PLATE 22240000

JIB LEACH CAP 21333000

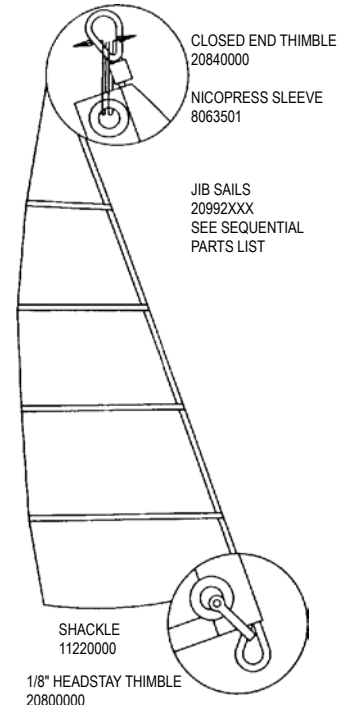

CLOSED END THIMBLE  
 20840000

NICOPRESS SLEEVE  
 8063501

JIB SAILS  
 20992XXX  
 SEE SEQUENTIAL  
 PARTS LIST

SHACKLE  
 11220000

1/8" HEADSTAY THIMBLE  
 20800000

- BATTEN #4 28"
- BATTEN #3 43 3/4"
- BATTEN #2 56"
- BATTEN #1 67"

H14 JIB BATTEN SET 20400001\*  
 (\* Current Production Lengths)  
 FOR INDIVIDUAL BATTENS SEE  
 UNIVERSAL BATTENS PAGE

**H14 / H16 BOOM**

H14 BOOM ASSEMBLY BLACK 10720011  
 H16 BOOM ASSEMBLY BLACK 20720011

REAR END CAP (UNDRILLED BLACK) 10741031      FRONT END CAP BLACK 10740011



BLOCK HANGER  
 10760000

BLACK PLASTIC BARREL CLEAT 10262000  
 STAINLESS V-JAM CLEAT 10261000

GOOSENECK ASSEMBLY  
 10770001

GOOSENECK BEARING  
 KIT 1511

OUTHAUL LINE RH316WHT X 7'4"

ADJUSTER RING  
 10860001

CLEVIS PIN 8020421  
 NEWER - BOLT 8040001

CLEVIS PIN 8020061

SHACKLE 10772020

NUT 8050121

VERTEX  
 50772031

SLIDE 10772001

"E" CLIP 8062521  
 FOR BOOM PIN  
 THAT IS GROOVED.  
 (OLD STYLE)

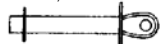

"BOOM PIN W/HOLE  
 (W/ROLL PIN) 10772010  
 ROLL PIN 50502201  
 FOR BOOM PIN  
 THAT HAS A HOLE.  
 (CURRENT STYLE)

BOLT  
 8040001

DOWNHAUL RING 10772070

COTTER PIN 8060101  
 NEWER - NUT 8050101

DOWNHAUL LINE RH316WHT X 5'

**H14 / H16 BLOCK SETS**

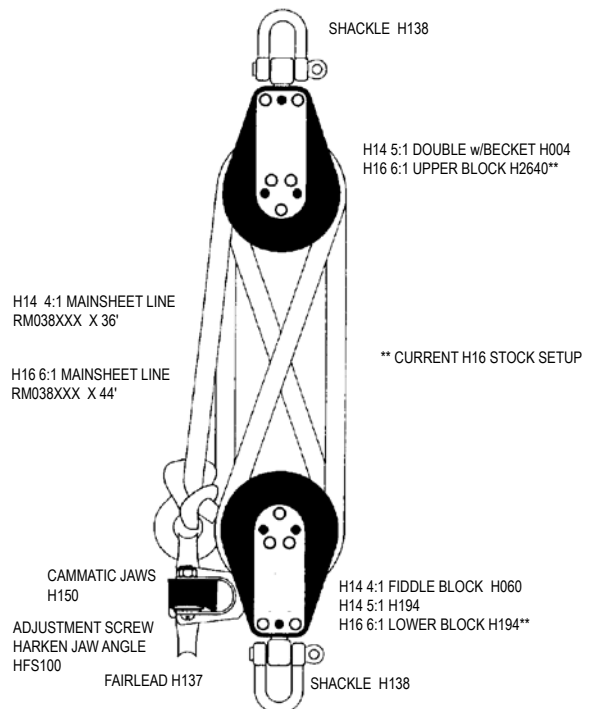

SHACKLE H138

H14 5:1 DOUBLE W/BCKET H004  
 H16 6:1 UPPER BLOCK H2640\*\*

H14 4:1 MAINSHEET LINE  
 RM038XXX X 36'

H16 6:1 MAINSHEET LINE  
 RM038XXX X 44'

\*\* CURRENT H16 STOCK SETUP

CAMMATIC JAWS  
 H150

H14 4:1 FIDDLE BLOCK H060  
 H14 5:1 H194  
 H16 6:1 LOWER BLOCK H194\*\*

ADJUSTMENT SCREW  
 HARKEN JAW ANGLE  
 HFS100

FAIRLEAD H137

SHACKLE H138

# HOBIE 17 / 17 SPORT

REPLACEMENT HULL WHITE - LEFT 50101001  
 REPLACEMENT HULL WHITE - RIGHT 50102001

Decals -  
 12451130 "Hobie" Red Each  
 12451061 "Hobie" Diamond 36" Silver  
 12452000 Silver pin stripe (ft)

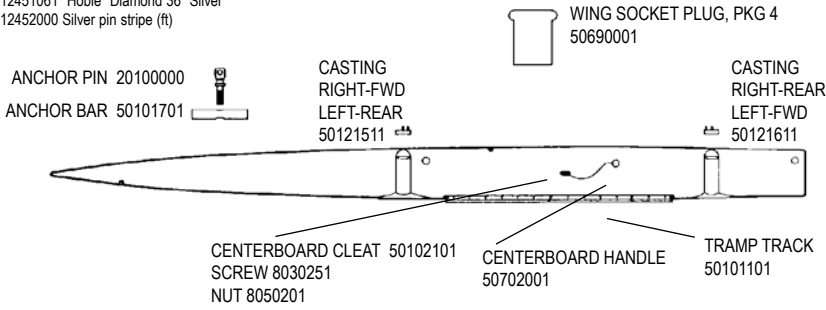

## H17 HULL/DECK

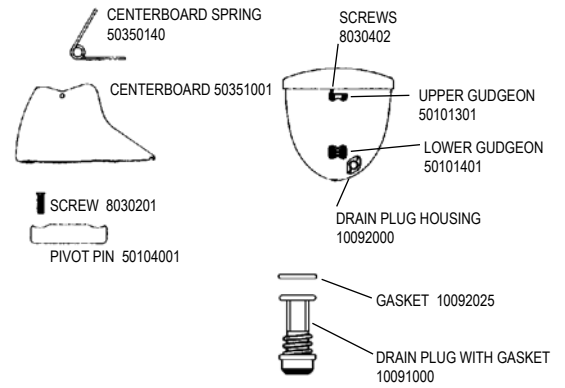

## FWD CROSSBAR EXTRUSION ONLY

BLACK 50221001

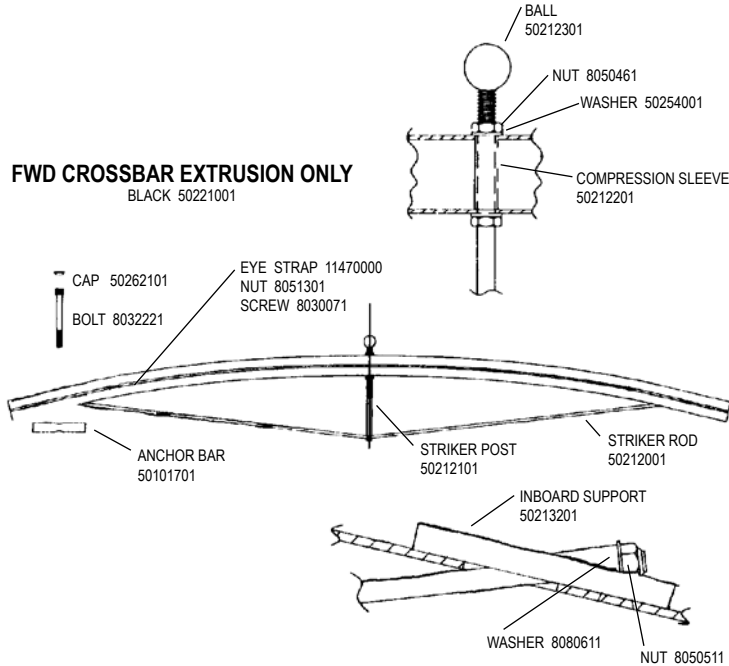

## H17 TRAMPOLINE

COMPLETE TRAMPOLINES (Does not include lace line)  
 5067XXXX  
 (XXXX = Color / See parts list for available options)

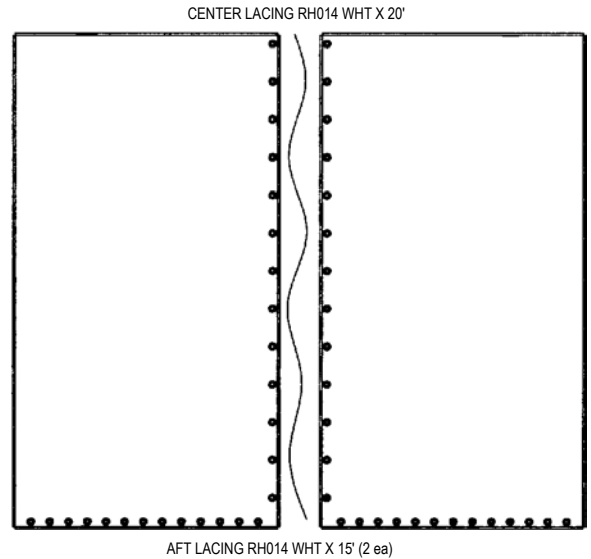

## REAR CROSSBAR EXTRUSION ONLY

BLACK 50261001

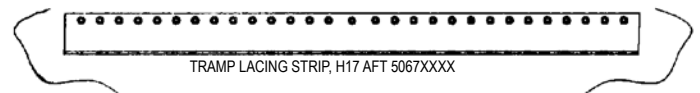
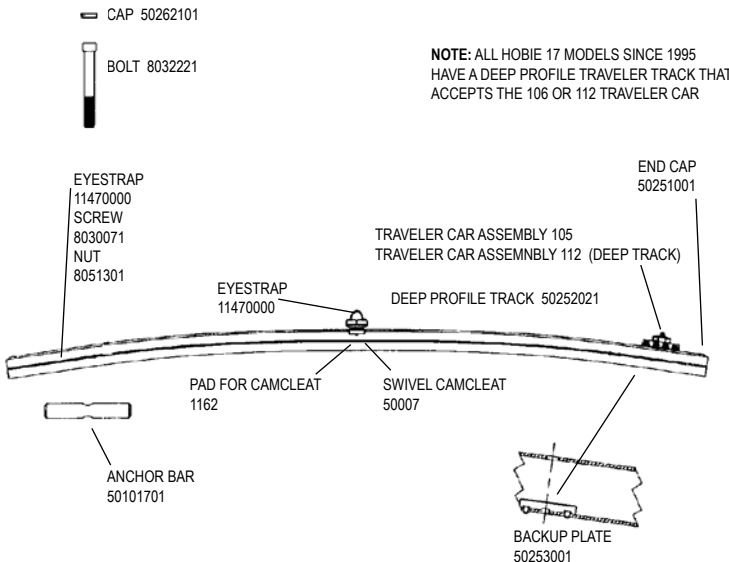

### H17 RUDDER ASSEMBLY

\* = SUB ASSEMBLY PART / INCLUDED WITH CASTING

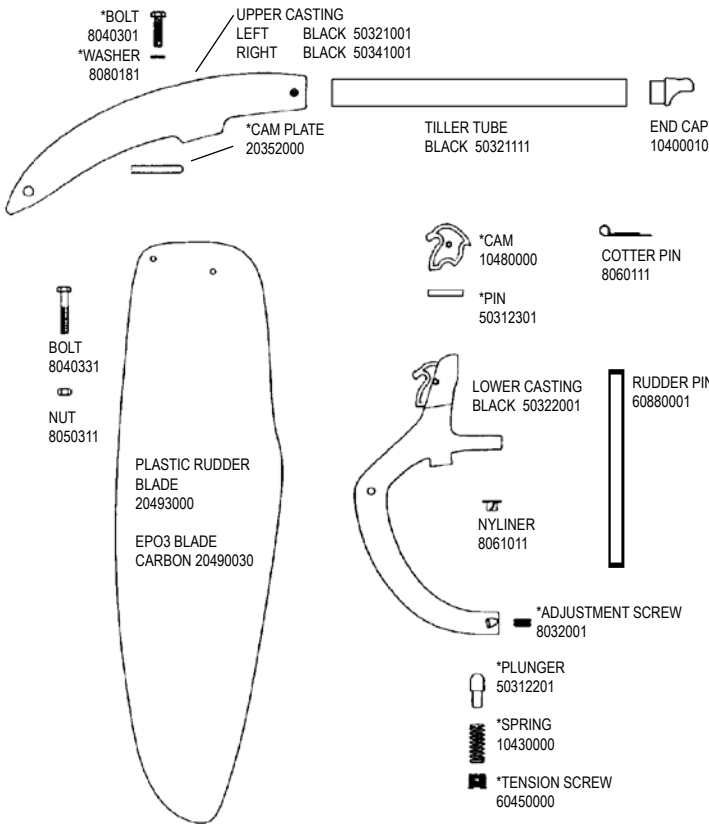

### H17 TILLER

TILLER CONNECTOR KIT 11520005

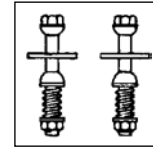

TILLER CROSSBAR BLACK 20520011  
'95 - NEWER 20521001

HINGE YOKE ASSY. 3205

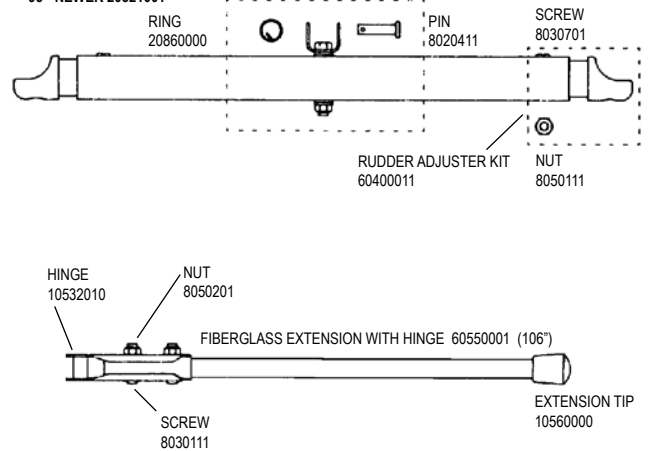

### H17 WIRES

(See following page for 17 Sport-Specific Wires)

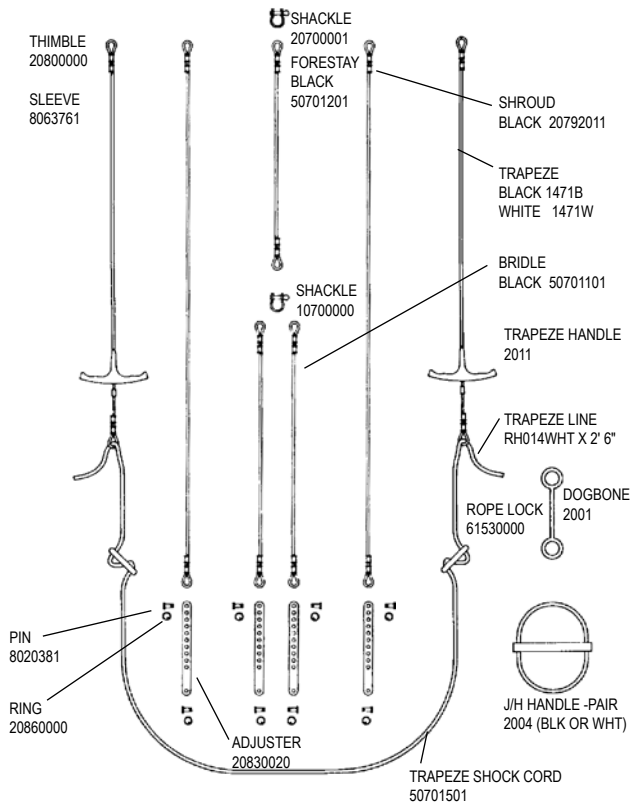

### H17 MAST

MAST ASSY. BLACK 51410000  
COMPTIP ASSY. 50611101

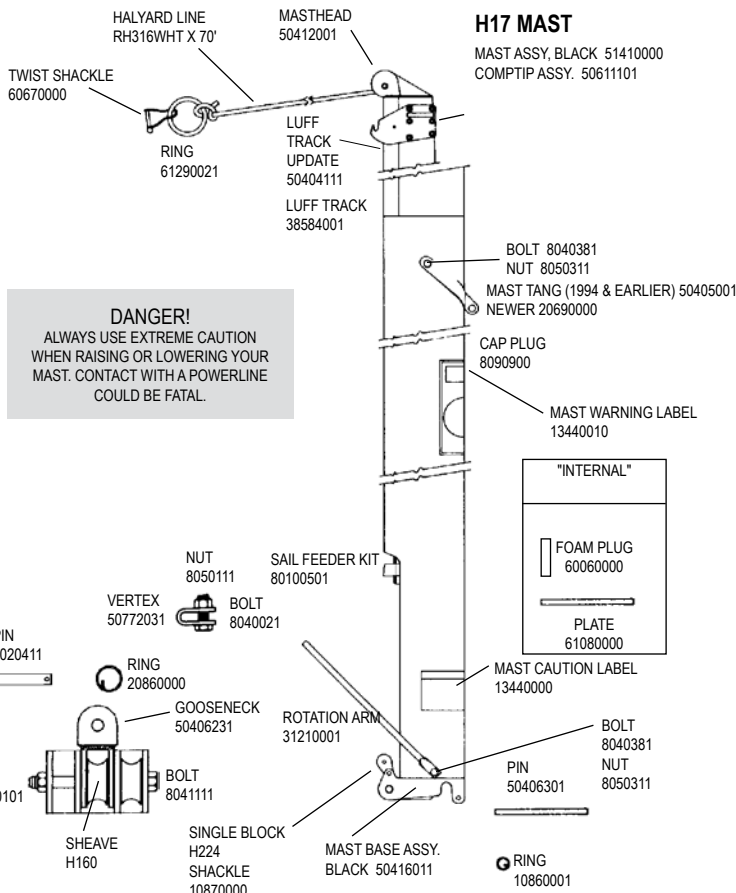

**DANGER!**  
ALWAYS USE EXTREME CAUTION WHEN RAISING OR LOWERING YOUR MAST. CONTACT WITH A POWERLINE COULD BE FATAL.

**H17 SAIL**

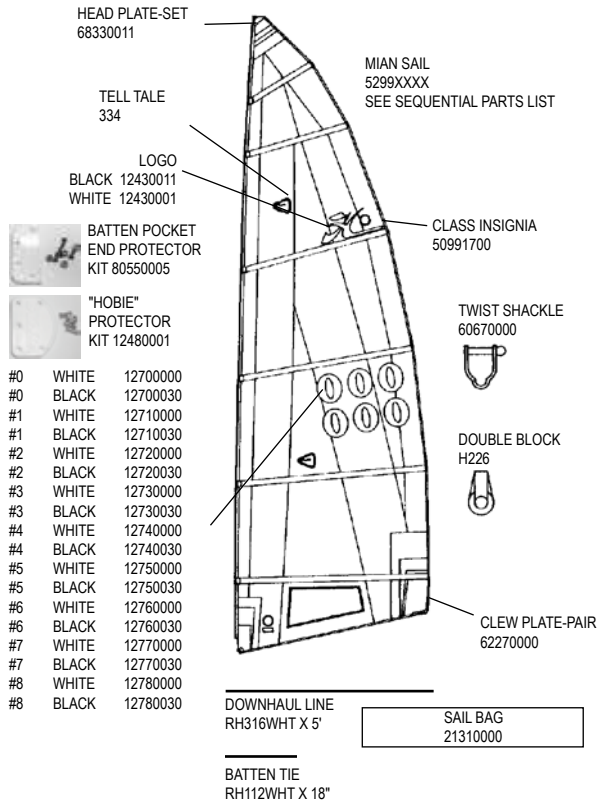

**H17 BLOCK SET**

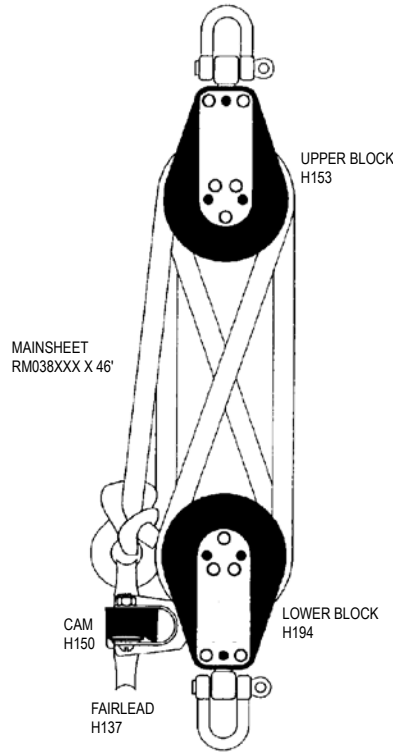

**H17 Rivet Guide**

( ) indicates quantity needed to fasten part

<b>Mast</b>	
Head	8010131 (2)
Halyard Hook	8011231 (3)
Base	8010131 (2)
<b>Rear Crossbar</b>	
Swivel Jammer	8010201 (1)
	8031501 (2)
	8031231 (2)
	8080011 (1)
	8050801 (1)
Dead Eye	8010181 (4)
Back Up Plate	8010201 (4)
Track	8010201 (44)
<b>Hull</b>	
Trampoline Track	8010121 (9)
(backup washers required on above,61360000)	
<b>Boom</b>	
End Cap (gooseneck)	8010131 (2)
Block Hanger	8010181 (4)
End Cap	8010131 (2)
<b>Rudder (Upper Casting)</b>	
Casting	8011231 (4)
End Cap	8010131 (2)
<b>Sail Hardware</b>	
Headboard	8010020 (16)
Main Clew Plate	8010020 (10)
Batten Pocket	8010020 (4)
Jib Clew Plate	8010020 (6)
(above rivets require setting machine which is not available in a hand tool)	
<b>Wing</b>	
End Cap	8010051 (1)
Castings	8010131 (8)
<b>Forward Cross Bar - Sport</b>	
Swivel Cam Cleats	8010131 (4)

**H17 BOOM**

BLACK 50510000

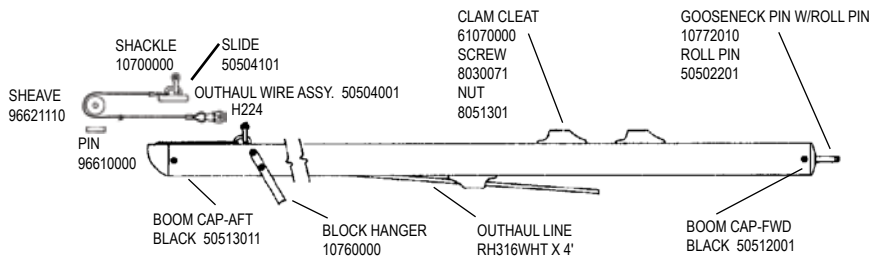

**H17 WINGS**  
SET W/O TRAMPOLINES  
50650000

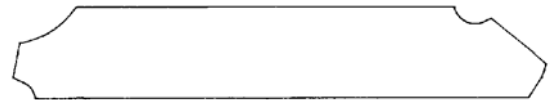

WING TRAMP SET  
5065XXXX  
(XXXX = Color / See parts list for available options)

**H17 / 17 SPORT BATTENS**

(FOR INDIVIDUAL BATTENS SEE UNIVERSAL BATTENS PAGE)

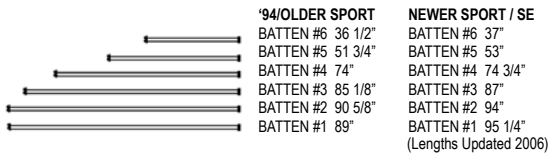

RIGHT-WING ASSY.  
50680001

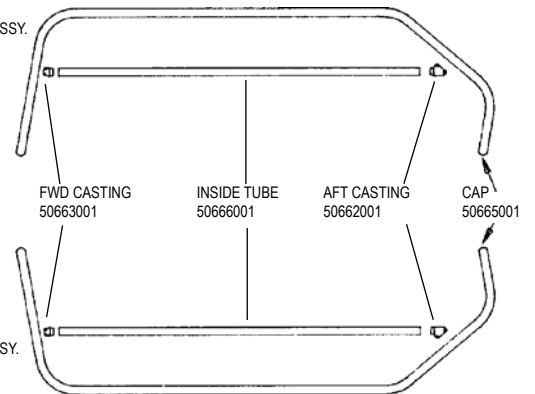

LEFT-WING ASSY.  
50660001



# HOBIE 17 SPORT SPECIFIC

NOTE: WHERE A SPECIFIC ITEM IS NOT IDENTIFIED, USE THE STANDARD HOBIE 17 LINE DRAWINGS.

## H17 SPORT FORESTAY

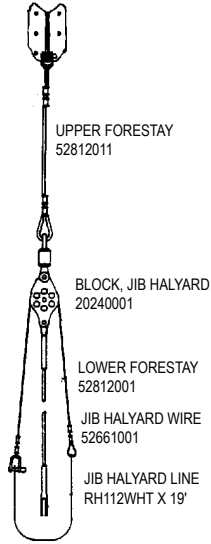

## SPORT BOOMLET ASSEMBLY (NEWER, 95 - CURRENT) 52722011



## ORIGINAL H17 SPORT REAR CROSSBAR, MAINSHEET SYSTEM AND OUTHAUL SYSTEM-1994 AND EARLIER

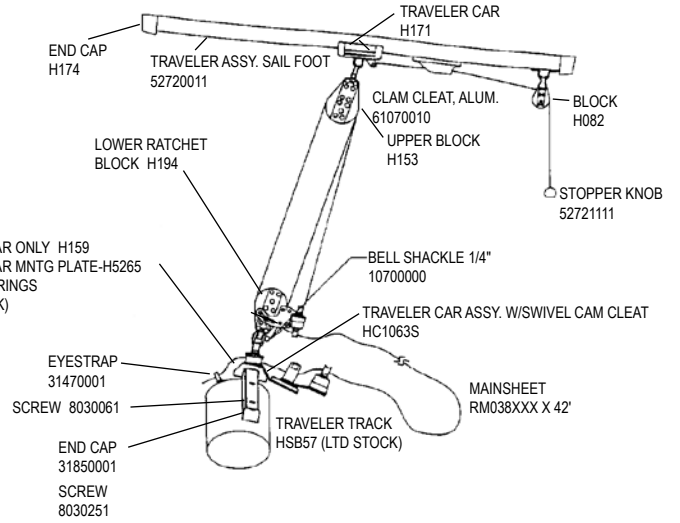

## H17 SPORT SPREADER POLE & FURLER

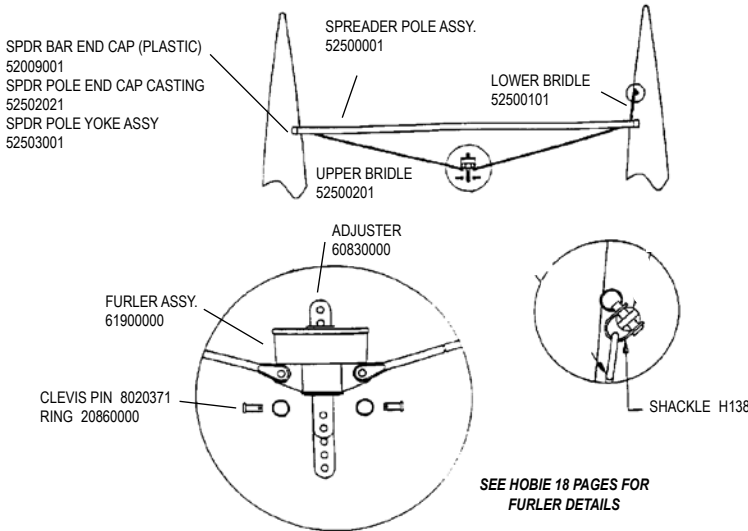

## H17 SPORT MAST ASSY. & DOWNHAUL

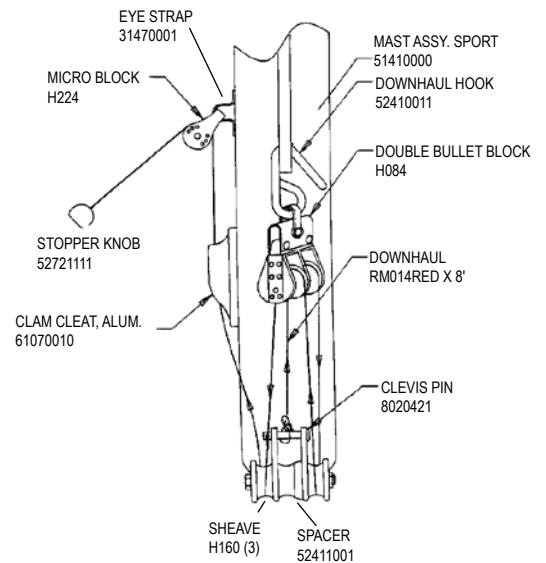

## H17 SPORT FRONT CROSSBAR

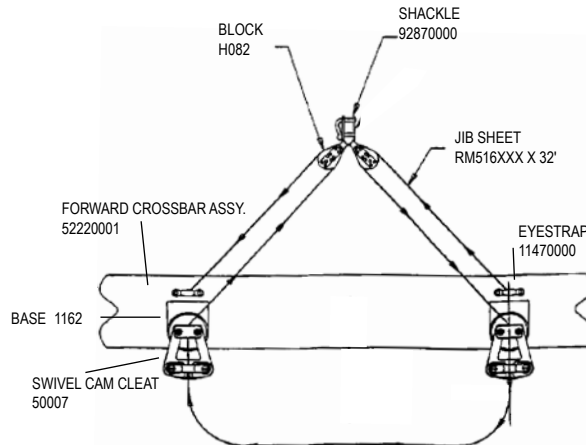

# HOBIE 18 / 18 SX

Decals -  
 12451130 "Hobie" Red Each  
 12451061 "Hobie" Diamond 36" Silver  
 12452000 Silver pin stripe (ft)

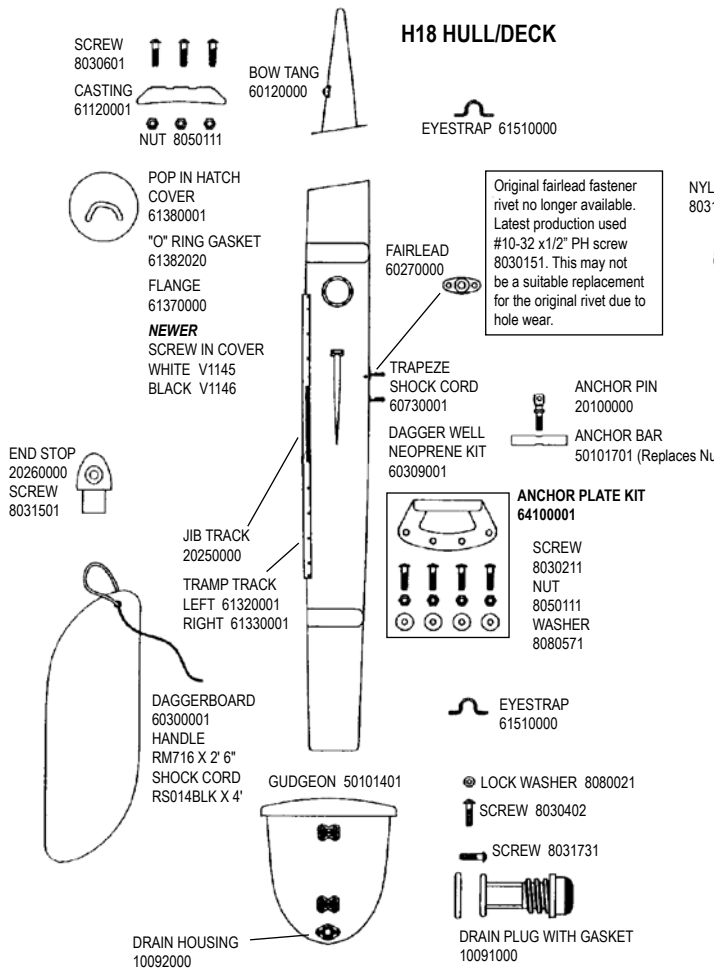

## H18 TRAMPOLINE

COMPLETE TRAMPOLINE 6097XXXX  
 (XXXX = Color / See parts list for available options)  
 (Does not include lace line)

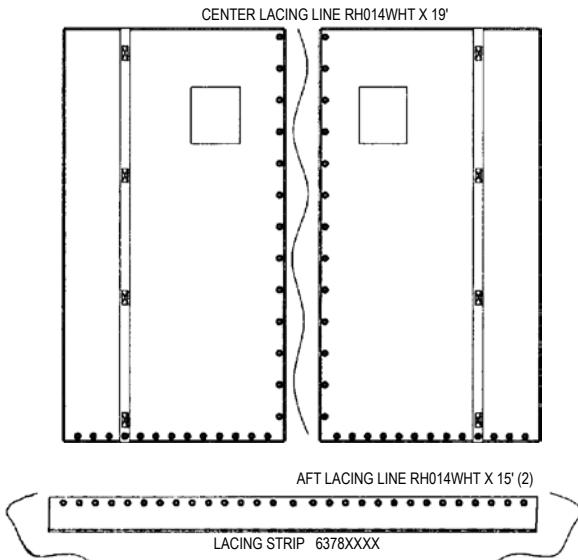

## H18 FWD CROSSBAR

CROSSBAR WITH STEP CASTING BLACK 60132010

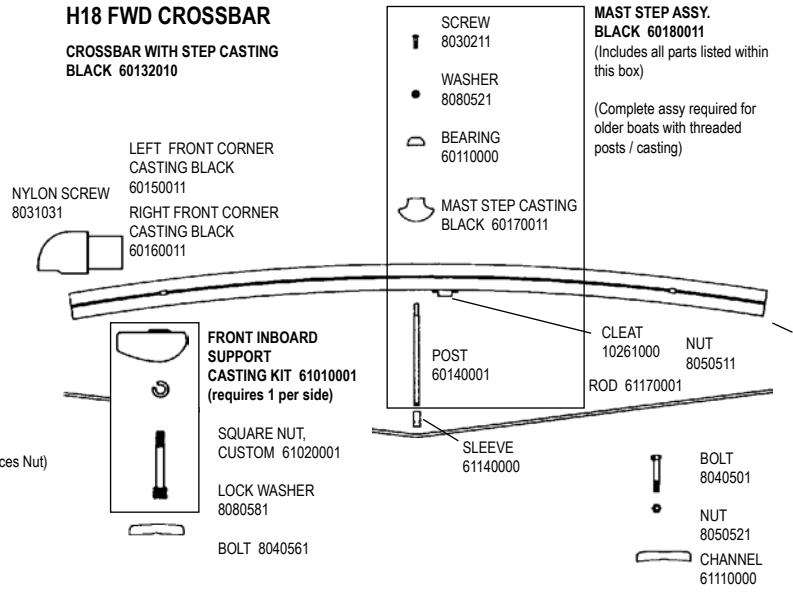

## H18 REAR CROSSBAR

REAR CROSSBAR - EXTRUSION ONLY BLACK 60191211

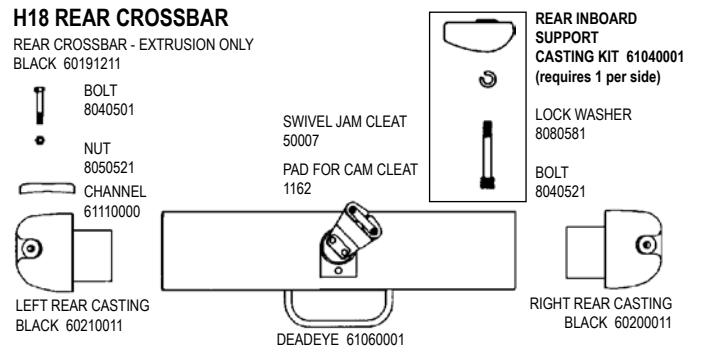

## H18 MAIN TRAVELER CAR

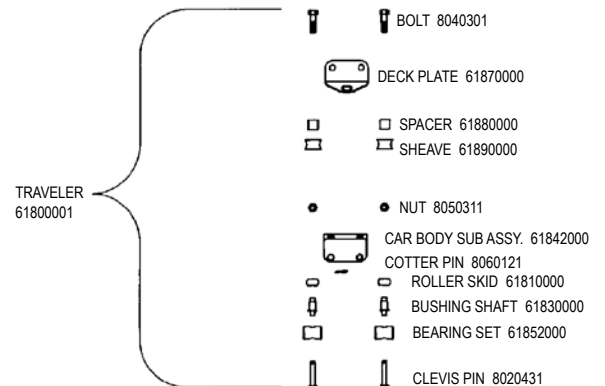

**H18 / H18SXRUDDER ASSEMBLY**

\* = SUB ASSEMBLY PART // INCLUDED WITH CASTING

1986 AND EARLIER  
60331010 CONVERSION KIT REQUIRED  
INCLUDES: UPPER CASTING ASSEMBLIES, TUBE, END CAP, LOWER CASTING ASSEMBLIES, NUTS, BOLTS, GUDGEONS. FOR BOTH SIDES.

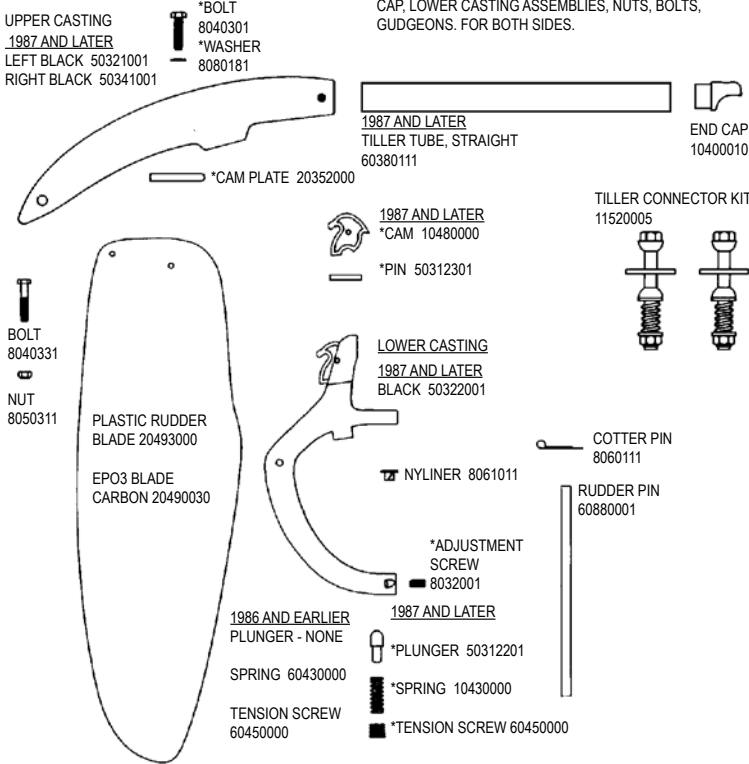

**H18 / H18SX TILLER CROSSBAR & EXTENSION**

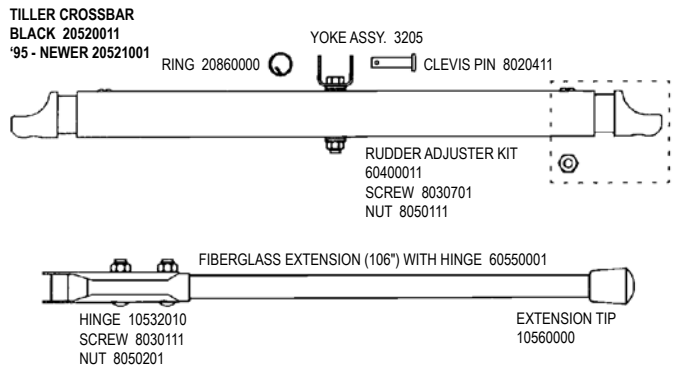

**H18 / H18SX MAST**

18 MAST ASSY. BLACK 60611001  
18SX MAST ASSY. BLACK 68581000

COMPTIP ASSEMBLY 60611100

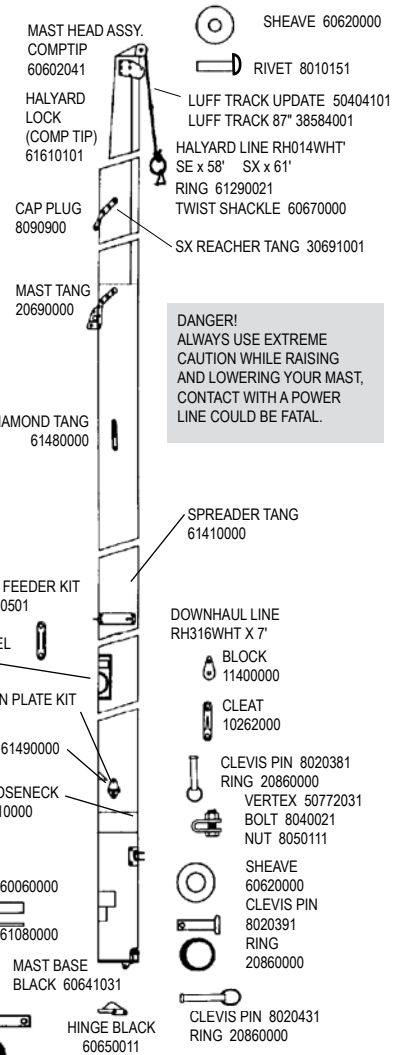

**H18 / H18SX DIAMOND WIRES**

18 DIAMOND WIRE 61750001  
18SX DIAMOND WIRE 68750001

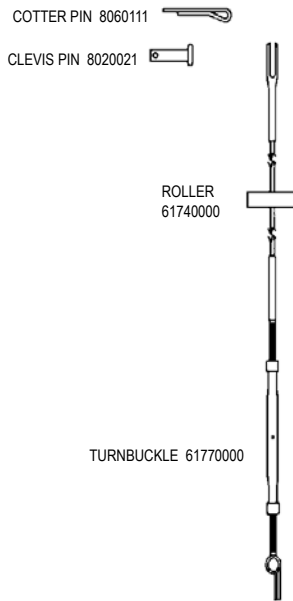

**H18 / H18SX SPREADERS**

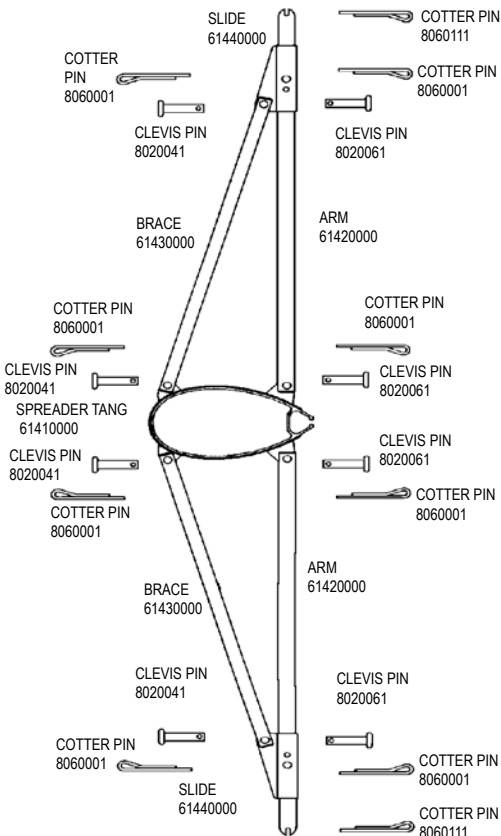

**H18 / H18SX ROTATION ARM**

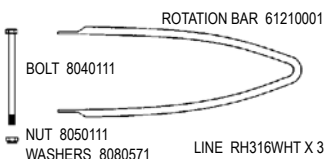

**H18 / H18SX FORESTAY & JIB HALYARD**

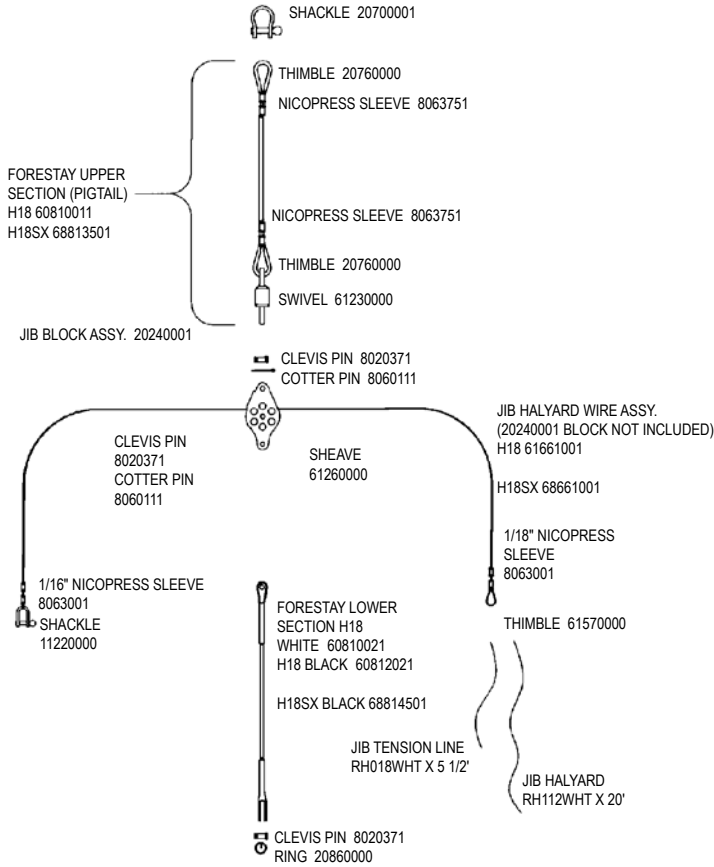

**H18 / H18SX ROLLER FURLER**

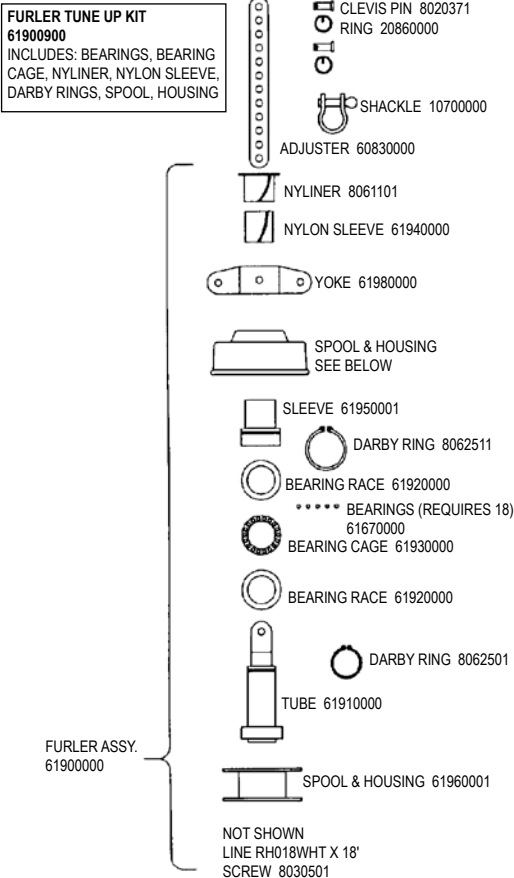

**H18 / H18SX SHROUDS & ADJUSTERS**

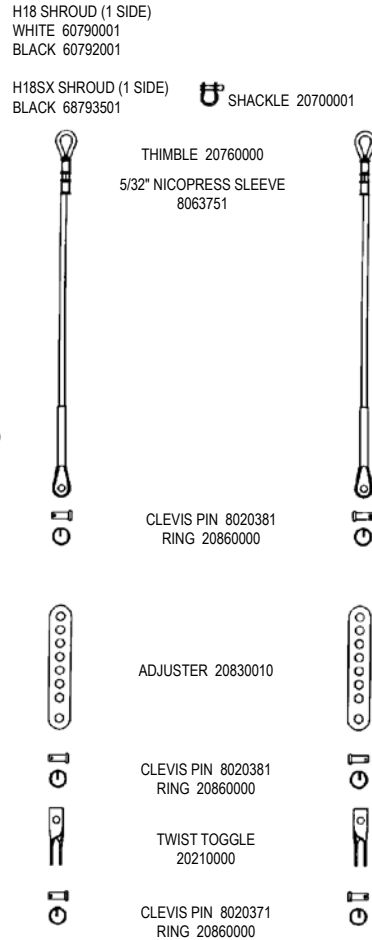

**H18 RIVET GUIDE**  
( ) Indicates quantity needed to fasten part.

<b>MAST</b>	
HEAD	8010131 (2)
HALYARD HOOK	8011231 (6)
TANG	8010181 (12)
DIAMOND TANG	8010181 (3)
SPREADER TANG	8010181 (8)
COMPRESSION PLATE	8010181 (4)
GOOSENECK PLATE	8010181 (4)
GOOSENECK CLEAR	8010131 (2)
GOOSENECK BLOCK	8010131 (2)
BASE	8010131 (2)
(Note: all 8010181 mast rivets require 08011291 rivet caps)	
<b>REAR CROSSBAR</b>	
CORNER CASTING	8011231 (6)
INBOARD SUPPORT	8010131 (2)
SWIVEL JAMMER	8010201 (1)
	8031501 (2)
	8031231 (1)
	8080011 (1)
	8050801 (1)
DEAD EYE	8010181 (4)
<b>HULL</b>	
TRAMPOLINE TRACK	8010121 (9)
(backup washers required on above, 8080551)	
ACCESS PORT FLANGE	8010141 (12)
EYE STRAP	8010131 (2)
<b>BOOM</b>	
END CAP	8010131 (2)
<b>FRONT CROSSBAR</b>	
MAST STEP	8010131 (4)
INBOARD SUPPORT	8010131 (2)
JAM CLEAT	8010181 (2)
<b>RUDDER (UPPER CASTING)</b>	
CASTING	8011231 (3)
END CAP	8010131 (2)
<b>SAIL HARDWARE</b>	
HEADBOARD	8010020 (16)
MAIN CLEW PLATE	8010020 (10)
BATTEN POCKET	8010020 (4)
JIB CLEW PLATE	8010020 (6)
(above rivets requires setting machine which is not available in a hand tool.)	

**H18 / H18SX TRAPEZE WIRES**



**H18 / H18SX BRIDLES**

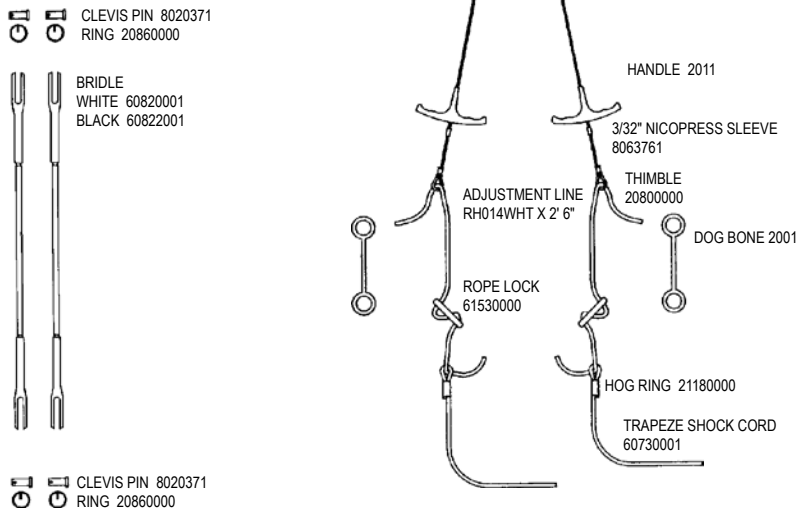

### H18 MAIN SAIL & BATTENS

H18 60991XXX / H18SX 68991XXX  
SEE NUMERICAL SECTION



HOBIE 18		HOBIE 18SX	
BATTEN #10	24 1/8"	BATTEN #9	28 1/2"
BATTEN #9	39 1/16"	BATTEN #8	46 1/8"
BATTEN #8	56 5/16"	BATTEN #7	67 7/8"
BATTEN #7	68 13/16"	BATTEN #6	83 5/16"
BATTEN #6	79 5/16"	BATTEN #5	93 7/8"
BATTEN #5	87 5/16"	BATTEN #4	100 9/16"
BATTEN #4	93 7/8"	BATTEN #3	103 3/4"
BATTEN #3	97 5/16"	BATTEN #2	104 11/16"
BATTEN #2	101 5/16"	BATTEN #1	102 11/16"
BATTEN #1	101 5/16"		

(FOR INDIVIDUAL BATTENS SEE UNIVERSAL BATTENS PAGE)

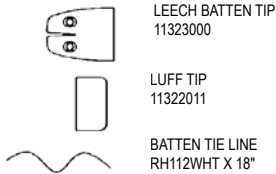

LEECH BATTEN TIP  
11323000

LUFF TIP  
11322011

BATTEN TIE LINE  
RH112WHT X 18"

#### 14" SAIL NUMBERS

	BLACK	WHITE
#1	12710030	12710000
#2	12720030	12720000
#3	12730030	12730000
#4	12740030	12740000
#5	12750030	12750000
#6&9	12760030	12760000
#7	12770030	12770000
#8	12780030	12780000
#0	12700030	12700000



MAIN CLEW PLATE-PAIR (W/RIVETS) 62270000

SAIL BAG 21310000

SAIL WIND INDICATOR  
335

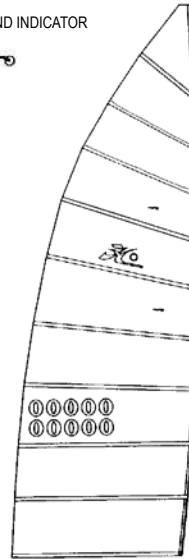

HEADBOARD WRIVETS  
68330011

LOGO (PAIR)  
WHITE 12430001  
BLACK 12430011

CLASS INSIGNIA  
62330000

BATTEN POCKET  
END PROTECTOR  
KIT 80550005

"HOBIE"  
PROTECTOR  
KIT 12480001

JIB SAIL  
H18 60992XXX  
H18SX 68992XXX

ZIPPER  
62300000

CLEW  
PLATE  
12240000

LUFF CLEAT KIT  
62260001

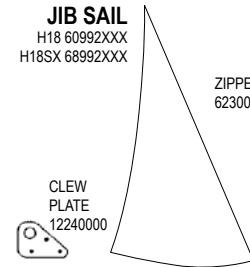

### H18 / H18SX BOOM

BOOM ASSEMBLY BLACK  
60720011

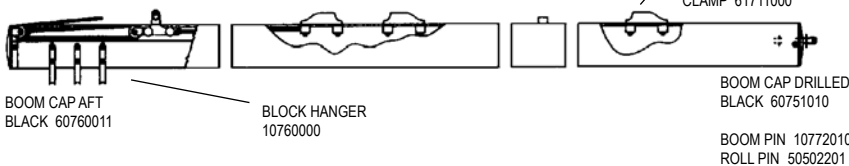

BOOM CAP AFT  
BLACK 60760011

BLOCK HANGER  
10760000

CLEAT 61070000  
SCREW 8031011  
CLAMP 61711000

BOOM CAP DRILLED  
BLACK 60751010

BOOM PIN 10772010  
ROLL PIN 50502201

OUTHHAUL CAR ASSY 60220001 (OUTHHAUL AND SHOCK CORD NOT INCLUDED)

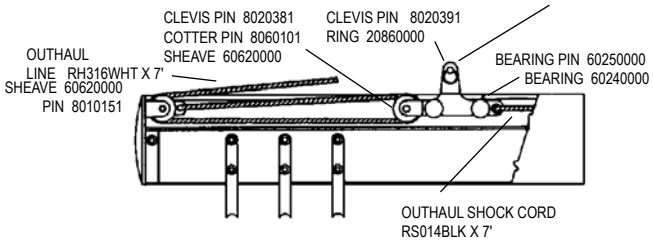

CLEVIS PIN 8020381  
COTTER PIN 8060101  
SHEAVE 60620000

CLEVIS PIN 8020391  
RING 20860000

BEARING PIN 60250000  
BEARING 60240000

OUTHHAUL  
LINE RH316WHT X 7'  
SHEAVE 60620000  
PIN 8010151

OUTHHAUL SHOCK CORD  
RS014BLK X 7'

SHACKLE 10870000

CLEW BLOCK 20680000

JIB SHEET BLOCK  
HARKEN 60330041

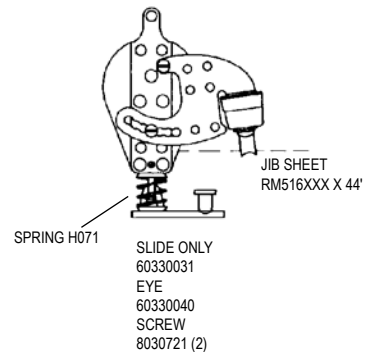

JIB SHEET  
RM516XXX X 44'

SPRING H071

SLIDE ONLY  
60330031  
EYE  
60330040  
SCREW  
8030721 (2)

### H18 BLOCK SET WITH LINE

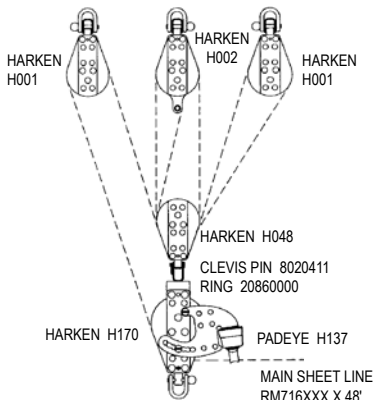

HARKEN  
H001

HARKEN  
H002

HARKEN  
H001

HARKEN H048

CLEVIS PIN 8020411  
RING 20860000

HARKEN H170

PADEYE H137

MAIN SHEET LINE  
RM716XXX X 48'

WING TRAMP SET BLACK 68040255  
(does not include lace line)



INDEX

Part	Description	OS	OS = Oversized item / Additional handling charges apply
105	TRAVELER CAR ASSY, T-2	-	2102 SHOCK CORD FASTENER (SCH) 5/16
106	LOWER ROLLER UNIT T-1 (PRE-95)	-	3041 LICENSE FRAME - FLY A HOBIE
111	TRAVELER CAR ASSY BRASS	-	3042 LICENSE FRAME - 10" RATHER BE
112	LOWER ROLLER UNIT BRASS	-	3043 LICENSE FRAME - CHROME "HOBIE"
114	HALYARD GRIP	-	3052 TILLER CONNECTOR DLX KIT
122	BATTENS-SSI SUPER JIB SET	OS	3062 SHACKLE, FAST
136	RUDDER STIFFENING KIT	-	3064 HALYARD RING-AUSSIE
176	TRAP STAYS	-	3091 PADDLE, TELESCOPING 20"-39"
204	THIRD HAND	-	3101 TRAPEZE RIG KIT, W/DWG BN
334	AIR FLOW TELS, RED / GREEN	-	3102 TRAPEZE RIG KIT W/O BONES
370	SHOCK CORD BALL TIES	-	3103 BLOCK, MINI W/AXLE
374	TELO CAT, COLLAR, SET SCREW	-	3121 DELUXE SAIL BAG
376	SILICON RTV 100% 3 OZ.	-	3125 COMPTIP COVER, H16/18/20
377	TELO CAT	-	3127 COMPTIP COVER,HOBIE 17/21
378	TELO CAT REPLACEMENT VANE	-	3128 BAG TRAMP STORAGE W/ MAP
610	BOOK, CATAMARAN SAILING	-	3152 HOBIE MAST STEPPER
790	FIBERGLASS STAIN REMOVER	-	3155 HOBIE MAST STEPPER II
1071	JIB TRAV. TRIM KIT W/SW.	-	3156 HOBIE MAST STEPPER III
1073	JIB TRAV. TRIM KIT	-	3175 MAST CRADLE HOBIE
1075	SWIVEL CAM CLEAT / CAR + CLEAT	-	3180 MOTOR MOUNT - H14/WAVE/16"/17
1076	SWIVEL CAM CLEAT / CAR	-	3183 MOTOR MOUNT- WAVE NON-EZ LOC
1125	CAN HOLDER, TRAMP/WING	-	3184 MOTOR MOUNT - GETAWAY
1132	MAST BEARING W/DISK KIT - H18	-	3205 HIKING STICK YOKE CONN.
1161	MOUNTING PLATE W/O HDWRE	-	3206 BLACK FOAM GRIP .570 X 11"
1162	MOUNTING PLATE W/HARDWRE	-	3207 BLACK FOAM GRIP .940" X 12"
1203	TRAPEZE RIG ADJ.PAIR W/O	-	3262 SPREADER BAR END COVER
1204	TRAPEZE RIG ADJ KIT DOUBL	-	5029 HAT, HOBIE FIRST CAST GRY/BLK
1263	UPRIGHT- H-16	-	5031 HAT, HOBIE FLYING H FLAT BILL
1264	UPRIGHT, H18/20	-	5032 HAT, HOBIE KAYAK
1265	UPRIGHT-H-17/SPORT	-	5034 HAT, HAVE A HOBIE DAY ORANGE
1266	RESCUE STEP - BOAT	-	5036 HAT, HOBIE FLYING H
1491	TAPE, ANTI-CHAFE H16/20	-	5039 HAT, FISH PATTERN BLUE/BLACK
1492	TAPE, ANTI-CHAFE H14/17	-	5040 HAT, HOBIE CLASSIC SURF NAVY
1493	TAPE, ANTI-CHAFE H18	-	5041 HAT, HOBIE CLASSIC DIAMOND NAV
1494	CHAFE TAPE 1" (BY THE FOOT)	-	5042 HAT, HOBIE LIFE GUARD
1510	SUPERGOOSE, TRENTEC	-	5043 HAT, HOBIE ECLIPSE
1511	GOOSENECK BEARING, TRENTEC	-	5044 HAT, HOBIE FISH PATTERN BLACK
1512	JIB PROTECTOR KIT-TRENTEC	-	5045 HAT, HOBIE CAMO REDFISH
1513	JIB PROTECTOR KIT, H20-TRENTEC	-	5046 HAT, HOBIE RED REDFISH
1528	BATTEN TENSIONER, LEACH	-	5047 HAT, HOBIE BASS PATCH
1529	BATTEN CAP, FOAM 3/4", H20, P1	-	5049 HAT, HOBIE DORADO
1541	DRAFT GAUGE, H14 TRENTEC	-	5050 HAT, HOBIE STRIPER
1543	DRAFT GAUGE, H18 TRENTEC	-	5051 RUDDER PIN, H14/16 FG (PAIR)
1544	KICK BACK KIT, TRENTEC	-	5052 RUDDER PIN H17/18 FG (PAIR)
1551	KNIFE, DLX STAINLESS	-	5054 HAT, HOBIE SAILING
1552	JIB CARS, H16-TRENTEC-PR.	-	5055 HAT, HOBIE AQUA H
1553	JIB CAR H16 EUROPEAN	-	5056 BEANIE, HOBIE BLACK
1561	LUFF CAP KIT H14 TRENTEC	-	5057 BEANIE, HOBIE GREY
1562	LUFF CAP KIT H16 TRENTEC	-	5107 SILICONE SPRAY 7oz
1563	LUFF CAP KIT H18 TRENTEC	-	5120 HOBIE MULTI LUBE 1 OZ
1566	BATTEN CAP H16 JIB LUFF	-	5121 HOBIE MULTI LUBE 4 OZ
1603	MAGICA RUST REMOVER GEL 8 OZ B	-	5201 RUDDER CAM SCREW,H14/16
1611	POLISH, STARBRITE MARINE	-	5202 RUDDER CAM KIT H14/16
1618	POLISH, FIBERGLASS COLOR	-	5203 RUDDER CAM SCREWS H17/18/20
1619	TRAMP CLEANER, SEASPRAY	-	5204 RUDDER CAM KIT H17/18/20
1620	END CAP CAT & TIGER TRAX	-	5401 CAT BAG 5" ORANGE
1621	CAT TRAX W/ 8' AXLE	OS	5402 CAT BAG 4"
1622	CAT TRAX W/8.5' AXLE H20	OS	5403 CAT BAG 6"
1623	CAT TRAX T-HANDLE	OS	5411 FAT BAG-5"
1624	CAT CRADLES, FITS ALL BOATS, C	-	5412 FAT BAG 4"
1625	WAVE BLUE TRAX	OS	5413 FAT BAG 6"
1626	BLUE TRAX W/ 8' AXLE	OS	5421 HATCH BAG KIT KAYAK
1630	CAT TRAX - WAVE 7' AXLE	OS	6000 HOBIE BEACH TOWEL-ORANGE
1635	CAT TRAX WHEEL ONLY REPL.	OS	6001 HOBIE BEACH TOWEL-LIME
1636	BLUE TRAX WHEEL ONLY REP	OS	6002 HOBIE BEACH TOWEL-YELLOW
1640	CAT TRAX REPLA. BEARINGS	-	6003 HOBIE BEACH TOWEL-AQUA
1641	CAT TRAX NYLON WASHERS	-	7003 MIRA ZYME 8 oz ODOR ELIMINATOR
1642	CAT TRAX S.S. WASHERS	-	7904 VELCRO ONE WRAP 1" BLACK
1643	CAT TRAX COTTER PINS	-	8001 ROLLER FURLER KIT,H16
1644	AXLE HOSE C.T. OR T.T.	-	8002 SAIL H16 JIB REC - WHITE
1645	AXLE, CAT TRAX 8' REPLACEMENT	OS	10049 QUICK RELEASE LEVER 1/4
1646	AXLE, CAT TRAX 8 1/2' REPLACEM	OS	10072 MINI BLOCK
1647	AXLE, TIGER TRAX 8' REPLACEMENT	OS	10075 SWV CAM CLEAT PLATE
1648	AXLE, TIGER TRAX WAVE 7' REPLA	OS	10076 DECK EYE
1662	TAPE, SAIL REPAIR 2"X 25' ROLL	-	10085 CONTOURED SPACER
1665	REPAIR KIT, SAIL	-	10091 YOKE FOR YOKE ASSEMBLY
1791	TIE DOWN, WAVE	-	10100 BUCKLE, SIDE-RELEASE 2"
1793	TIEDOWN H16 CUSTOM	-	13826 SPREADER BAR, HOBIE HARNESS
1794	TIEDOWN H18 CUSTOM	-	14709 TRAPEZE RIG RETURN SYSTEM
1795	TIE DOWN- ONE PIECE	-	16703 CONTACT CEMENT
1811	SNORKEL - H16/SPRT/18/21SC JIB	-	16706 RAIL KIT, H16 / H14 NEOPRENE
1812	SNORKEL - H1-14/H-14 TURBO JIB	-	16707 NEOPRENE RACE STRIPS
1813	SNORKEL - H18SX/20/21SE JIB	-	16708 RAIL KIT,H18 NEOPRENE
1815	SNORKEL - GETAWAY JIB	-	20301 PIN, QR 3/16 X 3/4 CUP
1953	TILLER CONNECTOR KIT	-	20302 PIN, QR 1/4 X 3/4 CUP
1954	TILLER CONNECTER KIT,WAVE	-	20303 PIN, QR 1/4 X 1-1/4 RING
1956	CLUB TILLER CONNECTOR KIT	-	20304 PIN, QR 1/4 X 1 RING
1957	TILLER CONNECTION KIT '07 ROTO	-	20305 PIN, QR 1/4 X 1 CUP
2001	DOG BONE, STD	-	20306 PIN, QR W/LANYD & SHACKLE
2002	DOG BONE, MODIFIED	-	20307 PIN, QR 1/4 X 1-1/2 CUP
2003	DOG BONE, FLEXIBLE	-	20310 QR WIRE KEEPER
2010	TRAP HANDLE, ALUMINUM	-	20311 PIN, QR 3/16 X 3/4 RING
2011	HANDLE TRAPEZE	-	20312 PIN, QR 1/4 X 3/4 RING
2061	GROMMET & TOOL KIT	-	20313 PIN, QR 3/16 X 1/2 RING
2062	GROMMETS #4 BRAS PKG. 24	-	20314 PIN, QR 1/4 X 1/2 RING
2064	TRAMP LACE KIT H14/16/18	-	20501 HAIRPIN COTTER 5/16" 302 SS
2065	TOOL, EASY RIG	-	20502 HAIRPIN COTTER 3/8" 302 SS
2066	TRAMP CLAMP, TRENTEC	-	20503 SAFETY PIN 1-9/16" LENGTH
2067	MAIN SHEET OVRBD.PREV.66"	-	20803 TOGGLE SNAP SHACKLE 2-3/4"
2069	TOOL, EASY RIG-MAXI	-	30101 EASY UP H14/16
2070	CLAMCLEAT TUG CLEAT	-	30102 RIGHTING SYSTEM,EASY UP - H18
2072	BOOM VANG EYE STRAP	-	30105 EASY RITE H14/16/17
2081	DOWNHAUL KIT H14/16	-	30106 EASY RITE H18/21
2082	SCALE - DOWN HAUL / FISH	-	30107 RIGHTING BUCKET
2089	DOWNHAUL KIT 6:1 H14/16	-	30108 EASY RITE H20
2090	HOBIE 14 "POWER PAK"	-	30109 EASY RITE GETAWAY- REPLACEMENT
2091	HOBIE 16 "POWER PAK"	-	30110 HYDROFOILS H14/16
2101	SHOCK CORD HOOK 1/4" - HOBIE	-	30112 MAST FLOAT KIT - MAMA UNIVERSA

INDEX

30115	MAST FLOAT KIT WW/H14/16 "BABY	-	72046	PADS ROOF RACK - 36"	-
30116	MAST FLOAT ATTACH H14/16	-	72049	PADS AERO BAR - 36"	-
30118	MAST FLOAT (30113) MNT PARTS	-	83102	TOOL GERBER MULTI-PLIER 600	-
30119	MAST FLOAT KIT "MAMA BOB" STD	-	83103	TOOL ALL PURPOSE	-
30120	MOUNT KIT ONLY - MAMA UNIVERSA	-	83104	TOOL, HOG RING PLIERS	-
30302	CLEVIS PIN SET WAVE/GTWY	-	83105	TOOL, CABLE CUTTER	-
30303	CLEVIS PIN SET H14/16	-	83106	TOOL, SWAGE-IT	-
30304	CLEVIS PIN SET H18	-	8000341	LOCTITE BLUE .5 ML CAPSULE	-
30305	SPARE PARTS KIT H14	-	8000432	MAST GLUE KIT- BOND CTIP TO MA	-
30306	SPARE PARTS KIT H16	-	8001821	HIKING STRAP, TRAMPS (PER YD)	-
30307	SPARE PARTS KIT H18	-	8001850	WEBBING 2" BLACK	-
30308	SPARE PARTS KIT WAVE/GTWY	-	8003500	GELCOAT 1/2 PT-WHITE	-
30311	CONVENIENCE KIT H16	-	8004301	LINE 3/16" POLYPRO-BLUE	-
30312	CONVENIENCE KIT H18	-	8004321	LINE 3/16" SGL BRAID-BLACK	-
30314	SPARE PARTS KIT H17	-	8004631	LINE DINGHY LIGHT 5/16"	-
30315	CONVENIENCE KIT H17	-	8004651	LINE DINGHY LIGHT 1/4"	-
30317	CLEVIS PIN SET H17/20	-	8004951	LINE JIB HLYD AMSTEELBLUE (TM)	-
30320	SPARE PARTS KIT H20	-	8005611	GELCOAT QUART-WHITE	-
50007	CAM CLEAT SW W/BULLSEYE	-	8006610	GELCOAT PUTTY-WHITE 1.25 OZ.	-
50009	SWIVEL CLEAT/H150/BUL EYE	-	8010020	RIVET 1/8 X 5/16, BRASS	-
50010	ADPTR PLATE W/HDWR FOR	-	8010051	RIVET 4-8 CSK ALUM	-
50012	ROLLER FAIRLEAD KIT	-	8010071	RIVET 3/16x 5/16 ALUM	-
50013	CAM CLEAT W/ROLLER	-	8010121	RIVET POP 3/16x5/8 PH-SS	-
50014	TRAVELER TAMER KIT	-	8010131	RIVET POP 3/16x3/8 PH-SS	-
50017	SWIVEL CAM CLEAT	-	8010151	RIVET, MASTHEAD SHEAVE SINGLE	-
65012	CALIF BLK MENS S/S T M	-	8010171	RIVET 3/16 x 5/8 CSK ALUM	-
65013	CALIF BLK MENS S/S T L	-	8010181	RIVET POP 3/16x1/4 PH	-
65014	CALIF BLK MENS S/S T XL	-	8010201	RIVET 3/16 X 3/8" CSK	-
65015	CALIF BLK MENS S/S T XXL	-	8010261	RIVET 3/16 x 3/16 SS	-
65022	CALIF CRM MENS S/S T M	-	8011101	RIVET SEMI 3/16 x 9/16 ALUM	-
65023	CALIF CRM MENS S/S T L	-	8011231	RIVET POP 3/16x1/2 PH	-
65024	CALIF CRM MENS S/S T XL	-	8011251	RIVET 3/16 x 1-1/8 PH-AL	-
65025	CALIF CRM MENS S/S T XXL	-	8011281	RIVET 1/4 X 1 RH SOLID-302 SS	-
65031	DIAMOND WHT MENS S/S T S	-	8011291	RIVET CAP	-
65032	DIAMOND WHT MENS S/S T M	-	8012062	RIVET SEMI 3/16x27/32 SS	-
65033	DIAMOND WHT MENS S/S T L	-	8020021	CLEVIS PIN 3/16x.453 GRIP	-
65034	DIAMOND WHT MENS S/S T XL	-	8020041	CLEVIS PIN 3/16x.570 GRIP	-
65035	DIAMOND WHT MENS S/S T XXL	-	8020051	CLEVIS PIN 3/16x.709 GRIP	-
65036	DIAMOND WHT MENS S/S T XXXL	-	8020061	CLEVIS PIN 3/16x.753 GRIP	-
65041	CLASSIC WHT MENS S/S T S	-	8020080	MAST STEP PIN, 3/16 X 2.125 SS	-
65042	CLASSIC WHT MENS S/S T M	-	8020101	CLEVIS PIN 5/16 x 2.032 GRIP	-
65043	CLASSIC WHT MENS S/S T L	-	8020181	QUICK PIN 1/4"x1-1/2"	-
65044	CLASSIC WHT MENS S/S T XL	-	8020340	CLEVIS PIN 3/16x1.062 GRP	-
65045	CLASSIC WHT MENS S/S T XXL	-	8020351	CLEVIS PIN 1/4x.3285 GRIP	-
65046	CLASSIC WHT MENS S/S T XXXL	-	8020361	CLEVIS PIN 1/4x.675 GRIP	-
65051	CLASSIC BLK MENS S/S T S	-	8020371	CLEVIS PIN 1/4x.469 GRIP	-
65052	CLASSIC BLK MENS S/S T M	-	8020381	CLEVIS PIN 1/4x.578 GRIP	-
65053	CLASSIC BLK MENS S/S T L	-	8020391	CLEVIS PIN 1/4x.8285 GRIP	-
65054	CLASSIC BLK MENS S/S T XL	-	8020411	CLEVIS PIN 1/4x1.0785 GRIP	-
65055	CLASSIC BLK MENS S/S T XXL	-	8020421	CLEVIS PIN 1/4x1.141 GRIP	-
65056	CLASSIC BLK MENS S/S T XXXL	-	8020431	CLEVIS PIN 1/4x1.328 GRIP	-
65061	DIAMOND BLK MENS S/S T S	-	8020451	DETENT RING PIN 1/4 X 2	-
65062	DIAMOND BLK MENS S/S T M	-	8020461	DETENT RING PIN 1/4" X 1-1/8"	-
65063	DIAMOND BLK MENS S/S T L	-	8020501	CLEVIS PIN, 1/4X3-1/2,MAST	-
65064	DIAMOND BLK MENS S/S T XL	-	8020601	CLEVIS PIN 5/16 X 1 3/8	-
65065	DIAMOND BLK MENS S/S T XXL	-	8030001	SCREW 12-24 X 1" PHMS-P SS	-
65066	DIAMOND BLK MENS S/S T XXXL	-	8030071	SCREW 10-32 X 1/2 FHMS	-
65072	SCRIPT AHGRY MENS L/S T M	-	8030111	SCREW 10-32 X 1 PHMS-P SS	-
65073	SCRIPT AHGRY MENS L/S T L	-	8030151	SCREW 10-32 x 1/2 PHMS-P SS	-
65074	SCRIPT AHGRY MENS L/S T XL	-	8030161	SCREW 10-32 X 1-1/2 PHMS-P SS	-
65075	SCRIPT AHGRY MENS L/S T XXL	-	8030171	SCREW 12-24 X 3/4 RHMS-P SS (	-
65082	SCRIPT CHAR MENS L/S T M	-	8030201	SCREW #10x1 FHMS-P SS	-
65083	SCRIPT CHAR MENS L/S T L	-	8030211	SCREW 1/4-20 X 1" RHMS-PH SS	-
65084	SCRIPT CHAR MENS L/S T XL	-	8030241	SCREW 10-32x1-1/2 FHMS-P	-
65085	SCRIPT CHAR MENS L/S T XXL	-	8030251	SCREW 10-32 X 1" FHMS	-
65091	SCRIPT CHARH PO HOODIE S	-	8030281	SCREW 10-32 X 3/4" RHMS-P SS	-
65092	SCRIPT CHARH PO HOODIE M	-	8030291	SCREW 5/16-18 X 2" PHMS-P SS	-
65093	SCRIPT CHARH PO HOODIE L	-	8030301	SCREW 5/16-18 X 1-1/4 RHMS SS	-
65094	SCRIPT CHARH PO HOODIE XL	-	8030311	SCREW 5/16-18x 1-1/2 RHMS	-
65095	SCRIPT CHARH PO HOODIE XXL	-	8030331	SCREW 1/4-20 X 5/8 PHMS-P SS	-
65111	SCRIPT OATH PO HOODIE S	-	8030361	SCREW 5/16-18 X 1-1/4 SOC HD	-
65112	SCRIPT OATH PO HOODIE M	-	8030401	GUIDGEON SCREW PKG OF 16	-
65113	SCRIPT OATH PO HOODIE L	-	8030402	SCREW 12-24x1 PH-LONG LOK*	-
65114	SCRIPT OATH PO HOODIE XL	-	8030501	SCREW 8-32 X 3/8" THMS-P SS	-
65115	SCRIPT OATH PO HOODIE XXL	-	8030601	SCREW 1/4-20 X 1-5/8 THMS	-
65121	SCRIPT BUORH PO HOODIE S	-	8030620	SCREW #10 X 1 3/4 PHMS-PSS	-
65122	SCRIPT BUORH PO HOODIE M	-	8030701	SCREW 1/4-20 X 1" THMS-P SS	-
65123	SCRIPT BUORH PO HOODIE L	-	8030711	SCREW 1/4-20 X 3/8 RHMS-P SS	-
65124	SCRIPT BUORH PO HOODIE XL	-	8030981	SCREW 10-32 x 3/4 PPHMS	-
65125	SCRIPT BUORH PO HOODIE XXL	-	8030991	SCREW 10-32 X 3/4" P-FHMS	-
65131	CALIF CHAR ZIP HOODIE S	-	8031011	SCREW 10-24 X 1-1/4" FHMS-S SS	-
65132	CALIF CHAR ZIP HOODIE M	-	8031031	SCREW 10-24 X 1-1/2" FHMS NYL	-
65133	CALIF CHAR ZIP HOODIE L	-	8031071	SCREW 10-32 X 1-1/4 PHMS-P	-
65134	CALIF CHAR ZIP HOODIE XL	-	8031131	SCREW #10x 3/4 PHSM-PH SS(ABA	-
65135	CALIF CHAR ZIP HOODIE XXL	-	8031151	SCREW #10 X 1/2 PHMS-P	-
65141	CALIF BUORH ZIP HOODIE S	-	8031191	SCREW 1/4-20 X 1-1/4"PHMS	-
65142	CALIF BUORH ZIP HOODIE M	-	8031231	SCREW 8-32 X 7/8" FHMS	-
65143	CALIF BUORH ZIP HOODIE L	-	8031501	SCREW 8 X 3/4" FHMS-P SS	-
65144	CALIF BUORH ZIP HOODIE XL	-	8031511	SCREW 8 X 1 FHMS	-
65145	CALIF BUORH ZIP HOODIE XXL	-	8031541	SCREW 8 X 3/4" PHMS-P SS	-
65151	CALIF OATH ZIP HOODIE S	-	8031731	SCREW 8 X 1 PHMS-P SS	-
65152	CALIF OATH ZIP HOODIE M	-	8031771	SCREW 5/16-18 X 7/8 SOC HD-CAP	-
65153	CALIF OATH ZIP HOODIE L	-	8031810	STUD 5/16-18 X 1-1/4" 18-8 SS	-
65154	CALIF OATH ZIP HOODIE XL	-	8031821	SCREW 5/16-24 X 2 SKT SET *	-
65155	CALIF OATH ZIP HOODIE XXL	-	8031891	SCREW #14 X 3/4 P-PHMS	-
65171	FLYING H HWHT L/S SCOOP T S	-	8031950	SCREW #10 X 5/8 FHMS-P SS	-
65172	FLYING H HWHT L/S SCOOP T M	-	8032001	SCREW 3/8-16 X 3/4 DELRIN	-
65173	FLYING H HWHT L/S SCOOP T L	-	8032011	SCREW 1/4-20x1/2 RHMS-P SS	-
65174	FLYING H HWHT L/S SCOOP T XL	-	8032061	SCREW 1/4-20x1 1/4 PPHMS	-
65181	FLYING H VBLK L/S SCOOP T S	-	8032091	SCREW 3/8-16 x1/2 NYLON PHMS-S	-
65182	FLYING H VBLK L/S SCOOP T M	-	8032121	SCREW #10 x 1 PHMS-P TF-12	-
65183	FLYING H VBLK L/S SCOOP T L	-	8032211	SCREW 10-32 X 2-1/2 PHMS	-
65184	FLYING H VBLK L/S SCOOP T XL	-	8032221	SCREW 5/16-18x2-1/2 SOC-HD CAP	-
72010	KEY FLOAT/SCUPPER PLUG	-	8032401	SCREW 10-24x1/4 PHMS-P SS	-
72040	QUICK STRAP RACK W/TIE DN	-	8040001	BOLT 1/4-20x1 1/2	-
72041	MULTI STRAP SYSTEM	-	8040011	BOLT 1/4-20 X 1-3/4 HX HD SS	-
72044	PADS AERO BAR - 24"	-	8040021	BOLT 1/4-20 X 7/8 HX HD SS	-
72045	PADS ROOF RACK - 24"	-	8040022	BOLT 1/4-20 X 2 HX HD C/S SS	-

INDEX Continued...

8040051	BOLT 1/4-20 X 3" HEX HD SS	-	10400010	TILLER END CAP	-
8040061	BOLT 3/8-16 X 5"	-	10412011	LWR RDR CSTG H14/16 BLK	-
8040081	BOLT, 5/16-18 X 3/4"	-	10430000	SPRING RUDDER CASTING	-
8040111	BOLT 1/4-20 X 5 HEXCAP	-	10432000	SPRING H16 LWR CASTING	-
8040131	BOLT 1/4-20 X 3 1/2	-	10440000	PLUNGER, RUDDER H14/16	-
8040171	BOLT 5/16-18 X 1 HEX HD SS	-	10470000	PIN RUDDER CASTING	-
8040211	BOLT 5/16-18 X 4-1/2 HHCS SS	-	10480000	CAM	-
8040291	BOLT, 5/16-18 X 3/4	-	10520011	TILLER XBAR H14 BLACK	OS
8040301	BOLT 5/16-18 X 1-1/4 SS	-	10532010	TILLER EXTENTION HINGE	-
8040321	BOLT 5/16-18 X 2-1/2" HX HD	-	10532020	TILLER EXTENTION YOKE	-
8040331	BOLT 5/16-18 X 2" HX HD	-	10560000	CAP-ROUND POLYETHYLENE, BLACK	-
8040341	BOLT 5/16-18 X 2-3/8 HEX SS	-	10581100	MAST ASSY H14 BLACK	-
8040361	BOLT 3/8-16 X 3-1/2" HX HD	-	10582100	COMPTIP H14	OS
8040371	BOLT 5/16-18 X 3 7/16	-	10602111	MAST HEAD, H14 COMPTIP	-
8040381	BOLT 5/16-18 X 3-3/4	-	10620000	SHEAVE, H14 MAST HEAD	-
8040391	BOLT 5/16-18 X 2-3/4" HX HD	-	10640011	MAST BASE H14/WV BLACK	-
8040501	BOLT 3/8-16 X 2"	-	10651001	HALYARD - H14 (NON COMPTIP)	-
8040521	BOLT 3/8-16 X 2-1/2 SCK H	-	10657001	HALYARD - H14 (COMPTIP)	-
8040561	BOLT 3/8-16 X 3-3/4 SOCHD	-	10670000	SHACKLE, HALYARD	-
8040600	SCREW 3/8-16 X 4" PHMS-P	-	10680000	HOOK, HALYARD (12 GA)	-
8040731	BOLT 1/2-13 X 3-5/8" SS*	-	10690000	MAST TANG H14/WV	-
8041111	BOLT 1/4-20x2-3/4 HX HD MS-SS	-	10700000	SHACKLE "BOW" 6.4 MM	-
8050101	NUT 1/4-20 NYLOCK LOPRO	-	10720011	BOOM H14 BLACK	OS
8050111	NUT 1/4-20 HX NYLOCK	-	10730000	CLEAT-MAST	-
8050121	NUT 1/4-20 CNTRLOCK SS	-	10740011	BOOM CAP, H14/16/21SC FWD	-
8050151	NUT 5/8-18 HEX FIN JAM SS	-	10741031	BOOM CAP, H14/16 AFT BLACK	-
8050201	NUT 10-32 HEX NYLOCK	-	10760000	BLOCK HANGER	-
8050211	NUT 10-32 NYLOCK LOPRO	-	10770001	GOOSENECK ASSY H-14, 16	-
8050300	NUT 5/16-18 HEX THIN JAM	-	10772001	GOOSENECK SLIDE	-
8050301	NUT 5/16-18 NYLON	-	10772010	GNECK BOOM PIN (WRL PIN)	-
8050311	NUT 5/16-18 NYLOCK STD	-	10772020	GOOSENECK SHACKLE	-
8050331	NUT 5/16-18 HX NYLOCK LP	-	10772070	GOOSENECK DOWNHAUL RING	-
8050341	NUT 5/16-24 NYLOCK LOPRO	-	10792100	WIRE SHROUD H14 BLACK	-
8050421	NUT #12-24 NYLOCK, HEX	-	10810010	WIRE FORESTAY H14T UPPER	-
8050461	NUT 9/16-18 HX JAM LP SS	-	10812101	WIRE FORESTAY H14 BLACK	-
8050511	NUT 3/8-24 NYLOCK HEAVY	-	10822010	WIRE BRIDLE H14 TURBO BLK	-
8050521	NUT 3/8-16 NYLOCK	-	10822101	WIRE BRIDLE H14 BLACK	-
8050540	NUT 3/8-16 HX NYLOCK-LP	-	10860001	LOCK RING 3/16"	-
8050601	NUT 1/2-13 NYLON HEX FIN	-	10860100	LOCK RING 3/16" - 100 PACK	-
8050611	NUT 1/2-20 NYLOCK LOPRO	-	10870000	SHACKLE "BOW" 4.7 MM	-
8050631	NUT 1/2-13 NYLOCK LO-PRO SS	-	10881000	RUDDER PIN H14, NYLON	-
8050801	NUT 8-32 MACH/SCREW SS	-	10970000	TRAMP SET H14 WHITE	-
8051301	NUT 10-32 SQUARE SS	-	10970055	TRAMP SET H14 BLACK MESH	-
8060001	COTTER PIN 1/16 X 1/2 SS	-	10970058	TRAMP SET H14 TURQ MESH	-
8060101	COTTER PIN 3/32 X 1/2 SS	-	10990010	SAIL H14 MAIN WHITE	-
8060111	COTTER PIN 3/32 X 3/4 SS	-	10990099	SAIL H14 MAIN - CUSTOM	-
8060121	COTTER PIN 3/32 X 2 SS	-	10991086	SAIL H14 MAIN CORONADO '08	-
8060151	RETAINING CLIP, "E" TYPE	-	10992081	SAIL H14 JIB TURQUIOSE	-
8061011	NYLINER 3/8 D X 3/8 L	-	10992511	SAIL H14 JIB WHITE	-
8061101	NYLINER 1" ID X 1.094 LG	-	11070000	BLOCK, H16 JIB HALYARD	-
8062001	BUSHING, RUDDER CSTG PKG OF 4	-	11110005	MAST BEARING, PKG OF 3	-
8062501	RING, RETAINING DARBY #1400-10	-	11110100	MAST BEARING, PKG OF 100	-
8062511	RING, RETAINER, DARBY 1400-143	-	11140011	TURBO STRIKER CASTING *	-
8062521	RING, RETAINER	-	11170000	DOLPHIN STRIKER-WIRE H14	-
8063001	SLEEVE NICROPRESS 1/16"	-	11170030	DOLPHIN STRIKER ROD H14	-
8063271	SLEEVE STOP 3/32 WIRE	-	11220000	SHACKLE STND "D" 4.7 MM	-
8063281	SLEEVE, STOP 1/8-COPPER	-	11322011	BATTEN CAP-LUFF	-
8063501	SLEEVE NICROPRESS 1/8"	-	11323000	BATTEN CAP-LEACH (2 holes)	-
8063751	SLEEVE NICROPRESS 5/32"	-	11470000	DEAD EYE	-
8063761	SLEEVE, NICROPRESS 3/32" *	-	11510000	TILLER CONN. HALF SPHERE	-
8063801	SLEEVE, NICOPRESS STOP	-	11520005	TILLER CONNECTOR KIT	-
8080011	WASHER, STAR LOCK, 8 EXT	-	11540000	TILLER CONNECTOR, SPRING	-
8080021	WASHER, STAR LOCK, 12 INT.	-	11720000	BOOK, LEARN TO SAIL-HOBIE	-
8080101	WASHER 1/4 X 1/2" LOCK	-	11810011	PLATE MAIN TRAV TRK RETRO	-
8080181	WASHER 5/16 X 9/16 FLAT	-	11840100	TRAVELER HINGE	-
8080481	WASHER 5/16 SPRING	-	11850000	TRAVELER, HINGE WIRE	-
8080511	WASHER .250x.500x.063 SS	-	11860000	TRAVELER SPACER	-
8080551	WASHER-FLAT .227 X .453 SS	-	11870000	TRAVELER, DECK PLATE	-
8080561	WASHER 1/4 X 1/2 X .032 SS	-	11880000	TRAVELER SHEAVE	-
8080571	WASHER FLAT 1/4x3/4x.063 SS	-	11901010	PAD FOR 240/241 SWVL BASE	-
8080581	WASHER 3/8" HC SPLIT-LOCK	-	11952021	FAIRLEAD REPLACEMENT KIT	-
8080611	WASHER FLAT 3/8 X 3/4 SS	-	12240000	TACK/CLEW PLATE SET	-
8080622	WASHER 1/2" SPLIT TRIFOIL TF-2	-	12430001	DECAL, SAIL HOBIE "H"-WHT	-
8080631	WASHER 3/8 X 1 X .062 NYL TRIF	-	12430011	DECAL HOBIE SAIL "H" BLACK	-
8080671	WASHER 5/16 X 3/4 FLAT SS	-	12440000	DECAL, SAIL H14	-
8080681	WASHER 5/16 X 1/2 X .030 NYLON	-	12450015	DECAL SET, BRAVO/WAVE CURLS	-
8080691	WASHER 3/8 X 3/4 NYLON-FLAT	-	12450016	DECAL BRAVO	-
8080701	WASHER 1/4 X 1 SS HP	-	12450017	DECAL WAVE	-
8080711	WASHER 5/8 X 1-5/16 SS	-	12451031	DECAL "HOBIE" DIAMOND-TURQ/SLV	-
8080891	WASHER 11/16 X 5/16 X .065 SS	-	12451050	DECAL "HOBIE" SCRIPT BLACK	-
8080901	WASHER 1/4 X 3/4 FLAT-NEOPRENE	-	12451051	DECAL "HOBIE" SCRIPT WHT	-
8081011	WASHER 5/8 X 1" NYLON	-	12451061	DECAL "HOBIE" DIAMOND-SLVR/GRA	-
8090900	COMPTIP CAPLUG	-	12451130	DECAL "HOBIE CAT" RED	-
10060000	PLUG, MAST & PYLON	-	12452000	STRIPE 3/16" SILVER	-
10091000	DRAIN PLUG W/GASKET	-	12452121	DECAL HOBIE CAT 16 (BLK/SLVR)	-
10092000	DRAIN PLUG HOUSING	-	12452161	DECAL "16" SLVR	-
10092010	DRAIN PLUG-EACH	-	12453023	DECAL, HOBIE SCRIPT CHROME/BLK	-
10092025	GASKET-BLACK RUBBER	-	12453024	DECAL, 12" HOBIE FISHING BLACK	-
10092100	DRAIN PLUGS-PKG 100	-	12453026	DECAL 12" HOBIE SAILING BL/RD/	-
10092120	DRAIN PLUG GASKET-PKG/100	-	12453031	DECAL - HOBIE CAT TEQ	-
10131910	CROSS BAR H14 FWD BLACK	OS	12480000	MAIN BATTEN POCKET PROTECTOR (	-
10140000	PYLON VENT TUBE	-	12480001	HOBIE POCKET PROTECTOR KIT	-
10152011	CORNER CSTG H16 RACE L/R #1	-	12700030	SAIL NUMBER 14" #0 BLACK	-
10162011	CORNER CSTG H16 RACE R/F #2	-	12710030	SAIL NUMBER 14" #1 BLACK	-
10170011	MAST STEP H14/WV BLACK	-	12720030	SAIL NUMBER 14" #2 BLACK	-
10191910	X-BAR H14 AFT W/O CAST BK (INT	OS	12730030	SAIL NUMBER 14" #3 BLK.	-
10202011	CORNER CSTG H16 RACE R/R #3	-	12740030	SAIL NUMBER 14" #4 BLK.	-
10212011	CORNER CSTG H16 RACE L/R #4	-	12750030	SAIL NUMBER 14" #5 BLK.	-
10261000	CLEAT, STNLS V-JAMMING	-	12760030	SAIL NUMBER 14" #6/9 BLK.	-
10262000	CLEAT, BARREL	-	12770030	SAIL NUMBER 14" #7 BLK.	-
10270011	SIDEBAR H14 LEFT BLACK	OS	12780030	SAIL NUMBER 14" #8 BLACK	-
10280011	SIDEBAR H14 RIGHT BLACK	OS	13001001	DECAL BOW - FLYING "H" BLK	-
10300000	CHAIN PLATE, "TURBO"	-	13440000	DECAL, MAST CAUTION. BLK	-
10311900	RUDDER LOCKING KIT H14/16	-	13440010	DECAL, MAST CAUTION/ORNG	-
10352011	UPR RDR CSTG H14/16 LEFT	-	13450000	ASSEMBLY MANUAL H14	-
10362011	UPR RDR CSTG H14/16 RIGHT	-	13780000	TRAMP LACE STRIP H14/16 WHITE	-
10382010	TILLER ARM H14 STRGHT BLK	-	13780055	TRAMP LACE STRIP H14/16 BLACK	-

INDEX

20060000	MAST FOAM PLUG - H16	-	30690001	TANG FOR SHROUD,H21/SC/20	-
20100000	ANCHOR PIN	-	30691001	TANG FOR REACHER,H21/21SC	-
20120000	BOW TANG H14/16	-	30740001	RUDDER PIN H21/SC	-
20132031	SHEAVE H16 JIB TRAV	-	31110001	COMPRESSION SLEEVE,H21/SC	-
20140001	DOLPH STRIKER,POST H16/14	-	31210001	MAST ROTATION BAR 17/21	-
20170001	DOLPHIN STRIKER ROD H16	OS	31800001	TRAVELER CAR ASSY H20/21SC	-
20200011	MAST STEP,H14/16 BLACK	-	32331001	HEADBOARD H20/21 MAIN	-
20210000	TWIST TOGGLE	-	36601000	DECAL FLYING "H" SMALL BLK	-
20240001	BLOCK H16/18 JIB HALYARD	-	36601011	DECAL FLYING "H" SMALL WHT	-
20250000	TRACK - H16 JIBSHEET BLOCK	-	36970000	TRAMP SET H21C MAIN - WHITE	-
20260000	TRACK END CAP 5/8"	-	36980055	TRAMP H21SC FWD-BLACK MESH	-
20270011	SIDE BAR H16 BLACK	OS	36991991	SAIL H21SC MAIN - CUSTOM	OS
20352000	RUDDER CAM STOP PLATE	-	36992991	SAIL H21C JIB - CUSTOM	OS
20382011	TILLER ARM H16 STR BLACK	-	37001000	WING SET GETAWAY W/COVER T/F	OS
20400001	BATTEN SET H16 JIB	OS	37001010	WING SET GTWY W/COVER 17+	OS
20490030	RUDDER BLADE EPO-3	-	37016001	BATTEN SET GETAWAY	OS
20491000	RUDDER BLADE EZ LOC w/INDENTS	-	37091001	WING TENSION LEG GETAWAY	-
20492021	EZ LOC PLUNGER - LWR RDR HOUSI	-	37101001	WING LEG GTWY	-
20493000	RUDDER BLADE - WHITE NYLON	-	37131710	X-BAR GETAWAY FWD ASSY 17+	OS
20520011	TILLER XBAR H16/17/18 BLK	OS	37131910	X-BAR GETAWAY FWD ASSY	OS
20521001	TILLER XBAR H16/17/18 '95	OS	37140001	TRAPEZE RIG KIT GETAWAY	-
20550001	TILLER EXTENSION H14/16 (84")	OS	37151041	END CAP FWD XBAR CSTG PIS GTWY	-
20610000	MAST ASSY H16 BLACK	OS	37170001	STUD MAST STEP GETAWAY	-
20611100	COMPTIP H16	OS	37191710	X-BAR GETAWAY AFT ASSY 17+	OS
20614001	MAST HEAD H16 COMPTIP	-	37191910	X-BAR GETAWAY AFT ASSY	OS
20614210	SHEAVE 2-1/4" OD BLACK DELRIN	-	37201021	CSTG AFT XBAR END CAP GETAWAY	-
20614231	SPACER MSTD SHEAVE-16	-	37312000	GETAWAY EZ LOC RUDDER ASSY - A	OS
20616001	LUFF TRACK 92-7/8"-H16	OS	37321111	TILLER ARM GETAWAY	-
20617001	HALYARD - H16 MAIN (COMPTIP)	-	37341011	TRAMP TRACK MAIN GETAWAY	OS
20640011	MAST BASE H16 BLACK	-	37342011	TRAMP TRCK FWD GETAWAY	OS
20651011	HALYARD - H16 MAIN (NON COMPTI	-	37370031	GASKET COOLER COVER MOUNT	-
20661001	WIRE JIB HALYARD ASSY H16	-	37370036	TUBE FITTING, NYLON MULTI-BARB	-
20680000	SHEET BLOCK	-	37371038	PLUG ASSY - GETAWAY COOLER	-
20690000	MAST TANG H16/17/18	-	37380001	CLAMCLEAT MINI CL204	-
20700001	SHACKLE BOW 5/16 PIN	-	37382011	TILLER ARM GETAWAY EZLOC	-
20710000	BLOCK, H16 MAST CHEEK	-	37440150	DECAL GETAWAY HULL SET	-
20720011	BOOM H16 BLACK	OS	37440151	DECAL 'GETAWAY' 2005-2012	-
20730001	TRAPEZE SHOCKCORD H14/16	-	37450011	ASSEMBLY MANUAL GETAWAY	-
20730002	TRAP SHCKCD W/HOOK H14/16	-	37500001	BOW SPREADER GETAWAY	OS
20742001	WIRE H16 TRAPEZE W/ BLOCK (EA)	-	37500021	PLATE GTWY BOW SPRDR	-
20760000	THIMBLE 5/32"	-	37500031	END BLOCK GTWY BOW SPRDR	-
20781001	LINE PKG, H16	-	37501701	BOW SPREADER GETAWAY 17+	OS
20782001	MAINSHEET H16 44' 5/16" DINGH	-	37521001	TILLER XBAR GTWY - M20/ALUM CA	OS
20782002	JIBSHEET H16 32' 1/4" DINGHY L	-	37521701	TILLER XBAR GTWY EZ LOC 17+	OS
20790011	WIRE SHROUD H16/17/SPT WHT	-	37522001	TILLER XBAR GTWY - TENDON/ALUM	OS
20792011	WIRE SHROUD H16/17/SPT BLK	-	37523001	TILLER XBAR GTWY - TENDON/EZ L	OS
20800000	THIMBLE 1/8"	-	37524001	TILLER XBAR GTWY - '07/EZ LOC	OS
20810011	WIRE FORESTAY H16 UPR	-	37561001	TILLER END CAP (TENDON STYLE)	-
20810021	WIRE FORESTAY H16 LWR BAR	-	37561011	TENDON GTWY/WV - KIT	-
20810031	WIRE FORESTAY - H16 AUSSIE	-	37561200	TLR END CAP, w/HOLE (UAI)	-
20810041	WIRE FORESTAY UPPER - H16 AUS	-	37561203	TLR END CAP, PIN ASSY (UAI)	-
20811011	WIRE FORESTAY H16 LWR WHT	-	37583141	MAST GETAWAY LOWER T/F	OS
20812011	WIRE FORESTAY H16 LWR BLK	-	37601001	MAST HEAD ASSY GTWY	-
20820011	WIRE BRIDLE H16 WHITE	-	37610000	MAST ASSY GETAWAY	OS
20822011	WIRE BRIDLE H16 BLACK	-	37611001	SHEAVE GTWY MAST HEAD	-
20830010	ADJUSTER 1/4" 7 HOLE - SHROUD/	-	37611100	COMPTIP GETAWAY	OS
20830020	ADJUSTER 1/4" 10 HOLE - SHROUD	-	37611151	LUFF TRACK GTWY 102.0"	OS
20840000	SAILMAKERS THIMBLE 5/32	-	37641001	MAST BASE CSTG GETAWAY	-
20860000	LARGE CLEVIS RING	-	37651001	HALYARD MAIN GETAWAY	-
20860021	CLEVIS RING - WAVE SE SHROUD	-	37660031	WING END CAP L/F/R GTWY	-
20860100	LARGE CLEVIS RING / 100 PACK	-	37660041	WING END CAP R/F/LR GTWY	-
20880001	RUDDER PIN ALUM - H14/16	-	37661050	BRACKET WING LEG	-
20880011	RUDDER PIN S.STEEL - H14/16	-	37661091	LANYARD GTWY WING LEG	-
20970000	TRAMP SET H16 WHITE	-	37760041	CAM CLEAT PLT- GTWY (BENT)	-
20970055	TRAMP SET H16 BLACK MESH	-	37790001	WIRE SHROUD GETAWAY	-
20970058	TRAMP SET H16 TURQ MESH	-	37810001	WIRE FORESTAY ASSY GETAWAY	-
20970059	TRAMP SET H16 GRAY MESH	-	37810021	WIRE FORESTAY LWR GETAWAY	-
20991011	SAIL H16 MAIN WHITE	-	37810030	YOKE GETAWAY FORESTAY	-
20991085	SAIL H16 MAIN SMOKE '08	-	37822011	WIRE BRIDLE GETAWAY	-
20991086	SAIL H16 MAIN CORONADO '08	-	37830020	FORESTAY ADJ. 1/4" 10 HOLE GT	-
20991087	SAIL H16 MAIN HOT TAMALE	-	37880001	LACING ROD GTWY FWD 68.0"	OS
20991088	SAIL H16 MAIN SEABREEZE	-	37880011	LACING ROD GTWY MAIN 64-3/4"	-
20991991	SAIL H16 MAIN - CUSTOM	-	37900011	BLOCK RATCHET LWR GTWY	-
20992010	SAIL H16 JIB WHITE	-	37900021	BLOCK DOUBLE SWVL w/BKT GTWY	-
20992071	SAIL H16 JIB TURQUOISE	-	37970055	TRAMP GETAWAY BLACK MESH	-
20992081	SAIL H16 JIB SILVER	-	37970058	TRAMP GETAWAY TURQ MESH	-
20992086	SAIL H16 JIB RED '08	-	37971058	WING COVER GETAWAY TURQ MSH PR	-
20992088	SAIL H16 JIB SEABREEZE	-	37971758	TRAMP GETAWAY GRAY MESH 17+	-
20992310	SAIL H16 JIB WHITE - VELCRO RA	-	37977058	WING COVER GTW GRAY MSH PR 17+	-
20992386	SAIL H16 JIB RED - VELCRO RACE	-	37980055	TRAMP GETAWAY FWD BLACK MESH	-
20992388	SAIL H16 JIB SEABREEZE - VELCR	-	37981755	TRAMP GETAWAY FWD BLK MESH 17+	-
20992991	SAIL H16 JIB - CUSTOM	-	37991001	SAIL GETAWAY MAIN "H" WHT RESO	-
20999020	SPIN KIT H16 / GTWY SNUFFER, P	OS	37991076	SAIL GETAWAY MAIN "V" SEABREEZ	-
20999201	GENNAKER KIT - H16 WHITE	-	37991099	SAIL GETAWAY MAIN "V" CUSTOM	-
20999210	GENNAKER - H16 WHITE	-	37991176	SAIL GETAWAY MAIN "H" SEABREEZ	-
21000001	BATTEN SET H16 MAIN	OS	37991199	SAIL GETAWAY MAIN "H" CUSTOM	-
21090001	MAST SEAL PLATE,H16	-	37992071	SAIL GETAWAY JIB TURQUOISE	-
21180000	HOG RING 1/2" S/S, BLUNT, 14 G	-	37992099	SAIL GETAWAY JIB - CUSTOM	-
21180010	HOG RING 5/8" SS,BLUNT, 14 GA	-	38010061	SEAT PAD LT BLUE	-
21230000	CAR JIBSHEET W/BLOCK H16	-	38010071	SEAT PAD GRAY	-
21310000	BAG SAIL & BOOM STANDARD	-	38016001	BATTEN SET WAVE	OS
21333000	BATTEN CAP JIB-SINGLE	-	38040011	BACKREST SET WAVE - BLUE	OS
21380001	MAST STEP LINK KIT H14/16	-	38040012	BACKREST SET WAVE - GRAY	OS
21900030	BRIDLE WIRE H16 ROLLER FUR	-	38041001	COVER - BACKREST PAD BLUE (1)	-
22080905	LUFF BATTEN PROTECTOR KIT- JIB	-	38041002	COVER - BACKREST PAD GRAY (1)	-
22090001	JIB HANK W/ SCREW	-	38101301	PINTLE WAVE UPPER	-
22240000	JIB CLEW PLATE (5 HOLE)	-	38101401	PINTLE WAVE LOWER	-
22330000	DECAL SAIL - H16 CLASS INSIGNI	-	38120011	EYESTRAP WAVE BRIDLE	-
23450000	ASSEMBLY MANUAL H16	-	38120031	NYLON PUSH-IN PANEL RIVET	-
25131910	X-BAR H16 FWD W/STEP	OS	38120041	TANG HW BOW SPREADER	-
25191911	X-BAR H16 AFT	OS	38131041	X-BAR WAVE CLB/SE FWD NEW STEP	OS
25231051	JIB CAR STOP H16 (INT TRACK)	-	38132001	CROSS BAR STOP WAVE	-
25232201	JIB TRAV CAR LT - BRASS WHEELS	-	38140001	TRAPEZE RIGGING KIT WAVE	-
25232211	JIB TRAV CAR RT - BRASS WHEELS	-	38170001	STUD HW MAST STEP	-
25243003	JIB CAR SLIDE-ONLY W/ WHEELS	-	38171001	MAST STEP,HW (BALL STYLE)	-
25244001	JIB CAR - PLATE ONLY	-	38190021	END CAP AFT WAVE BLACK	-
30110001	MAST STEP BALL-GTWY/20/21	-	38191031	CROSS BAR WAVE AFT	OS

INDEX Continued...

38191041	SEAL CAP-BLACK 5/8"	-	40721001	BOOM ASSY H20	OS
38321111	TILLER ARM, WAVE ORIGINAL STYL	-	40741021	BOOM CAP H20 FWD	-
38360001	BUSHING WAVE LWR PINTLE	-	40760001	BLOCK HANGER, H20	-
38370001	HULL SEAL CAP (UNDER SEATPAD)	-	40770001	GOOSENECK PIN	-
38450000	ASSEMBLY MANUAL WAVE	-	40792001	WIRE SHROUD H20	-
38490011	KEEPER PIN WILANYARD WAVE	-	40810011	WIRE FORESTAY H20 UP	-
38581041	MAST ASSY WAVE 2-PC T/F	OS	40822001	WIRE BRIDLE H20	-
38582100	COMPTIP WAVE	OS	40822121	WIRE FORESTAY H20 (5/16" END)	-
38583141	MAST WAVE LOWER, NEWER TYPE T/	OS	40880011	RUDDER PIN H20 SS	-
38584001	LUFFTRACK 87.0"-HW-EXCPT H16 /	OS	40960005	WIRE BARBER HAULER H20	-
38641001	MAST BASE CSTG WAVE /FOR BALL	-	40970001	HIKING STRAP SET - H20	-
38650031	MAST CRADLE, WAVE AFT	-	40970055	TRAMP H20 BLACK MESH	-
38650041	MAST CRADLE, WAVE SET	-	40991000	SAIL H20 MAIN WHITE	OS
38651000	TRAILER ALUM HOBBIE WAVE/BRAVO	OS	40992010	SAIL H20 JIB WHITE	OS
38651001	HALYARD, WAVE MAIN	-	41010001	PLATE FWD INBOARD SUPPORT	-
38651100	MAST STAND ALUMINUM FORWARD	OS	41150001	FWD OUTBOARD SUPPORT TUBE H20	-
38651200	MAST STAND ALUMINUM REAR*	OS	41162001	HINGE/COVER PLATE H20 JIB	-
38653000	TRAILER ALUM HOBBIE 16-20"	OS	41170001	DOLPHIN STRIKER ROD H20	OS
38653100	DOUBLE ROLLER KIT - TRAILER AL	-	41190001	AFT XBAR SUPPORT TUBE 20/21SC	-
38653200	CRADLE MOUNT KIT - TRAILER ALU	-	41200001	MOUNT BRACKET H20 AFT #1	-
38660011	BACKREST COLLAR FWD WAVE	-	41220001	EYELET POST	-
38660031	BACKREST COLLAR AFT WAVE	-	41321001	TRAMP TRACK H20	OS
38670011	S HOOK,WAVE HALYD DWNHL	-	41330031	JIB CAR W/O SLIDE STBD	-
38760021	TUBE SE WAVE TRAMPOLINE	-	41330041	JIB CAR W/O SLIDE PORT	-
38760031	TRAMP ANCHOR HOOK SE WAVE	-	41340001	DAGGERWELL CARPET KIT H20 (2)	-
38760041	CAM CLEAT PLT-CLUB/SE	-	41370001	HATCH SCREW-IN W/LIP-WHT 5"	-
38760061	TENSION HOOK WAVE SE TRAMP	-	41400001	SPREADER ROOT AFT	-
38760071	HOOK WAVE SE TRAMP (SLIDE)	-	41410001	SPREADER TIP M20	-
38790001	WIRE SHROUD SE WAVE W/HOOKS	-	41420001	SPREADER ARM	-
38822011	WIRE BRIDLE WAVE SE W/HOOK-1/8	-	41430001	SPREADER BRACE	-
38870001	CRADLES STACKING WAVE SET 4	-	41440001	SPREADER SLIDE	-
38881011	TRAMP LACING ROD WAVE	OS	41450001	SHIELD PLATE - TURNBUCKLE M20	-
38900031	S HOOK, WAVE MAIN SHEET	-	41460001	TURNBUCKLE H20	-
38900061	BLOCK, STD FIDDLE W/BEARING	-	41661001	WIRE JIB HALYARD ASSY H20	-
38900071	BLOCK, 40MM FIDDLE W/CAM, BKT,	-	41750001	WIRE DIAMOND ASSY H20	-
38950011	END CAP WAVE, JIB SPREADER	-	41820001	BRIDLE CONNECTOR PLATE	-
38970000	TRAMP SET WAVE SE WHITE	-	41830001	JIB TACK PLATE	-
38970051	WIRE WAVE SE TRAMP	-	41880001	TOGGLE H20 JIB HLYD SWVL	-
38970055	TRAMP WAVE SE BLACK MESH	-	41881011	TRAMP LACE ROD H20/H21SC 72"	OS
38970058	TRAMP WAVE SE TURQ MESH	-	41890001	PIN SWIVEL 3/16	-
38970061	STRAP WAVE SE TRAMP AFT TENSIO	-	42000001	BATTEN SET H20	OS
38990050	SAIL BAG WAVE	-	42011011	BATTEN H20 #1 (97.0")	OS
38991000	SAIL WAVE MAIN "V" WHITE	OS	42021011	BATTEN H20 #2 (97.0")	OS
38991050	SAIL WAVE MAIN "H" WHITE RESOR	OS	42031011	BATTEN H20 #3 (93-1/2")	OS
38991077	SAIL WAVE MAIN "V" SEABREEZE	OS	42041011	BATTEN H20 #4 (87")	OS
38991078	SAIL WAVE MAIN "V" SEABREEZE W	OS	42051011	BATTEN H20 #5 (76")	OS
38991088	SAIL WAVE MAIN "H" SEABREEZE	OS	42061011	BATTEN H20 #6 (60")	OS
38991950	SAIL WAVE MAIN "H" CUSTOM RESO	OS	42071011	BATTEN H20 #7 (47")	-
38991991	SAIL WAVE MAIN "V" - CUSTOM	OS	42081011	BATTEN H20 #8 (31")	-
38992007	SAIL WAVE JIB YELLOW 25sq ft	-	43450001	ASSEMBLY MANUAL-H20	-
38992010	SAIL WAVE JIB WHITE (25 sq ft)	-	47070041	CL236 CLAMCLEAT RACING JR	-
38992071	SAIL WAVE JIB TURQUOISE (25 sq	-	48010001	HULL CRADLES FOR BEACH	-
38999000	SPIN POLE & HRDWR KIT WAV	-	48661001	WIRE JIB HALYARD H20 FURL	-
38999001	WAVE JIB SPDR & HRDWR KIT	OS	48814001	WIRE FORESTAY - FURLER H20	-
38999021	BOW SPREADER - WAVE	OS	48921001	ROLLER FURLER KIT H20	-
38999052	SPINNAKER WAVE (60 sq ft)	-	50101101	TRACK H17 TRAMPOLINE	OS
39100011	ANCHOR PLATE CLUB WAVE SHROUD	-	50101301	GUDGEON UPPER	-
39130021	END CAP FWD BLACK	-	50101401	GUDGEON LWR	-
39250000	MAIN TRAVELER KIT - CLUB WAVE	-	50101701	ANCHOR BAR - SHROUD	-
39312000	WAVE EZ LOC RUDDER ASSY - ADD	OS	50102011	GUDGEON CASTING H16	-
39341011	TRAMP TRACK WAVE CLUB	OS	50104001	CENTERBOARD PIVOT PIN H17	-
39382011	TILLER ARM WAVE EZ LOC	-	50121511	CROSSBAR H17 INSERT R/LR	-
39521001	TILLER XBAR WAVE "CLUB"	OS	50121611	CROSSBAR H17 INSERT L/F/R	-
39522001	TILLER XBAR WAVE "TENDON"	OS	50212001	DOLPHIN STRIKER ROD	OS
39524001	TILLER XBAR WAVE "EZ LOC"	OS	50212101	DOLPHIN STRIKER POST H17	-
39550001	HIKING STICK KIT - WAVE EZ LOC	OS	50212201	DOLPHIN STRIKER H17 SLEEV	-
39640020	MAST FLT PLT	-	50212301	DOLPHIN STRIKER BALL 17 / WAVE	-
39790001	WIRE SHROUD WAVE CLUB	-	50213201	CROSSBAR H17 INBOARD SUP FWD	-
39810001	WIRE FORESTAY WAVE CLUB	-	50221001	CROSSBAR H17/SPT EXT FWD	OS
39822011	WIRE BRIDLE WAVE CLUB	-	50251001	END CAP H17S TRAV TRK	-
39870000	BEACH DOLLY - WAVE	OS	50252021	TRACK H17 TRAVELER DEEP	-
39970000	TRAMP CLUB WAVE WHITE	-	50253001	B/U PLATE H17 REAR CROSSBAR	-
39970055	TRAMP CLUB WAVE BLACK MESH	-	50254001	DOLPHIN STRIKER H17 WASHR	-
39970058	TRAMP CLUB WAVE TURQ MESH	-	50261001	CROSSBAR H17 AFT EXT BLK	OS
40100001	SHROUD ANCHOR PLATE H20	-	50262101	CROSSBAR CAP H-17 PKG OF 4	-
40101301	GUDGEON H20	-	50312201	PLUNGER RUDDER H17/18	-
40110001	EXIT GROMMET	-	50312301	PIN RUDDER CAM H17/18	-
40131031	CROSSBAR H20 EXTRUS FWD	OS	50313001	EZ LOC RDR HOUSING	-
40140001	DOLPHIN STRIKER POST, H20	-	50313201	LINKAGE EZ LOC RDR HOUSING	-
40151021	END CAP H20 FWD X-BAR	-	50313301	RIVET LWR RDR HOUSING	-
40191031	CROSSBAR H20 EXTRUS AFT	-	50314001	EZ LOC - UP-LOCK PIN KIT	-
40210001	DECAL,TRAVELER ADJUSTMENT	-	50321001	RUDDER CASTING UP/RT BLK	-
40240001	OUTHHAUL ROLLER	-	50321111	TILLER ARM H17 BLACK	-
40250001	OUTHHAUL BEARING	-	50322001	RUDDER CASTING LWR BLACK	-
40260001	OUTHHAUL BEARING PIN	-	50341001	RUDDER CASTING UP/RT BLK	-
40309001	DAGGER WELL NEOPRENE KIT	-	50350140	CENTERBOARD SPRING H17	-
40330001	DAGGERBOARD, H20	OS	50351001	CENTERBOARD H17	-
40330101	DAGGERBOARD POS HOLDING SYSTEM	-	50403011	HALYARD HOOK H17	-
40340001	RUDDER PIN BUSHING H20 UPPER	-	50404101	LUFF TRACK UPDATE (12.5")	-
40360001	RUDDER PIN BUSHING H20 LOWER	-	50404111	LUFF TRACK UPDATE (14.8") H17	-
40380011	TILLER ARM H20	-	50406231	GOOSENECK H17	-
40401210	COMPTIP H20	OS	50406301	PIN H17/20/TIGER MAST STEP	-
40490001	RUDDER BLADE, H20	-	50412001	MAST HEAD H17 BLACK	-
40504501	WIRE TRAPEZE H20 PR.	-	50416011	MAST BASE H17/20/TIGER BLACK	-
40521001	TILLER XBAR ASSY H20	OS	50450001	ASSEMBLY MANUAL H17	-
40530001	TILLER CONNECTER POST	-	50502201	ROLL PIN, GOOSENECK BOOM PIN	-
40530021	TLR CONNECTER SCREW/CLUB	-	50504001	OUTHHAUL WIRE ASSY H17	-
40540001	TILLER CONN ADJUSTER THREADED	-	50504101	OUTHHAUL SLIDE H17	-
40550001	TILLER CONN END CAP - THREADED	-	50510000	BOOM H17 BLACK O/S	OS
40561001	END CAP TILLER CONNECT FIXED	-	50511011	SPREADER POLE EXT. SPORT	OS
40581000	MAST ASSY H20	OS	50512001	BOOM CAP H17 FWD BLACK	-
40590001	TILLER CONNECTOR RETAINER	-	50513011	BOOM CAP H17 AFT BLACK	-
40600001	TILLER EXTENSION BUSHING	-	50611011	COMPTIP H17	OS
40650001	END CAP,TILLER ARM SWIVEL	-	50650000	WING SET H17 W/O TRAMPS	OS
40660001	TILLER ARM INSERT	-	50650100	WING TRAMP H17 SET WHITE	-
40680001	INSERT BEARING TILLER CONNECTO	-	50650900	WING TRAMP H17 SET BLACK	-
40700541	DOWNHAUL SHEAVE H20	-	50650958	WING TRAMP H17 SET TURQ MESH	-

INDEX

50662001	WING CASTING H17 AFT BLK	-	61230000	SWIVEL JIB FURLER-EYE/EYE	-
50663001	WING CASTING H17 FWD BLK	-	61260000	SHEAVE - JIB HALYARD BLOCK	-
50665001	WING CAP H17	-	61290001	RING SS 3/16 X 1-3/16" ID	-
50666001	WING TUBE H17 INSIDE	OS	61290021	HALYARD RING W/LOOP	-
50670000	TRAMP SET H17 WHITE	-	61320001	TRAMP TRACK H18 PORT	OS
50670058	TRAMP SET H17 TURQ MESH	-	61330001	TRAMP TRACK H18 STBD	OS
50670091	TRAMP SET H17 BLACK MESH	-	61370000	POP-IN DECKPLATE-FLANGE ONLY	-
50670301	TRAMP LACING AFT H17 WHT	-	61380001	POP-IN HATCH-COVER ONLY	-
50670391	TRAMP LACING AFT H17 BLK	-	61382020	ACCESS PORT GASKET	-
50701101	WIRE BRIDLE H17 SE BLACK	-	61410000	SPREADER ROOT	-
50701201	WIRE FORESTAY H17 SE BLACK	-	61420000	SPREADER ARM H18	-
50701501	TRAPEZE SHOCKCORD H17	-	61430000	SPREADER BRACE	-
50702001	HANDLE CENTERBOARD H17	-	61440000	SPREADER ARM SLIDE	-
50772031	HINGE VERTEX,GOOSENECK	-	61480000	TANG DIAMOND WIRE	-
51410000	MAST ASSY H17 SE/SPT '95	OS	61490000	COMPRESSION SLEEVE H18	-
52009001	SPREADER POLE END CAP SPORT	-	61510000	EYE STRAP	-
52410011	HOOK-SPORT DOWNHAUL	-	61530000	ROPE LOCK	-
52411001	WASHER MAST BASE H17/20	-	61570000	THIMBLE 1/16" SS HVY DUTY	-
52450011	ASSEMBLY MANUAL 17S	-	61610101	HALYARD HOOK H18/20 COMPTIP	-
52500001	SPREADER POLE ASSY SPORT	OS	61661001	WIRE JIB HALYARD ASSY H18	-
52500101	BRIDLE LWR SPORT (SS)	-	61670000	BALL BEARING (18 PER FURLER)	-
52500201	WIRE BRIDLE UPR SPORT	-	61711000	BOOM CLEAT CLAMP H18	-
52502021	SPREADER POLE END CASTING	-	61740000	ROLLER DIAMOND WIRE H18	-
52503001	SPREADER POLE YOKE	-	61750001	WIRE DIAMOND H18 W/TURNUCKLE	-
52661001	WIRE JIB HALYARD SPORT	-	61770000	TURNUCKLE 1/8" FLAT JAW	-
52721111	BALL MEDIUM 6 MM BLACK	-	61800001	TRAVELER ASSEMBLY - MAIN	-
52722011	SPORT SAIL FOOT "BOOMLET"	-	61810000	ROLLER SKID - TRAVELER	-
52812001	WIRE SPORT FORESTAY LWR	-	61830000	BUSHING SHAFT - TRAVELER	-
52812011	WIRE SPORT FORESTAY UPR	-	61842000	TRAVELER CAR BODY SUB ASSY	-
52991000	SAIL H17SE/SPT MAIN WHITE	OS	61852000	BEARING SET (2 CYLINDERS)	-
52991074	SAIL H17SE/SPT MAIN SMOKE	OS	61870000	TRAVELER DECK PLATE	-
52991991	SAIL H17SE/SPT MAIN - CUSTOM	OS	61880000	SPACER,H18 TRAVELER CAR	-
52992006	SAIL SPORT JIB WHITE DACR	-	61890000	SHEAVE TRAVELER CAR	-
52992023	SAIL SPORT JIB - CUSTOM	-	61900000	JIB FURLER ASSY	-
53180011	HOG RING 3/8" S/S FOR 3/16" BU	-	61900900	FURLER TUNE UP KIT	-
53790141	HOOK JIB GTW / TRIFOILER	-	61910000	FURLER TUBE ROLLER	-
60060000	MAST FOAM PLUG H18	-	61920000	FURLER BEARING RACE	-
60102011	GUDGEON H18 CASTING KIT	-	61930000	FURLER BEARING CAGE	-
60110000	MAST BEARING H18	-	61940000	FURLER NYLON SLEEVE 1" ID X 1.	-
60120000	TANG H18 BOW	-	61950001	FURLER SLEEVE	-
60132010	CROSSBAR H18 EXT FWD BLK	OS	61960001	FURLER SPOOL&HOUSING	-
60140001	DOLPHIN STRIKER H18 POST	-	61980000	FURLER BRIDLE YOKE	-
60150011	CROSSBAR H18 CSTG FWD LT BLK	-	62260001	CLAMCLEAT LEECHLINE CLEAT	-
60160011	CROSSBAR H18 CSTG FWD RT BLK	-	62270000	CLEW PLATE (3 HOLE)	-
60170011	MAST H18 STEP BLACK	-	62300000	ZIPPER JIB LUFF	-
60180011	MAST H18 STEP ASSY BLACK	-	62330000	DECAL H18 SAIL - CLASS INSIG	-
60191211	CROSSBAR H18 AFT EXTR BLACK	OS	63780000	TRAMP LACING AFT H18 WHT	-
60200011	CROSSBAR H18 CSTG AFT RT BLK	-	64100001	SHROUD ANCHOR PLATE KIT (PAIR)	-
60210011	CROSSBAR H18 CSTG AFT LT BLK	-	64130001	RAIL REINFORCEMENT KIT H18	-
60220001	BOOM H18 OUTHAUL SL ASY	-	65071001	WING MOUNT KIT-SHORT BAR	-
60240000	BOOM H18 OUTHAUL BEARING	-	65100000	WING STRUT TAB H18	-
60250000	BOOM PIN H18 OUTHAUL BRNG	-	68040255	WING TRAMP SX/21SE SET BLK	-
60270000	FAIRLEAD H18 THRU-DECK	-	68091001	WING LEG H18SX FWD/LT	-
60300001	DAGGERBOARD H18	OS	68101001	WING LEG H18SX FWD/RT	-
60309001	DAGGER WELL NEOPRENE KIT	-	68111001	WING LEG H18SX AFT/LT	-
60330031	JIB SLIDE H18/20 (WITH 1/4-20)	-	68121001	WING LEG H18SX AFT/RT	-
60330041	BLOCK HARKEN JIBSHEET	-	68190001	ANCHOR PLATE, SX WINGS	-
60331010	RUDDER CONV KIT H18 BLACK	-	68330011	HEADBOARD ALUM W/RIVETS	-
60380111	TILLER ARM H18 STR BLACK	-	68503501	TRAPEZE WIRE SX18 BLACK	-
60400011	RUDDER ADJUSTER KIT	-	68581000	MAST ASSY H18SX BLACK	OS
60450000	SCREW DELRIN RUDDER	-	68661001	WIRE H18SX JIB HALYARD	-
60550001	TILLER EXTENSION H18/21 (106")	OS	68750001	WIRE H18SX DIAMOND	-
60602041	MAST HEAD H18 COMPTIP	-	68793501	WIRE H18SX SHROUD BLACK	-
60610010	MAST ASSY H18 BLACK	OS	68813501	WIRE H18SX FORSTAY UPR	-
60611100	COMPTIP H18	OS	68814501	WIRE H18SX FORSTAY LWR	-
60620000	SHEAVE 1"	-	68991100	SAIL H18SX MAIN WHITE	OS
60641031	MAST BASE CASTING H18	-	68992100	SAIL H18SX JIB WHITE	OS
60650011	MAST BASE HINGE CSTG H18	-	70000111	BEACH DOLLY EURO H16	OS
60670000	SHACKLE,TWIST 3/16 PIN	-	70050001	HOBBIE BOAT CLEANER-12oz	-
60680001	COMPRESSION PLATE ASSY - MAST	-	70060001	HOBBIE UV PROTECTANT-12oz	-
60710000	GOOSENECK YOKE	-	71130001	HATCH SCREW-IN w/LIP-BLK 5"	-
60720011	BOOM H18 BLACK	OS	71175001	HATCH BAG 6.0 DIA.-RED	-
60730001	TRAPEZE SHOCK CORD H18	-	71190011	HANDLE - LIFTING (WEB - BRAVO)	-
60730002	TRAPEZE SHOCKCORD W/HKS	-	71190021	HANDLE - LIFTING '08 (WEB - B	-
60751010	BOOM CAP H18 FWD BLACK	-	71220001	PAD EYE - CHROME	-
60760011	BOOM CAP H18 AFT BLACK	-	71321001	GASKET KAYAK HATCH 6"	-
60790001	SHROUD H18/21SC WHITE	-	71331001	GASKET KAYAK HATCH 8"	-
60792001	SHROUD H18/21SC BLACK	-	71701001	HATCH 6" TWIST-N-SEAL RETRO	-
60810011	WIRE H18/21SC FSTAY UPR	-	71701011	HATCH 6" TWIST-N-SEAL	-
60810021	WIRE H18/21SC FSTAY WHT	-	71701021	O RING 6" TWIST-N-SEAL	-
60812021	WIRE H18/21SC FSTAY BLK	-	71702001	HATCH 8" TWIST-N-SEAL RETRO	-
60820001	WIRE H18 BRIDLE WHITE	-	71702011	HATCH 8" TWIST-N-SEAL	-
60822001	WIRE H18 BRIDLE BLACK	-	71702021	O RING 8" TWIST-N-SEAL	-
60830000	STAY ADJUSTER (FOR JIB FURLER)	-	71703001	HOBBIE DRY BAG 8.0"	-
60880001	RUDDER PIN H17/18	-	71707001	RECTANGULAR HATCH ASSY BLACK	-
60880011	RUDDER PIN, ST. STEEL H17/18	-	71707002	GASKET - RECTANGULAR HATCH	-
60970000	TRAMP SET H18 WHITE	-	71708001	TACKLE MANAGEMENT RACK	-
60970055	TRAMP SET, H18 BLK MESH	-	71709001	BUCKET, HOBBIE RECTANG HATCH	-
60970058	TRAMP SET H18 TURQ MESH	-	71710001	RECTANGULAR HATCH ASSY WHITE	-
60991011	SAIL H18 MAIN WHITE	-	71995001	WATER BOTTLE - STAINLESS	-
60991086	SAIL H18 MAIN CORONADO '08	-	72020000	HOBBIE GEAR KEEPER SMALL 36"	-
60991991	SAIL H18 MAIN - CUSTOM	-	72020001	HOBBIE GEAR KEEPER LARGE 36"	-
60992011	SAIL H18 JIB WHITE	-	72020003	HYDRO STAR SOS DLX LIGHT	-
60992071	SAIL H18 JIB TURQUOISE	-	72020010	HOBBIE SAFETY KIT	-
60992991	SAIL H18 JIB - CUSTOM	-	72020030	TEAR-AID / TYPE A (POLY)	-
61010001	INBOARD SUPPORT CSTG H18 FWD	-	72020031	TEAR-AID / TYPE B (VINYL)	-
61020001	INSERT NUT - INBD SUPT CSTG H1	-	72020032	BILGE - HAND PUMP	-
61040001	INBOARD SUPPORT CSTG H18 REAR	-	72020078	HOBBIE FIRST AID KIT	-
61060001	DEAD EYE TRAVELER	-	72020087	COOLER - PA BUCKET / ALL CARGO	-
61070000	CLAMCLEAT JUNIOR CL203	-	72020092	RESCUE STEP - KAYAK	-
61070010	CLAMCLEAT RACE JUNIOR	-	72020120	TROLLING MOTOR X15 50" FRESH	-
61080000	MAST SEAL PLATE H18	-	72020121	TROLLING MOTOR X15 50" SALT	-
61110000	CHANNEL - XBAR NUT UNDER LIP	-	72020123	BATTERY CHARGER 12 / 6 VOLT	-
61120001	BACK UP CASTING - H18 BOW TANG	-	72020124	PROP WEEDLESS 2 BLADE 3.5"	-
61140000	SLEEVE DOLPHIN STRIKER	-	72020125	PROPNUT / WRENCH / PINS	-
61170001	DOLPHIN STRIKER ROD H18	OS	72020126	PINPOINT GPS GATEWAY KIT	-
61210001	MAST ROTATION BAR	-	72020127	NMEA2000 STARTER KIT	-

INDEX Continued...

72020128	6-PIN LOWRANCE TOUR ADAP	-	1474W	TRAP WIRES H18 WHT W/SHCK	-
72021015	MARINE GOOP 3.7oz CLEAR	-	1475B	TRAP WIRES H14 BLK	-
72042001	TIE DOWN STRAPS HOBIE- 12 FOOT	-	1476B	TRAP WIRES H14 BLK W/SHCK	-
72043001	TIE DOWN STRAPS HOBIE- 15 FOOT	-	1478B	TRAP WIRES GETAWAY BLK	-
72410001	DAGGERBOARD COVER TIGER/FOX/FX	-	1521H	BATTEN CAP KIT, H14/17 LEACH	-
79050211	DRAIN PLUG - 3/8" W O-RING&KEE	-	1522H	BATTEN CAP KIT, H16 MAIN LEACH	-
79545001	DECAL, HOBIE DOME, GOLD 2.75"	-	1523H	BATTEN CAP KIT, H18 LEACH	-
80100501	SAIL FEEDER - HOBIE	-	1531H	BATTEN CAP KIT, H16 JIB	-
80181001	YOKE TILLER CONNECTOR	-	1553CR	CROAKIES "HOBIE"	-
80200000	TURBO H14 JIB RIGGING KIT	-	1553L	LID LATCH MULTI-COLOR	-
80200010	DOLPHIN STRIKER KIT H14	-	1671BLK	RAIL RUG KIT BLACK - H14/16	-
80200020	TURBO H14 JIB UPDATE KIT	-	1825LID	LID TOYBOX FWD - FIBERGLASS	-
80201300	TURBO JIB BLOCK SUPPORT WIRE	-	1825WHT	TOYBOX	OS
80550005	BATTEN MAIN PKT PROTECTOR KIT	-	2004BLK	J & H HANDLES-BLACK	-
80660000	AUSSIE H16 JIB HALYARD KIT W/	-	2004WHT	J & H HANDLES-WHITE	-
82010001	BATTEN UNIVERSAL 107-7/8"	OS	314-13ALL	COVER UNIVERSAL UP TO 13' WAVE	-
82020001	BATTEN UNIVERSAL 82-3/8"	OS	314-14TO17	COVER UNIVERSAL 14'-17'	-
82030001	BATTEN UNIVERSAL 90-1/8"	OS	314-16GTWY	COVER GETAWAY	-
82040001	BATTEN UNIVERSAL 42-11/16	-	314-17TO18	COVER UNIVERSAL 17'-18'	-
82060001	BATTEN UNIVERSAL 100 9/16	OS	314-19TO20	COVER UNIVERSAL 19'-20'	-
82070001	BATTEN UNIVERSAL 67-1/2" JIB (	OS	3188LG	GLOVES HOBIE LARGE	-
82080001	BATTEN UNIVERSAL 43 3/4" JIB	-	3188MD	GLOVES HOBIE MEDIUM	-
82410020	COVER - DAGGERBOARDS H20	-	3188SM	GLOVES HOBIE SMALL	-
82420000	COVERS - RUDDER (PAIR)	-	3188XL	GLOVES HOBIE X LARGE	-
84430026	DVD - H14/H16 RIGGING -	-	3252W	WIRE COVERS 1/8" WHITE	-
84430128	DVD - GETAWAY RIGGING	-	3253W	WIRE COVERS 5/32" WHITE	-
84430202	DVD - SHARING THE WIND, MOMENT	-	3261B	SHROUD ADJ COVERS BLK 12" PAIR	-
84430203	DVD - HOBIE FILM FESTIVAL	-	3850LG	HOBIE SPRAY TOP LG	-
84430401	VIDEO CATAMARAN SAILING - DVD	-	3850MD	HOBIE SPRAY TOP MD	-
87369116	BOOK, HOBIE-MASTER OF WATER,	-	3850SM	HOBIE SPRAY TOP SM	-
90170001	MAST STEP ASSY / BRAVO OLDER	-	3850XL	HOBIE SPRAY TOP XL	-
90170011	MAST STEP ASSY / BRAVO NEWER	-	5016BL	VISOR HOBIE BLUE	-
90312000	BRAVO EZ LOC RUDDER ASSY - REQ	-	5019BK	HAT "HOBIE" 6-PANELLO PRO BLK	-
90382011	TILLER ARM - BRAVO EZ LOC	-	5024LG	HAT, AUSSIE LG (60cm/23.6") KH	-
90440011	PAD HIKING STRAP - BRAVO	-	5026BM	HAT, BEANIE MEN'S BLK w/ RED L	-
90440021	HIKING STRAP ADJUST - BRAVO	-	5026BW	HAT, BEANIE WOMEN'S WHT w/LT B	-
90440050	BLOCK LARGE BULLET	-	5027OM	HAT- ODM	-
90500021	MAST KEEPER GATE ASSY	-	5028LXL	HAT, HOBIE PENGUIN FLEX-FIT LX	-
90500022	MAST KEEPER HINGED GATE ASSY	-	5030LXL	HAT, HOBIE PATCH OLIVE/BLACK	-
90501031	CSTG A-FRM CONNECTOR	-	5030SM	HAT, HOBIE PATCH OLIVE/BLACK	-
90501036	FURLER LINE KEEPER STRAP ASSY	-	5033LXL	HAT, HOBIE PATCH GRAY/BLACK	-
90502031	KNOB ASSY - MAST GATE	-	5033SM	HAT, HOBIE PATCH GRAY/BLACK	-
90502041	KNOB ASSY - MAST GATE / NEWER	-	5037LXL	HAT, PVC FLYING H RED	-
90550001	BRAVO TILLER EXTN ASSY *OLD ST	-	5037SM	HAT, PVC FLYING H RED	-
90550011	BRAVO TILLER EXT - EZ LOC	-	5038LXL	HAT, PVC FLYING H KHAKI	-
90560020	TILLER END CAP BRAVO - OLDER	-	5038SM	HAT, PVC FLYING H KHAKI	-
90560041	TILLER END CAP BRAVO - EZ LOC	-	5351B	HATCH COVER KIT 5' BLACK	-
90600012	MAST FLOAT BRAVO (UNIVERSAL)	-	5351W	HATCH COVER KIT 5' WHITE	-
90600021	SADDLE STRAP/BRAVO FLOAT	-	5352B	HATCH COVER KIT 4" BLACK	-
90600041	MAST FLOAT WEB STRAP/BUCKLE	-	5352W	HATCH COVER KIT 4" WHITE	-
90610101	COLLAR BRAVO MAST	-	5353B	HATCH COVER KIT 6" BLACK	-
90610111	DELRIIN BALL 3/8 DIA - FURLERS	-	5353W	HATCH COVER KIT 6" WHITE	-
90610121	FURLER LINE - BRAVO	-	72000B	POUCH GUSSETED 6x12	-
90611001	COMPTIP HOBIE BRAVO	OS	72005B	POUCH SUPER GUSSETED 8x15	-
90612111	MAST BEARING - INJ MOLD	-	72210T	SEE BAG 8" X 14"	-
90613000	MAST BRAVO LOWER T/F	OS	72230T	SEE BAG 11" x 19"	-
90640011	MAST BASE BRAVO	-	80000R	ROLLING DUFFLE/GEARBAG	-
90640021	BALL - MAST ROTATION	-	80035A	ANCHOR w/BAG & LINE (3.5 LB)	-
90700011	WIRE BRAVO MAINSHEET ATTACHMEN	-	B094	SWIVEL SHACKLE	-
90700050	COVER BRAVO A-FRAME	-	B323	BULLSEYE W/FERRULE	-
90700121	BLOCK SINGLE w/BECKET BLACK	-	CL212A	JIB HALYARD CLEAT SHIELD	-
90700131	BLOCK RATCHET LOWER BRAVO (EZ	-	CM7703	BRIDLE VANE - STANDARD	-
90700201	BRACKET MAINSHEET ATTACH - BRA	-	CM7704	VANE REPLACEMENT	-
90701001	A-FRAME REPLACEMENT KIT 2-PC	-	CM7705	BRIDLE VANE ADAPTOR - FURLER	-
90710000	A-FRAME SUPPORT w/STRAP-NEWER	-	CM7732	L/L SISTER CLIPS	-
90710009	END CAP, VERT SPRT 5/16 - 18	-	F14061106	PLUNGER TIGER	-
90710010	END CAP, VERT SPRT 5/16-18	-	F14061122	CAM STOP PLATE	-
90710011	A-FRAME SUPPORT w/STRAP - OLDER	-	F14061180	CAM RUDDER TIGER	-
90711001	A FRAME ATTACH-OLD STYLE 1/4-2	-	F14530200	T2 SPINNAKER KIT W/O SPINNAKER	-
90711011	A FRAME ATTACH-NEW STYLE 5/16-	-	F14530250	T2 YELLOW SOFT SPINNAKER	-
90720000	BOOM ASSY BRAVO	OS	F14530260	T2 ORANGE SOFT SPINNAKER	-
90720101	GSKN BOOM CLIP - BRAVO	-	F14530270	T2 RED SOFT SPINNAKER	-
90870000	BEACH DOLLY - BRAVO	OS	F16032110	SPINNAKER H16 TRUMPET	OS
90880211	PINTLE UPR - EZ LOC	-	F16034006	VELCRO BATTEN TOOL - H16 JIB	-
90880221	PINTLE LWR - EZ LOC	-	F16041755	TIGER CAM PIN	-
90880231	RETAINER CLIP EZ LOC RDR HOUSI	-	F16056025	TIGER SPIN. POLE CONNECTOR	-
90990021	SAIL BRAVO 3.8 OZ-SEABREEZE	-	F16630300	GENNAKER WHITE TATOO/T2	-
90990099	SAIL BRAVO - CUSTOM	-	F16631300	GENNAKER HARDWARE KIT TATOO/T2	-
90991000	BAG MAST/SAIL BRAVO	-	F17000010	UPPER RUDDER CSTING TIGER	-
90992000	BAG SAIL BRAVO (SAIL ONLY)	-	F17062680	RUDDER CASTING LOWER HCE	-
91011011	BRAVO BATTEN #1 (5' 6 1/2")	-	F18012817	BOOM TIGER '03	-
91021111	BRAVO BATTEN #2 (11' 6 5/8")	-	F18025840	TRAMP TIGER BLACK MESH	-
91031011	BRAVO BATTEN #3 (10')	-	F18030196	SPINNAKER TIGER YELLOW	-
91050010	HOOK WHT NYLON SEW-ON	-	F18030199	SPINNAKER TIGER RED	-
91050020	HOOK BLK NYLON SEW-ON	-	F18030245	SAIL TIGER MAIN STX SMOKE	OS
91281000	DRAIN SCREW W/WASHER WV/TF/20/	-	F18030265	SAIL TIGER MAIN STX WHITE	OS
92870000	SHACKLE HEADBOARD 3/16	-	F18030291	SPINNAKER TIGER WHITE	-
96280000	SLUG SLIDE 5/16" NYLON	-	F18030295	SPINNAKER TIGER BLUE	-
1376LG	HARNESS AUTOMATIC LG	-	F18030400	SAIL TIGER JIB BATTENED WHITE	OS
1376MD	HARNESS AUTOMATIC MD	-	F18030410	SAIL TIGER JIB BATTENED SMOKE	OS
1376SM	HARNESS AUTOMATIC SM	-	F18030420	SAIL, TIGER JIB BATTENED BLUE	OS
1376XL	HARNESS AUTOMATIC XL	-	F18034200	TIGER BATTEN SET S.T.X.	OS
1378LG	HARNESS CONVERTIBLE LG	-	F18042712	HALYARD RING-EURO	-
1378SM	HARNESS CONVERTIBLE S/MD	-	F18042755	MAST ASSY TIGER '03	OS
1378XL	HARNESS CONVERTIBLE XL	-	F18050905	DAGGERBOARD TIGER	OS
1388LG	SKIPPERS HARNESS LARGE	-	F18056005	GUDGEON TIGER W/BUSHING	-
1388MD	SKIPPERS HARNESS MEDIUM	-	F18056012	GUDGEON, TIGER UPR '07	-
1388SM	SKIPPERS HARNESS SMALL	-	F18056014	GUDGEON, TIGER LWR '07	-
1388XL	SKIPPERS HARNESS X LARGE	-	F18056033	HATCH 5" TIGER/WC RWO	-
1470B	TRAP WIRES WAVE BLK	-	F18060301	ROPE LOCK SINGLE	-
1471B	TRAP WIRES H16/17 BLK	-	F18060458	SPINNAKER HALYARD TI / WC	-
1471W	TRAP WIRES H16/17 WHT	-	F18060508	WIRE SHROUD TIGER	-
1472B	TRAP WIRES H16 BLK W/SHCK	-	F18060518	FORESTAY TIGER w/PIGTAIL (CURR	-
1472W	TRAP WIRES H16 WHT W/SHCK	-	F18060519	FORESTAY TIGER ROLLER FURLER	-
1473B	TRAP WIRES H18 BLK (ONE SIDE)	-	F18060555	JIB HALYARD WIRE HC18TI	-
1473W	TRAP WIRES H18 WHITE	-	F18060565	DIAMOND WIRE TIGER	-
1474B	TRAP WIRES H18 BLK W/SHCK	-	F18060572	WIRE TRAPEZE TIGER PR.	-

INDEX

F18061579	WIRE BRIDLE 18TI	-	RF4850MD	GLOVES-FINGERLESS MD STICKY	-
F18062160	TILLER ARM, TIGER	-	RF4850SM	GLOVES-FINGERLESS SM STICKY	-
F18062261	TILLER X-BAR TIGER	OS	RF4850XL	GLOVES-FINGERLESS XL STICKY	-
F18062645	POLE, SPINNAKER TIGER TRUMPET	OS	RF4850XS	GLOVES-FINGERLESS XS STICKY	-
F18062990	WING SET TIGER COMFORT	OS	RF4851LG	GLOVES-3 FINGER LG STICKY	-
F18712800	BOOM, WILD CAT	OS	RF4851MD	GLOVES-3 FINGER MD STICKY	-
F18730000	SAIL, MAIN WILD CAT WHITE	OS	RF4851SM	GLOVES-3 FINGER SM STICKY	-
F18730010	SAIL, MAIN WILD CAT SMOKE	OS	RF4851XL	GLOVES-3 FINGER XL STICKY	-
F18730020	SAIL, MAIN WILD CAT RED	OS	RF4851XS	GLOVES-3 FINGER XS STICKY	-
F18730030	SAIL, MAIN WILD CAT BLUE	OS	RF5001	CAM CLEAT SM RED	-
F18730100	SAIL, JIB WILD CAT WHITE	-	RF5004	SMALL ROPE GUIDE	-
F18730110	SAIL, JIB WILD CAT SMOKE	-	RF5005	SMALL "FAST TRACK" FAIRLEAD	-
F18730120	SAIL, JIB WILD CAT RED	-	RF5011	CLEAT CAM RONSTAN	-
F18730130	SAIL, JIB WILD CAT BLUE	-	RF5015	MEDIUM "FAST TRACK" FAIRLEAD	-
F18730200	SPINNAKER, WILD CAT WHITE	-	RF56100	BLOCK SERIES 55 AUTO RATCHET	-
F18730210	SPINNAKER, WILD CAT BLACK	-	RH014WHT	LINE 1/4" STRAIT-CORE POLY	-
F18730220	SPINNAKER, WILD CAT RED	-	RH018WHT	LINE 1/8" NYLON BRAID WHITE	-
F18730230	SPINNAKER, WILD CAT BLUE	-	RH038WHT	LINE 3/8" STRAIT-CORE POLY	-
F18742700	MAST, WILD CAT	OS	RH112WHT	LINE 1/12" BRAID WHITE	-
F18750920	RUDDER BLADE, WILD CAT	-	RH316WHT	LINE 3/16" STRAIT-CORE POLY	-
F18750960	DAGGERBOARD WILD CAT (LONG)	OS	RH516WHT	LINE 5/16" STRAIT-CORE POLY	-
F21060056	BALL SET 74PC	-	RL012BLU	LINE 1/2" HOLLOW BRAID BLU/WHT	-
F21062673	TIGER STEP BALL	-	RLH4BYB	LINE 4MM MAGIC GOLD BLK/YEL/BL	-
F21080335	RUDDER PIN TIGER	-	RLH5BLU	LINE 5MM HERCULES COLOUR BLUE	-
F99267527	SPINNAKER BAG SOFT '07	-	RLH5RYB	LINE 5MM MAGIC GOLD RED/YEL/BL	-
F99267585	TIGER COVER	-	RLH5YEL	LINE 5MM MAGIC D PRO YELLOW	-
F99267635	BOAT COVER WILD CAT	-	RLH5YRB	LINE 5MM MAGIC GOLD YEL/RED/BL	-
F99268010	RUDDER COVER WILD CAT	-	RLM10YEL	LINE 10MM NAUTIC YELLOW	-
F99268017	COVER, DAGGERBOARD WILD CAT LG	-	RLM70W	LINE 7MM MAGIC SHEET ORG/WHT F	-
F99502230	RUDDER BLADE TIGER	-	RLM9SW	LINE 9MM MAGIC SHEET SILV/WHT	-
F99502280	RUDDER BLADE, TIGER '07	-	RLS4BLK	SHOCKCORD 4MM BLACK	-
F99502360	TILLER EXT CARBON WILD CAT	-	RLS5BLK	SHOCKCORD 5MM BLACK	-
FX3	HOTSTICK 52"-96"	OS	RM014BLK	LINE 1/4" SPUN DACRON - BLACK	-
FX4	HOTSTICK 57"-105"	OS	RM014BLU	LINE 1/4" SPUN DACRON - BLUE	-
FX6	HOTSTICK MAGNUM 63"-120"	OS	RM014RED	LINE 1/4" SPUN DACRON - RED	-
H001	BLOCK SINGLE 2.25"	-	RM014WHT	LINE 1/4" SPUN DBL BRD - WHITE	-
H002	BLOCK SINGLE W/BKT 2.25"	-	RM038BLK	LINE 3/8" SPUN DACRON - BLACK	-
H004	BLOCK-2.25" DOUBLE W/BKT	-	RM038BLU	LINE 3/8" SPUN DACRON - BLUE	-
H019	BLOCK-2.25" HEX STBD	-	RM038RED	LINE 3/8" SPUN DACRON - RED	-
H048	BLOCK TRIPLE 2.25	-	RM038WHT	LINE 3/8" SPUN DBL BRD - WHITE	-
H071	SPRING-STANDUP	-	RM516BLK	LINE 5/16" SPUN DACRON - BLK	-
H072	SHACKLE-3/16" W/PIN & RING	-	RM516BLU	LINE 5/16" SPUN DACRON - BLUE	-
H082	BLOCK-SINGLE BULLET	-	RM516RED	LINE 5/16" SPUN DACRON - RED	-
H083	BLOCK-BULLET W/BECKET	-	RM516WHT	LINE 5/16" SPUN DBL BRD-WHITE	-
H084	BLOCK-BULLET DOUBLE	-	RM716BLK	LINE 7/16" SPUN DACRON - BLACK	-
H092	BLOCK-BULLET CHEEK	-	RM716BLU	LINE 7/16" SPUN DACRON - BLUE	-
H093	SPRING, MICRO CAM CLEAT MS-093	-	RM716RED	LINE 7/16" SPUN DACRON - RED	-
H097	STAND UP SPRING-SMALL	-	RM716WHT	LINE 7/16" SPUN DACRON - WHITE	-
H099	BLOCK-BULLET W/BCKT (HI LOAD)	-	RS014BLK	SHOCKCORD 1/4" BLACK	-
H125	BLOCK-BIG BULLET	-	RS018BLK	SHOCKCORD 1/8" BLACK	-
H126	BLOCK-BIG BULLET W/BECKET	-	RS038BLK	SHOCKCORD 3/8" BLACK	-
H137	EYESTRAP-LARGE SS	-	RS316BLK	SHOCKCORD 3/16" BLACK	-
H138	SHACKLE ASSY-1/4" SS	-	RS516BLK	SHOCKCORD 5/16" BLACK	-
H145	CAM-MATIC WEDGE KIT	-	RS716BLK	SHOCKCORD 7/16" BLACK	-
H150	CAM CLEAT-CAM MATIC ALUMINUM	-	S6100LG	PFDF THINBACK MANGO - LARGE	-
H160	SHEAVE-BULLET	-	S6100MD	PFDF THINBACK MANGO - MEDIUM	-
H166	BLOCK-BULLET SWIVEL	-	S6100XL	PFDF THINBACK MANGO - X LARGE	-
H167	BLOCK-BULLET SWIVEL W/BECKET	-	S6101LG	PFDF THINBACK RED - LARGE	-
H168	BLOCK-BIG BULLET SWIVEL	-	S6101MD	PFDF THINBACK RED - MEDIUM	-
H170	BLOCK-3" HEXCAT BASE W/CAM	-	S6101XL	PFDF THINBACK RED - X LARGE	-
H174	END STOP-SB HI BEAM (2)	-	S6102LG	PFDF THINBACK GR GREEN - LARGE	-
H177	BALLS-1/4" TORLON (20)	-	S6102MD	PFDF THINBACK GR GREEN - MEDIUM	-
H194	BLK-2.25" LO PRO TRIPLE HEX	-	S6102XL	PFDF THINBACK GR GREEN - X LARG	-
H201	EYESTRAP-LO PRO SS	-	S6110LG	PFDF THINBACK MANGO (W) LG	-
H205	CAM BASE-SMALL SWIVEL	-	S6110MD	PFDF THINBACK MANGO (W) MD	-
H2139	BLK 2.25" CARBO RATCHET/CAMMAT	-	S6110SM	PFDF THINBACK MANGO (W) SM	-
H224	BLOCK-MICRO SINGLE	-	S6114LG	PFDF THINBACK BLUE (W) LG	-
H225	BLOCK-MICRO W/BECKET	-	S6114MD	PFDF THINBACK BLUE (W) MD	-
H226	BLOCK-MICRO DOUBLE	-	S6114SM	PFDF THINBACK BLUE (W) SM	-
H227	BLOCK MICRO DOUBLE W/BKT	-	S6120XL	PFDF EDGE RED LG/XL	-
H228	BLOCK-MICRO TRIPLE	-	S6120SM	PFDF EDGE RED SM/MD	-
H231	BLOCK-MICRO TRIPLE W/CAM	-	S6120XL	PFDF EDGE RED XXL	-
H232	BLOCK-MICRO TRAVELER	-	S6770CMG	PFDF CHILD MANGO 30-50#	-
H233	BLOCK-MICRO CHEEK	-	S6770IMG	PFDF INFANT MANGO <30#	-
H237	BULLSEYE FAIRLEAD	-	S6770YMG	PFDF YOUTH MANGO 50-90#	-
H244	BLOCK MICRO FIDDLE W/V-JAM	-	S6779MG	PFDF INFLATABLE MANGO	-
H2640	TRIPLE 40mm CARBO BLOCK	-	S6779R	PFDF INFLATABLE REARM KIT	-
H281	EYESTRAP-MICRO SS	-	S6779RG	PFDF INFLATABLE RED/GRAY	-
H284	KIT-MICRO WIRE FAIRLEAD	-	S6779TG	PFDF INFLATABLE TAN/GRAY	-
H285	SAIL CHAFE PROTECTOR SET	-	S6780RG	PFDF BELT PACK SUP INFLATABLE R	-
H291	BLK-BULLET PIVOT EXIT W/CAM	-	S6800LXL	PFDF MIRAGE GRAY - LARGE/XL	-
H297	WEDGE KIT-MICRO CAM	-	S6800MLG	PFDF MIRAGE GRAY - MEDIUM/LG	-
H298	FAIRLEAD-KIT-CAM-MATIC WIRE LG	-	S6800SM	PFDF MIRAGE GRAY - SMALL/MED	-
H300	BLOCK-1" WIRE	-	S9000LG	PET PFD LG MANGO 60-90#	-
H344	29mm CARBO TRIPLE SWIVEL	-	S9000MD	PET PFD MD MANGO 24-60#	-
H347	29mm CARBO TRIPLE w/CLEAT	-	S9000SM	PET PFD SM MANGO 12-24#	-
H350	29mm CARBO CHEEK	-	S9000XL	PET PFD XL MANGO >90#	-
H353	BLOCK-BULLET TRAVELER	-	S9000XS	PET PFD XS MANGO <12#	-
H365	CAM CLEAT-PL HI PERFORMANCE LP	-	SP150041	SHACKLE 5/32 X 3/8 X 5/8	-
H404	BLOCK-16MM AIR FXD SGL	-	SP150051	SHACKLE 3/16x1/2x11/16	-
H405	BLOCK-16MM AIR FIXED SGL W/BKT	-	SP150052	SHACKLE 3/16 x 5/8 x 5/16	-
H406	BLOCK-16MM AIR FIXED DOUBLE	-	SP150053	SHACKLE 3/16 X 5/8 X 1-7/16	-
H407	BLOCK-16MM AIR FIXED DBL W/BKT	-	SP150061	SHACKLE 1/4x9/16x15/16	-
H424B	FAIRLEAD MICRO CAM - BLK	-	SP150081	SHACKLE 5/16x11/16x13/16	-
H471	CAM CLEAT-MICRO CARBO	-	SP170005	SHACKLE TWISTED SS 3/16	-
HFS100	SCREW 8-32 X .188 18-8 SLTTR	-	SP170006	SHACKLE TWISTED SS 1/4	-
HSB56	CAM SPRING-150 & 200	-	SP180005	SHACKLE W/SAFETY KEY PIN 3/16"	-
HSPAP	SCREW 1/4-20 X 3/4 THMS-P SS	-	SP180006	SHACKLE W/SAFETY KEY PIN 1/4"	-
MK0046	HOBIE CAUTION FLAG	-	SP180008	SHACKLE SAFETY 5/16	-
MK0053	SAFETY WHISTLES	-	SP185205	SHACKLE W/ SAFETY KEY PIN 3/16	-
R359P	LANCE CLEAT PORT	-	V1093	SCREW-IN DECKPLATE 5" CRVD WH	-
R359S	LANCE CLEAT STBD	-	V1100	SCREW-IN DECKPLATE 5" CRVD BLA	-
RF05BW	LINE ROBLINE RACE 5MM BLUE/WHT	-	V1130	SCREW-IN DECKPLATE 4" CRVD WH	-
RF08BLU	LINE ROBLINE RACE 8MM BLUE/WHI	-	V1131	SCREW-IN DECKPLATE 4" CRVD BL	-
RF4050	CLEAR START RACE TIMER	-	V1145	SCREW-IN DECKPLATE 6" WHITE W	-
RF4052A	CLEAR START SAILING WATCH	-	V1146	SCREW-IN DECKPLATE 6" BLACK W	-
RF4850LG	GLOVES-FINGERLESS LG STICKY	-			-



**HOBIE CAT COMPANY**

Holding Company  
Oceanside, CA, U.S.A.  
1-800-HOBIE-49  
hobiecat.com

**HOBIE CAT AUSTRALASIA**

Subsidiary  
Huskisson, NSW, Australia  
1-800-4-HOBIE  
hobiecat.com.au

**HOBIE CAT EUROPE**

Subsidiary  
Toulon, France  
+33 (0) 494 08 78 78  
hobie-cat.net

**HOBIE KAYAK EUROPE**

Independent Distributor  
Stellendam, The Netherlands  
+31 (0) 187 499 440  
hobie-kayak.com

**HOBIE CAT BRASIL**

Independent Distributor  
Porto Belo, Santa Catarina, Brasil  
+55 (47) 9746-9735  
hobiecat.com.br



**SAILING PARTS & ACCESSORIES**

**INTERNATIONAL 87367236**