



Hobie

PARTS & ACCESSORIES
2009-10 sailboats



HOBIE ALTER. He started off shaping surfboards, he ended up shaping a culture.

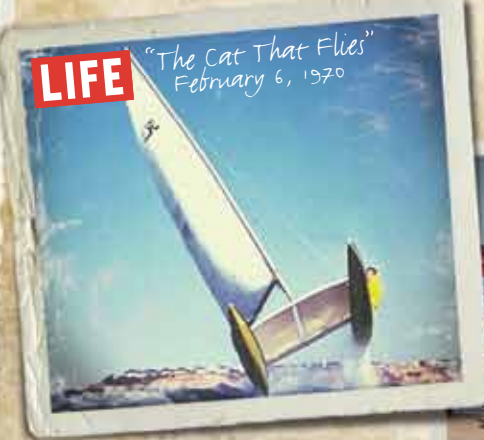

Growing up in Laguna Beach during the 1950s, Hobie Alter always knew he wanted to make life fun. But how could he have known that he would someday make a life out of fun? And in the process forever change the way people play in the water.

It all began on a sunny day at Laguna's Main Beach, when a teenaged buddy of Hobie's asked "What are we going to do with our lives?" For Hobie the answer was simple. He looked out onto the waves, dug his toes in the sand and said, "Nothing where we have to wear shoes, or live on the east side of the Pacific Coast Highway."

The solution was born in his parents' garage, when Hobie decided to apply his love of woodworking to the then-fledgling sport of surfing. Dad backed the Buick out of the way to make room for a shipment of balsa wood, Hobie got out his drawknife and carved out his very first surfboard. Friends soon started dropping by and before you knew it there was no room left for the Buick—Hobie's business of fun had begun.

Hobie and the sport grew together. A couple of years and 40 tons of sawdust later, Hobie opened up Southern California's first surf shop in Dana Point. Then in 1958 Hobie and buddy Gordon "Grubby" Clark began experimenting with new materials, literally inventing the polyurethane foam surfboard (and blowing up the garage in the process). The new boards were lighter, faster and easier to ride than anything else in the water. Suddenly everyone wanted to be a surfer—and every surfer wanted a Hobie.

By the mid-1960s, while the Beach Boys were making records, the legendary Hobie Surf Team was setting them. Hobie's lineup was a veritable Who's Who of surfing greats. Phil Edwards, Joey Cabell, Corky Carroll, Mickey Munoz, Joyce Hoffman, Joey Hamasaki, Gary Propper, Billy Hamilton and Herbie Fletcher are just a few of the champions who sported the distinctive Hobie diamond logo over the years.

Hobie's enduring combination of innovation and meticulous attention to detail would continue to attract the world's best surfers and shapers to the label for the next 50 years. But for Hobie Alter, the fun had just begun with surfboards.

In the late 60's Hobie started messing around in boats. With head designer Phil Edwards, Hobie developed a prototype for a lightweight, fast and easy-to-sail playboat based on the Polynesian twin-hulled catamaran. History soon repeated itself. What the foam Hobie surfboard did for surfing the Hobie Cat did for sailing, introducing a whole new way to have fun in the sun and revolutionizing the industry in the process. In the past four decades more people have taken to the water on a Hobie Cat than almost any other sailboat design. The Hobie Cat models are still the world's best selling cats and it's hard to find a body of water on any continent that doesn't have an active Hobie fleet.

In the years to follow plenty of other ocean innovations emerged from Hobie's fertile imagination: the handy Hobie Power Skiff, a frisky 33' monohull sailer, a 60' ocean voyaging power cat and innovative fishing floats. Life out of the water wasn't ignored, either. Hobie's logo has meant the very best in everything from radio-controlled gliders and skateboards to his world-famous polarized sunglasses and sportswear.

If you use it in or around the water, it seems Hobie has made it and made it better. A perfect example is Hobie Cat's new line of recreational, touring and fishing kayaks, powered by the innovative foot-pedal MirageDrive™—kayaking's first major design change in over 300 years!

It seems incredible that one man's vision could provide so much fun for watermen and women the world over, but in that department Hobie Alter stands alone. Hobie didn't just create toys, he created a way of life, a whole new way of looking at our watery world. The dream born on the beach 58 years ago has become reality not just for Hobie but for new generations of dreamers, all of whom continue to spell fun in the sun, the surf and the sand with a flying capital 

Complete product / page index located on inside-back cover.

*Note: Freight to dealers is not included in pricing.
Freight charges (especially on larger items) may be additional.*

CLOTHING
ACCESSORIES
WET WEAR
LIFE VESTS
TRAPEZE

WING SEATS
SAILS
BATTENS
WIND INDICATORS
TRAMPOLINES
RIGHTING

RUDDERS
TILLERS
HARDWARE
LINE

TRAILERS, STORAGE
MAST STEPPING
BEACH WHEELS
BAGS / PORTS / GLOVES
BOOKS / VIDEO
TOOLS / REPAIRS

SUPPORT / WARRANTY
PART GUIDES
PART LIST
INDEX

5018BK
Black



HOBIE HATS Hats with Hobie "H" in contrasting color and "Hobie" on the side. Mesh versions are breathable and made from 100% Polyester. Others are 100% Cotton Brushed Twill. All but Blue/Gold have embroidered logo raised and back shadowed.

- 5018BL Blue
- 5018BK Black
- 5018GM Gray Mesh
- 5018RM Red Mesh
- 5018TG Tan Green

5018GM
Gray Mesh



5018RM
Red Mesh



5018TG
Tan Green



5018BL
Blue



LID LATCH Don't let that fancy new hat blow away. Secure it to your shirt, life vest, or harness with a Lid Latch.

1553L

LONGITUDE 33



Back

REGATTA



Back

SUNSET



Sleeve

HOBIE "T" SHIRTS All shirts are 100% cotton with screened graphic designs.

- 5126XX Longitude 33 (White)
 - 5127XX Regatta (Black)
 - 5128XX Sunset (Grey)
- (xx = size) md, lg, xl



LICENSE FRAMES
3041 "Fly A Hobie Cat"
3042 "I'd Rather Be Sailing"
3043 "HOBIE" Chrome



HOBIE KEY FLOATS
 Don't lose those keys! Keep a few bucks dry, inside the small compartment, while you sail.
72010 EA



HOBIE CROAKIES Keep your glasses in place! Made from wetsuit fabric that will not stretch or lose shape when wet. Remains secure whether worn normally, raised, or lowered.
1553CR Each



SPORTS BOTTLE Can be used as a water or favorite beverage container. Show your Hobie spirit with the "just right" size (16oz) sports bottle.
71999011 Each

HOBIE SUNGLASSES Hobie® Polarized Sunglasses are designed to improve your vision by eliminating glare, a problem that has been around since the first sunrise. Once you wear Hobie sunglasses you will never want to be without them! By cutting all glare, our sunglasses make it easier to see the wind on the water, the fish in the water and any obstacles in your way. When you put on Hobies it's like a vacation for your eyes! See the complete line of Hobie Sunglasses at hobiepolarized.com

SERIES / MOTION Essential Hobie. Made of rugged injected TR-90 nylon and featuring Lightweight Polycarbonate Hydrorefeactive polarized Lenses, the Motion Series is ideally suited to meet the challenges of active sports as well as everyday wear. This series was designed for demanding sports enthusiasts who are unwilling to compromise on either function or style. Both models we offer here are Matte black with Polycarbonate gray lens. Very light weight.

OCEANSIDE
1563BLK OCEANSIDE

PLAYA
1562BLK PLAYA

HOBIE WATER WEAR

Be more comfortable and extend your kayaking / sailing season by dressing appropriately for the conditions. Mix and match layers to get the comfort you desire. Hobie water wear is designed for both kayaking and sailing needs.



HOBIE SPRAY TOP Designed for active kayaking and sailing. Can be worn with swim trunks or over a wetsuit. Mix and match layers to get the comfort you desire. Spray and wind protection. Beautiful styling and extra durable construction. Construction Features: Neck and wrist seals, Neoprene waist seal, Breathable 5000cm3 nylon shell, Offset chest pocket, Arm patch pocket.

HOBIE SPRAY TOP

3850SM / 3850MD / 3850LG / 3850XL



HOBIE

RASHGUARD for comfort inside your wetsuit and great sun protection when you don't need a wetsuit. This short sleeve design and a high turtle neck style is ideal for any watersport where you need to be more comfortable in your wetsuit, the Lycra material with its 4 way stretch and tight fitting design will let your wetsuit slide on easy when you are getting ready and gives you more freedom when on the water. Raglan sleeve design allows the wetsuit to move so you do not get rubbed and sore – hence the name RASHGUARD – does what it says! The high neck Turtle neck design protects your neck from being rubbed by the suit when in salt water and a sand environment.

UV protection – this top is rated at 50+UPF which gives you the MAXIMUM PROTECTION from harmful UV rays – stopping over 98% of the rays getting to your skin! Ideal for use with board shorts on very hot days in exotic locations – so if you are off to the Caribbean in the winter make sure to pack your Hobie Rash Guard. Construction – Made from 8oz Spandex Lycra with 4 way stretch and feature overlapped seams which are strong and robust.

HOBIE RASHGUARD – SHORT SLEEVE

3851MD / 3851LG / 3851XL

HOBIE RASHGUARD – LONG SLEEVE

3852MD / 3852LG / 3852XL



HOBIE "SHORTY" WETSUIT 2mm/2mm Great comfort for spring-like conditions. Add the Hobie Spray Top to further extend the cool weather comfort range. Add a rash guard for chafe protection. Vertical back zip entry. **FEATURES:** Anti-choke neck, Armortex seat, Lumbar Flex Zone. **CONSTRUCTION:** 100% Dura Flex with mesh chest and back panels, Glued, Blindstitched seams.

HOBIE – SHORTY 2/2 RED/BLACK

3853SM / 3853MD / 3853LG / 3853XL

HOBIE – SHORTY 2/2 BLACK

3855SM / 3855MD / 3855LG / 3855XL

HOBIE "FULL" WETSUIT

HOBIE "FULL" WETSUIT 3mm/2mm For colder days. Add the Hobie Spray Top to further extend the cold weather comfort range. Add a rash guard for chafe protection. Vertical back zip entry. **FEATURES:** Anti-choke neck, Armortex knees, Lumbar Flex Zone. **CONSTRUCTION:** 100% Dura Flex with mesh chest and back panels, Glued, Blindstitched seams.

HOBIE FULL WETSUIT – 3/2 RED/BLACK

3854SM / 3854MD / 3854LG / 3854XL

HOBIE FULL WETSUIT – 3/2 BLACK

3856SM / 3856MD / 3856LG / 3856XL



AQUASEAL MIRAZYME ODOR ELIMINATOR There's nothing quite like the odor of damp sailing gear left in your car trunk for a couple of days. With one application eliminate those odors from booties, wet-suits, dry-suits and the rest of your gear. A 100% biodegradable product made from a blend of 10 highly specialized, light activated microbial elements.

Works by penetrating into pores of fabric, rubber and even hard surfaces to eliminatem odor naturally.

7003 8oz.

MEN	SIZE		HEIGHT		CHEST		WAIST	
	EURO	USA	Ft/In	Cm	In	Cm	In	Cm
	48	S	5'7" - 5'9"	171 - 177	37-40	94-101	30-32	76-83
	50	M	5'9" - 5'11"	175 - 181	39-42	99-106	32-34	81-88
	52	L	5'11" - 6'1"	179 - 186	41-44	103-110	34-36	86-93
	54	XL	6'0" - 6'2"	183 - 189	43-46	108-115	36-38	91-98

HOBIE SHORT-PROFILE VEST by Stohlquist

This side entry design has set the standard for streamlined pfd fit. Cool mesh side panels and reflective accents. Stretchy neoprene adjustable padded shoulders. Roomy mesh pocket with "D" ring for keys. Ventilated mesh side panels. High waistline cut. Huge arm cutouts and a short waist allow excellent freedom of movement. Extra short length allows easy access to trapeze hook while sitting and does not "ride up" around your neck. Adjustable side straps offer enough size variation for many layers underneath or none! SM / MD / LG / XL / XXL (Colors may vary)

S6142XX (xx = size)



S6142
 Sizes (Chest)
 Small 32" - 36"
 Medium 36" - 40"
 Large 40" - 44"
 XLarge 44" - 48"
 XXL Large 48" - 52"

SAFETY TIP!

LIFE VESTS Get a good, comfortable life vest and WEAR IT! A life vest does you little good stored on your boat, especially if you get tossed into the water and away from your boat. Accidents happen and by their nature, they happen when you are not prepared. A life vest can keep you afloat until you can rescue yourself or you can be rescued by others. In the worst cases when injuries or cold water are involved, your life vest can make all the difference! Be sure everyone onboard your boat wears a life vest too! Pass the word! Federal law now requires that all persons below the age of 13 must wear a life jacket while aboard a boat.



NEW HOBIE INFLATABLE PFD

Light weight and comfortable. Ready when you need it - manual inflation. Extremely lightweight and comfortable. Manual inflator allows for swimming, wading and intentional immersion. Available in Red/Grey or Tan/Grey.

S6779RG RED / GREY
S6779TG TAN / GREY

Buoyancy: 29 Pounds
Inflator Type: Halkey Roberts 3F
Primary Inflation: MANUAL
Auxiliary Inflation: Oral
Size and U.S.C.G. Wearer Requirements
Adult Universal: For persons 16 years or older, weighing more than 80 lbs., with chest size of 30 - 52 inches
U.S.C.G. Approval Type: U.S.C.G. Type III
Tough 500D Cordura® Fabric Front Shell
Waist Belt Width: 1"
Zippered External Pocket



STEARNS' CHILD/YOUTH VESTS

Our children's life vests meet the same functional requirements as those for adults. We've selected the, easier to put on, three clip model. These are easy to adjust for different size crews. (Vest color varies, yellow or red)

SBV3120YEL 30 to 50 lbs
SBV3122YEL 50 to 90 lbs

HOBIE HI-BACK MESH by Stohlquist

This front entry vest was designed just for Hobie. The floatation in the back is up high and away from the harness for less bulk down low. There is a mesh panel across the back. Front zip entry for easy on and off. A zipper keeper to prevent the zipper from slipping down when in use. Large mesh pockets on the front for easy storage and access of small items. Stretchy neoprene adjustable padded shoulders. Ventilated mesh side panels. High waistline cut. Huge arm cutouts and a short waist allow excellent freedom of movement. Short length allows easy access to trapeze hook while sitting and does not "ride up" around your neck. Adjustable side straps offer enough size variation for many layers underneath or none! SMD / LXL / XXL (Mango Yellow or Forest Green)

S6143XX MANGO (xx = size)
S6144XX GREEN (xx = size)
S6145XXX ULC* - MANGO

(*ULC - Approved for use in Canada only - xxx = SMD / LXL)



S6143-4&5
 Sizes (Chest)
 S/M 30" - 42"
 L/XL 42" - 52"
 XXL 30" - 54"

S6146 Sizes
 XS/S 30" - 36" (chest)
 M/L 36" - 42" (chest)
 Plus Size 40" - 46" (bust)



NEW WOMENS HOBIE HI-BACK by Stohlquist

Many of the same features as the Hi-Back Mesh, but shaped and contoured specifically to fit Women. Foam layering inside the vest is countoured for a better fit. XXS / MLG / PS (Powder Blue)

S6146XX POWDER BLUE (xx = size)

FULL "AUTO" HARNESS For those looking for added back support and comfort while on the trapeze. Great for spending lots of time on the wire. New spreader ratcheting feature allows easy adjustment of harness around hips as well as quick release feature to get out of harness quickly. Crotchless design with neoprene leg straps, adjustable lumbar support, neoprene covers over side buckles and reinforced patch on the seat. Comes with 10" stainless spreader bar that can only be used with this harness. Colors may vary.

1376XX FULL "AUTO" HARNESS (xx = size) (SM,MD,LG,XL)



FULL "AUTO" HARNESS



CONVERTIBLE HARNESS

CONVERTIBLE HARNESS "Converts" easily from a half harness to full harness with the addition of shoulder straps (included). The all around harness for both racers and recreational sailors where comfort, support and mobility are key.

For the recreational sailor the half harness has enough back support to keep you comfortable on the tramp or the trap.

For the racer, just add the shoulder straps for those long days out on the trapeze where extra back support is needed.

Extra stiff back support, padded leg straps / shoulder straps, neoprene covers over buckles and a 10" stainless spreader bar.

It all adds up to keeping you comfortable and having fun on the water. Shoulder straps included with harness. Colors may vary.

1378XX CONVERTIBLE HARNESS

(xx = size) SM [Small/Medium], LG, XL)



SKIPPERS HARNESS

SKIPPERS HARNESS The harness for both racers and recreational sailors where comfort and mobility on the trampoline are most important. For the sailor who spends less time on the trapeze or prefers to "sit up" rather than lean out more. Unique leg strap design combining neoprene and webbing to eliminate chafe.

Neoprene covers over side buckles and a 10" stainless spreader bar.

Reinforced seat. Colors may vary.

1388XX SKIPPERS HARNESS

(xx = size) (SM, MD, LG, XL)



SPREADER HOOK 10" wide black painted, stainless steel hook spreads the load on the waist straps of any harness. Use to update older harnesses for better comfort.

13825



COATED TRAP WIRE SETS Highest quality aircraft stainless wire coated with UV tolerant black or white vinyl coating for all of our wire products. Molded nylon handles are installed at the right place for easy in and out maneuvering. Also available in kits which include the trapeze shock cord.

- 1471W** H16,17,SPORT Pair-White
- 1472W** Above w/ Shockcord (16 only)
- 1471B** H16,17,SPORT Pair-Black
- 1472B** Above w/ Shockcord (16 only)
- 1473W** H18 Pr (1 side)-White
- 1474W** Above w/ Shockcords
- 1473B** H18 Pair (1 side)-Black
- 1474B** Above w/ Shockcords
- 1475B** H14 Pair-Black
- 1476B** Above w/ Shockcord
- 1478B** Getaway Pair-Black

WAVE / GETAWAY TRAPEZE KITS Add a trapeze system to your Hobie Wave or Getaway. Complete with wires (pr), return bungee system, lines, blocks, locks and dog bones. Just add a trapeze harness and you are flying! Wave kit includes adjustment lines with internal shockcords and hull attachment hardware.

- 38140001 WAVE TRAPEZE KIT**
- 37140001 GETAWAY TRAPEZE KIT**



MOLDED TRAPEZE HANDLE Strong and comfortable molded grips are contoured to fit the hand. Wire guide shank keeps wire from cutting between the fingers. This is the "standard" handle on all wires.

2011 Each



REPLACEABLE TRAPEZE HANDLE This simple, rubber padded, all aluminum handle can be installed on any 3/32" wire without disconnecting anything. Just screw the 2 halves together and it's ready to use.

2010 Each

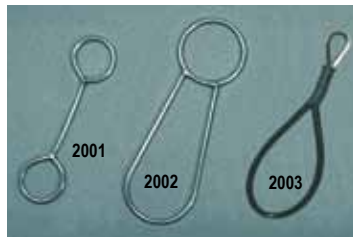

TRAPEZE DOGBONES

These dogbones feature high grade 316 stainless steel with welded construction for superior strength.

- 2001** Standard
- 2002** Keyhole Shape
- 2003** Flexible Dogbone



J & H HANDLES Open design combination dogbone/trapeze handle makes getting hooked and unhooked very simple. Choose a different color for the skipper and crew for easy identification.

- 2004BLK** Pair-Black
- 2004WHT** Pair-White

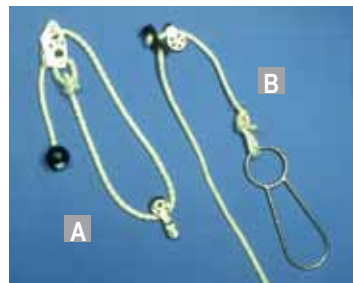

A DELUXE ADJUSTABLE TRAPEZE RIG

The original trap rig. Adjust your position while you are out on the wire. V-Jam pulley system allows you to compensate for that puff or lull in the wind without coming in off the wire. Comes complete with all blocks, ropes, and swivels needed for one pair.

1203 w/o Dogbones

B STANDARD ADJUSTABLE TRAPEZE RIG

The standard kit includes blocks with removable sheaves, rope, rope locks and stop washers. Can be purchased with #2002 dogbones or without dogbones (for possible use with J&H Handles.)

- 3101** w/Dogbones
- 3102** w/o Dogbones

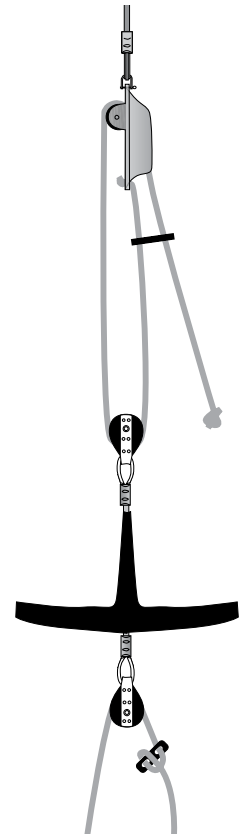

DOUBLE ADJUSTABLE TRAPEZE

Adjust the level of the entire system, ring and handle. Always have the trapeze "T" handle at the proper comfortable to reach level. Crew can move fore and aft to extremes and maintain efficient and comfortable trapezeing level. Bungee gives constant upwards pull on trapeze ring to ensure that you stay hooked up. Stock trapeze wire must be shortened by approx. 8". Order trapeze rings and bungee separately.

1204 Kit



HARKEN MICRO FIDDLE BLOCK

Superior quality Micro Fiddle Block with V-Jam cleat from Harken. For use with 7/32" to 5/16" (5mm-8mm) line to make adjustable trapeze system.

H244 Each

RAIL RUG Provides excellent footing when out on the trapeze. Kit includes a high quality grade of carpeting which absorbs less water, keeping weight down and reducing mildew. Also included in each kit; industrial grade contact cement (much better than the hardware store variety), brush and easy to follow instructions. For all catamarans.

1671BLK H14/16-Black

16703 Contact Cement-Pt



NEOPRENE RAIL KITS Provides excellent footing while out on the trapeze and cushions the non-skid areas. Eliminates abrasion on your skin or clothing because it sheds sand. Zero water retention. Made out of 1/8" thick knobby black neoprene. Kit includes industrial grade contact cement, brush, and instructions for easy installation on any boat. Race strips are for hull decks rear of trampoline frame. H16 kits are full wrap around as used in Worlds boats.

16706 H14 / H16 Kit

16707 Race Strips-Pair

16708 H18 Kit

(H18 Die Cut - Shown Above)



FOOT STRAPS / CARRYING HANDLES

Stop that unexpected "JOURNEY TO THE BOW." Add foot straps for the skipper and crew for security on those screaming reaches. Also, just right for lifting the boat instead of dragging it up the beach.

1241 Pair



NON-SKID Low profile, white tape provides excellent foot grip for trapezing. Blends in with standard white hull color to the point it is nearly invisible. Tape is adhesive backed for easy installation.

16713 2" x 20'



REMOVABLE SHEAVE TRAP RIG BLOCK

This is the block we include in our basic trap rig kits. No need to cut wires to install this block. Simply remove the clevis pin that acts as the sheave axle, slide the sheave out of the frame, place the frame through the trap wire thimble and reinstall the sheave.

3103 Each



TRAP STAY An easy answer to wandering wires and "who's whose" confusion on the Hobie 16. Mount these little keepers under the side rails and drop the shockcord in. Works great to keep everything in its place.

176 Pair



ROPE LOCK Use on trapeze rope to make your trapeze system adjustable.

61530000 Each

TECH TIP!

TRAPEZING While sitting on the edge of the boat, attach the trapeze dogbone to the trapeze hook on your harness. Grab onto the trapeze wire's handle with your forward hand. Place your other hand on the hull behind you. Using your hands for balance ease yourself off the side of the boat and place your forward foot on the rail. Push yourself away from the boat with your rear hand and forward foot till you can place the rear foot on the rail. Stand on the rail of the boat with your weight on the trapeze wire. Keep your forward leg more rigid and aft leg slightly bent. This position will help keep you from falling forward.

While learning to trapeze, beginners should set their trapeze height just at the rail level or slightly above. This will make it easier to get in and out. Keep your legs spread several feet apart for balance. As you get used to the feel of trapezing you can begin to lower your trapeze height and move your legs closer together. Once you become an expert on the trap wire, your proper body position should be parallel to the deck with your feet right next to each other.

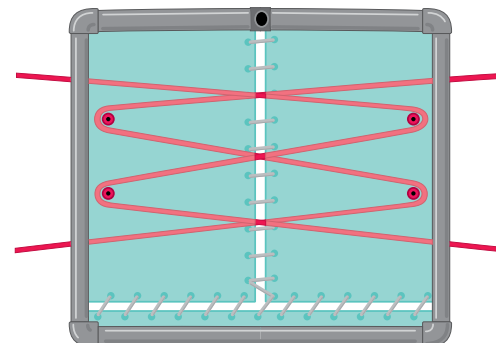

TRAPEZE RIG RETURN SYSTEM Custom system with double-length shockcord reduces the unpleasant forward pull when you're trapped out off the stern on a reach. It also prevents breakage of the shockcord when you stuff a lee bow and the crew takes a spin around the forestay. All required hardware is included.

14709 H16 Kit

PERFORMANCE AND COMFORT!

GETAWAY WING SEATS These are perfect for lazy day sailing, relaxed hiking out on your Hobie Getaway or for high performance fun. Turquoise vinyl mesh covers aluminum extrusions that are contoured to make a very comfortable back rest or seat. Remove two quick pins per side and they rotate in for trailering.

37001000 Wing Assembly with seat cover

37971058 Replacement Cover - Turq Mesh



HOBIE GETAWAY



HOBIE WAVE

NOTE: ADDITIONAL FREIGHT CHARGE ITEMS Items shown on this page will incur additional freight charges from the factory that are not included in pricing shown.

WAVE BACK RESTS These simple to install Back Rests are perfect for lazy day sailing on your Hobie Wave. The last word in sailing comfort. They plug into the front and rear cross beams. On or off in 3 minutes or less.

38040011 Back Rest, Set

38041001 Replacement Cover, Backrest Pad (Blue)

8020181 Fast Pin (ea.) for quick release of back rests.
Four required. Sold separately.

HOBIE SAILS HOBIE SAILS



BRAVO - WAVE - GETAWAY

BRAVO
90990010 SAIL, BRAVO MAIN SPIRIT

WAVE
38991000 SAIL, WAVE MAIN WHITE
39991000 SAIL, WAVE MAIN RESORT WHITE*
38991075 SAIL, WAVE MAIN SPIRIT
38991076 SAIL, WAVE MAIN SPIRIT W/ZIP
38992010 SAIL, WAVE JIB WHITE
38992071 SAIL, WAVE JIB TURQ
38992007 SAIL, WAVE JIB YELLOW

GETAWAY
37991075 SAIL, GETAWAY MAIN SPIRIT
37992071 SAIL, GETAWAY JIB TURQ

SEE PARTS LIST FOR ALL OTHERS



14 - 16 - 18

HOBIE 14
10990010 SAIL, H14 MAIN, WHITE
10991086 SAIL, H14 MAIN, CORONADO
10992511 SAIL, H14 JIB, WHITE
10992081 SAIL, H14 JIB, TURQUOISE

HOBIE 16
20991011 SAIL, H16 MAIN, WHITE
20991086 SAIL, H16 MAIN, CORONADO
20991085 SAIL, H16 MAIN, SMOKE
20991991 SAIL, H16 MAIN, SPECIAL ORDER
20992010 SAIL, H16 JIB, WHITE
20992071 SAIL, H16 JIB, TURQ
20992081 SAIL, H16 JIB, SILVER
20992086 SAIL, H16 JIB, RED
20992991 SAIL, H16 JIB, SPECIAL ORDER

HOBIE 18
60991011 SAIL, H18 MAIN, WHITE
60991086 SAIL, H18 MAIN, CORONADO
60992011 SAIL, H18 JIB, WHITE
60992071 SAIL, H18 JIB, TURQUOISE



JIB KITS

TECH TIP!

ROLLER FURLING JIBS Just roll the jib up when you come into the beach or de-power if it gets too windy. Want to fly a spinnaker? The furling systems work great for easy spinnaker flying. A roller furling jib system can increase the life of your jib by avoiding flogging the jib material while on the beach or between races. Allows you to store the boat without lowering the jib (jib "snorkle" cover suggested). Kits available for the Hobie 20, 17, 16, 14.



HOBIE WAVE JIB KIT Bring your Wave sailing up a level. More sail area equals more speed and performance. The Wave jib accelerates learning and encourages participation of your crew in sailing. Our jib hardware kit comes complete with bow spreader pole, all the nuts, bolts, and blocks required. Order Jib separately.

38999001 Wave Jib Hardware Kit

38992010 Wave Jib, White

38992071 Wave Jib, Turquoise

38992007 Wave Jib, Yellow

JIB KIT SPARE PARTS

38999021 Bow Spreader Pole Only

38120041 Tang for Bow Spreader Pole

HOBIE 14 TURBO KIT (JIB & FURLER)

Add Turbo power and enjoy the excitement of trapezing from the 14 with the complete Turbo kit (comes complete with trapeze and jib sheeting hardware). A dolphin striker is required for trapezing. If your boat is pre-1982, order the upgrade kit for new length shrouds, chain plates and tramp jib grommets. Order jib separately.



80200000 Turbo Kit w/ Hobie Furler

80200020 Turbo Upgrade Kit (pre-'82)

80200010 Dolphin Striker Kit (pre-'82)

10992511 White Jib

10992081 Turquoise Jib

HOBIE JIB FURLER SYSTEMS Just roll the jib up when you come into the beach or de-power if it gets too windy. Speed, excitement and convenience all rolled into one!

HOBIE 16 FURLER KIT Order a new furling jib separately or requires a re-cut of the standard jib.

8001 KIT W/ Hobie Furler

8002 White Furling Jib

HOBIE 20 FURLER Complete jib furling kit. Uses standard H20 Jib. No jib modification needed. Includes patented Hobie furler drum, forestay, halyard system and all needed hardware and fasteners.

48921001 H20 Jib Furling Kit

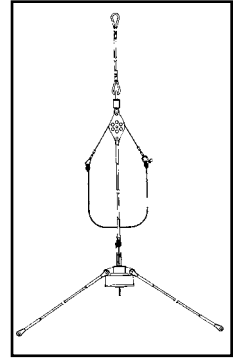

HOBIE 17 FURLING JIB (SPORT CONVERSION) Add the Sport roller furling jib and bow spreader pole to your Hobie 17 for extra performance and easy tacking. You'll be faster upwind, reaching, and tacking downwind. No more 16's passing you down wind in light air. Order jib separately.

52995610 17 Sport Jib Hardware Kit (with spreader)

52992006 White Jib

52992023 Special Order Color Jib



SPORT "BOOMLET" SAIL FOOT When the boom is removed, it is much easier for your passengers and crew to travel from one side of the boat to the other while tacking or jibing. 1995 and newer Hobie 17 "SE" race boats can easily be converted to a "Boomless Sport" by adding the "Boomlet".

52722011 '95 and newer SPORT "Boomlet"

17 SPORT TO 17SE CONVERSION Have a Sport 17 and want to race? This kit includes all parts needed to convert a 1995 or newer 17 SPORT to the race SE version. Included are the boom, gooseneck fittings, mast rotation parts and forestay assembly. Older Sports equipped with HARKEN main traveler track may need to convert to the class legal "Tracker" traveler system (not included). Pre '95 Sports require purchase of new main sail.

52995640 Sport to 17SE conversion kit



SPINNAKERS



HOBIE 16 / SNUFFER SYSTEM



HOBIE TIGER / SNUFFER SYSTEM

SPINNAKER SYSTEMS Quick setup, ease of use, and maximum performance were just a few of the design criteria. Our spinnaker kits provide better sail control with fewer lines. The Spinnaker Pole and Rig Kit contain all the equipment and lines to control hoisting, setting the tack and sheeting the Spinnaker. Just pull on the halyard ... the sail is hoisted and the tack is hauled out to the pole end!

HOBIE WAVE

38999000 WAVE Pole & Hardware Kit

38999052 WAVE Spinnaker (Call for available color)

HOBIE 16 Trumpet Snuffer Spinnaker System

20999020 H16 Pole, Snuffer, Spinnaker & Hardware

F16032110 H16 Spinnaker (Colors vary)

HOBIE 18/SX18

60999000 H18/SX18 Pole & Hardware Kit

68999004 Spinnaker (Call for available color)



HOBIE WAVE

TECH TIP!

SPINNAKERS Flying a spinnaker is one of the great thrills of sailing. And one of the great challenges for both skipper and crew. Spinnakers increase downwind speed while actually creating lift at the bows! Few things compare to the thrill of running off the wind under a huge and colorful spinnaker! Spinnakers require special rigging. A survey of the products on these pages will give you a good idea of the options available.

BATTENS



UNIVERSAL BATTENS Availability of the correct batten has often been a problem. The various models of Hobie Cats all use different batten and taper lengths. In earlier years, each model Hobie used a different color batten. The battens were all the same specification, just a different color. We now stock only white sail battens for all models.

Complete battens sets, cut and tapered to specification length are available for some models. Individual battens are filled from stock as shown in the following table. Batten numbers start from the bottom batten in each sail (#1). Battens are trimmed by purchaser to exact length. Stock batten lengths are shown in the illustrated Hobie parts pages 49-70. (T)=Tapered

82010001 Batten (max 107 7/8", min 87 5/16") *not tapered*

82020001 Batten (max 82 3/8", min 72 1/8") *not tapered*

82030001 Batten (max 90 1/8", min 46 1/8") 27" *taper*

82040001 Batten (max 42 11/16", min 39 1/16") 27" *taper*

82060001 Batten (max 100 9/16", min 67 7/8") 27" *taper*

82070001 Batten (max 67", min 51 3/4") *not tapered*

82080001 Batten (max 43 3/4", min 24 1/8") *not tapered*

	82010001 107 7/8"	82020001 82 3/8"	82030001 90 1/8"(T)	82040001 42 11/16"(T)	82060001 100 9/16"(T)	82070001 67" (J)	82080001 43 3/4" (J)
WAVE		1,2,3				4	5
H14	1,2		3,4,5	6			
GETAWAY	1,2		3,4,5,6,7				8
H16M	1,2,3,4	5,6	7	8			
H16J						1,2	3,4
H17			3,4		1,2	5	6
H18	1,2,3,4,5		6,7,8	9			10
H18SX	1,2,3		8		4,5,6,7		9
H21SE	1,2,3		4,5,6				7



SUPER JIB BATTENS Work your jib with greater ease. Light and limber fiberglass battens virtually eliminate hangups when tacking the Hobie 16 and give your jib superior shape in light air when you need it most. Increases drive compared to the stock jib battens. Not class legal for racing but so nice to use the rest of the time. Complete with end caps.

122 Set of Four



JIB BATTEN HINGE Solution to jib hangup when tacking the Hobie 16. Easy to install, these allow the jib battens to pivot on contact with the mast and to snap back straight after the tack.

20390001 1 Hinge

20392001 4 Hinges

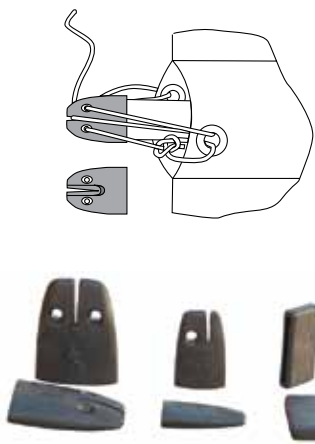

HOBIE CAT LEACH & LUFF CAPS

Release the batten tension whenever you store your sails. This will prolong the life of your sails. Luff caps and adjustable leach caps are made of high strength, ultra-violet tolerant Delrin®. No knots to tie or untie. Tension adjustment lines not included. Sold individually. 4:1 mechanical advantage allows finer adjustment than does Trentec 2:1 caps.

- 11323000** Main Leach
- 21333000** Jib Leach
- 11322011** Main Luff Tip



TRENTEC LEACH CAP SETS

No knots to tie and untie. Guaranteed slip proof. Includes lines.

- 1521** H14 Kit
- 1522** H16 Main Kit
- 1523** H18 Kit
- 1531** H16 Jib Kit
- 1529** Foam Batten Cap
3/4" H20/P19

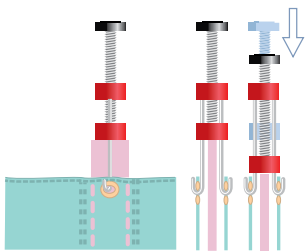

BATTEN TENSIONER Talk about precision batten adjustment. This screw thread adjuster allows as fine an adjustment as you want. It clips to the sail (at the batten tie string grommets) and pushes against the end of the batten. No batten cap is required. Use with Trentec Draft Gauges and always know exactly what your sail shape (due to batten tension) will be.

- 1528** Each



TRENTEC LUFF CAPS Prevent "poke through"! These Trentec caps slip over the luff (front) end of your mainsail battens to increase the life of your sails and of the batten-pocket protectors. Each cap is molded at the angle to match the angle at which the batten meets the luff.

- 1561** H14 Kit (6)
- 1562** H16 Main Kit
- 1563** H18 Kit
- 1566** H16 Jib Kit



TRENTEC DRAFT GAUGES Use these coded, adhesive backed vinyl strips to calibrate your batten tension for each and every wind condition. Scale calibration mathematically calculated for each batten to assure consistent batten tension.

- 1541** H14 Kit
- 1542** H16 M & J Kit
- 1543** H18 Kit



TECH TIP!

SAIL CARE At the end of the day most cat sailors roll their sails on the lower batten or around the boom. If you do, roll your sail loosely. Any sharp bends in the sail cloth break down the resin coating on the cloth. This weakens the cloth leading to premature stretching or pin size holes that will grow. You can lengthen the life of your sails with careful handling and by using some of the special accessories we offer. The various tapes and sleeves we offer are all intended to protect the sail from sharp edges and abrasive areas on the boat that wear away at the sail's fabric until suddenly there's a hole and next a tear. It's never too late to slow down wear and tear.



BATTEN POCKET ANTI-CHAFE TAPE

Your sail is expensive! Save it from an early grave with space age tape that affords ultimate protection to the batten pockets—where the shrouds eat through the cloth. Even covered shrouds don't postpone this for long! This remarkable material has up to 10 times the abrasion resistance of steel and yet this transparent tape will not hide your sail's colors or leave you with a gummy, unsightly residue that Duct tape and other tapes will.

GREAT FOR USE ON ALL FULL-BATTENED SAILS!

- 1491** H16/20 Main
- 1492** H14/17 Main
- 1493** H18 Main 3
- 1494** Tape per foot



SAIL CHAFE PROTECTOR SET From Harken. A split roller predrilled to fit up to 3/16" diameter wire. Replaces diamond wire rollers.

- H285** Set



SAIL REPAIR TAPE Don't get caught with your sails down! Extra strong, Rip Stop white tape for temporary on-the-spot repairs to torn sails, canvas, even foul weather gear. Keep a roll in your toolbox for emergencies.

- 1662** 2" x 25' Roll



SPREADER BAR END COVERS

Smooth and resilient vinyl spreader bar end covers protect the jib luff from wear and tear on cotter keys and sharp edges. A real sail-saver.

- 3262** Pair



JIB PROTECTOR KIT Install hard plastic covers specially designed for cotter keys and Hobie 18 and 20 spreader bar ends. No slitting or taping required.

- 1512** H18 Kit
- 1513** H20 Kit



SAIL REPAIR KIT Takes care of emergency repairs to sails and trampolines. Kit includes 3 different weights of thread, 3 sizes of needles, and 6" x 6" white sail cloth.

- 1665** Kit

TECH TIP!

WIND INDICATORS When sailing downwind, without a bridle fly, you can't gauge apparent wind direction without looking up and taking your attention off the action (boats crossing) on the water. The light weight indicators are most suitable in moderate and stronger wind conditions. Not severely affected by wave action, they work well tacking downwind. They are both durable and sensitive. The heavier Telo Cat is the most durable. It stands up to crashing waves sailing in rough conditions. Mast head indicators excel at detecting wind shifts and velocity changes. The bridle fly is the best when sailing off the wind, especially in light and moderate air.

TELO CAT WIND VANE Tough molded plastic vane. Rugged heavy duty stainless steel shaft with Teflon bearings. Tacking arms can be set to desired vane angle for optimum performance setting. Easy removal—no tools required. Fits Hobie 14/16.

377 Telo Cat

378 Vane Only



HOBIE BRIDLE FLIES Durable Mylar wind vane with excellent light to moderate air response. Adjust your sails to the apparent wind angle. A must for best downwind sailing performance. Stainless steel mounting shaft. Quick removal for trailering.

CM7703 Std Bridle Vane

CM7704 Replacement Vane

CM7705 Hobie Furler Adapter



BLACK BEAUTY Black tell tale that is highly visible on the leeward side of light colored sails. Perfect for white dacron and neon mylar sails.

335 Set of 14



AIR-FLOW TELS Trim your sails for optimum performance. Attached air flow over sails is critical. Air flow directions are indicated by these tell tails. Made of light weight rip stop nylon (Red / Green). Attaches to sails with waterproof adhesive disks.

334 Set of 14



DWYER WIND METER Two scales are provided for maximum readability and accuracy. To operate, hold at eye level with back of the unit to the wind. The position of the white ball in the tube indicates wind speed in miles per hour. Wind Meter comes in waterproof plastic case with maintenance kit and instructions.

330 Each

WINDTRONIC2 WIND METER The cup principle eliminates the cumbersome need of orienting the device as measurements are obtained irrespective of wind direction. Clearly Legible Display, The large LCD display shows the following readings: Current wind speed, Max. wind speed (MX) Average wind speed (AV) Bar graph of current Beaufort values. Selectable Units: By a simple push of a button you may select one of the following units: KM/H (Kilometers/Hours), KTS (Knots), M/S (Meter/Second), MPH (Miles/Hour). Manual or Stationary Operation: An integrated tripod thread allows you to make temporary stationary use of Windtronic 2. Accurate Readings: A combination of precision mechanics and quartz-controlled electronics guarantees the high level of accuracy over the entire temperature range. Minimal Energy Consumption: A standard lithium battery will supply your wind meter with power for approximately 10 years. After that time, you can simply replace the battery yourself. Precision made, the Windtronic 2 is a German anemometer. It gives readings for current, average and maximum wind speed in a choice of Km/h, mph, m/s or knots with a Beaufort scale on the left of the screen. Water resistant.

Comes with belt carry case. 2 year warranty.

278 WINDTRONIC2 WITH BELT POUCH

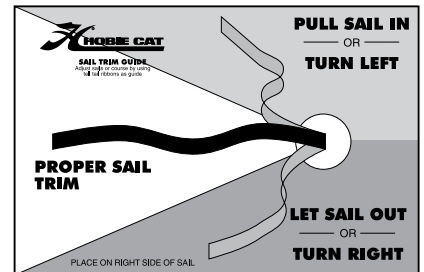
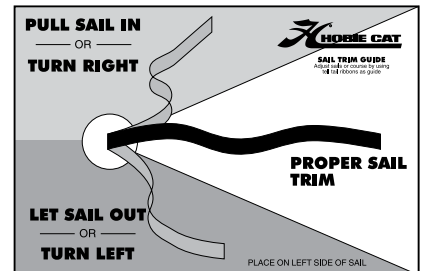

Hobie

To order from your nearest Hobie Cat dealer
U.S.A. hobiecat.com 1-800-HOBIE-49
Australasia hobiecat.com.au 1-800-4-Hobie

TRAMPOLINES

HOBIE TRAMPOLINES We've got what you want and it's in living color! All of our HOBIE trampolines are heat welded rather than stitched for the ultimate in longevity and easy maintenance. There is no potential of UV degradation of thread or loose thread unraveling an entire seam. This is a HOBIE exclusive, longer lasting by far!! All include halyard pocket. *Note: Hobie Class Association racing requires the Hobie Cat factory supplied trampoline.* **SEE PARTS GUIDES AND PARTS LIST FOR TRAMPOLINES & AVAILABLE COLOR OPTIONS.**



HALYARD POCKET ON ALL TRAMPOLINES



TECH TIP!

HOBIE TRAMPOLINES Hobie trampolines are the best! We use heat welded vinyl in all of our trampolines to create the strongest and longest lasting trampolines on the market! Others stitch their trampolines. That stitching breaks, unravels and rots! It also weakens the trampoline material by poking holes in it! With heat welding, this does not happen! All of our trampolines are triple reinforced at all stress points including the corners and webbing grommets. We make our trampolines in either solid vinyl or mesh vinyl. Our vinyl trampoline is dryer, while the mesh will allow the wind and water through.



TRAMPOLINE DRINK HOLDER

Hobie Cat put drink holders into the 21 Sport Cruiser wing tramps and Wave SE trampoline. You can add drink holders to your trampoline too! Requires a hole cut into the trampoline and stitching. Can be done by a sail loft or upholstery shop.

1125 Drink Holder



HIKING STRAP WEBBING

Replacement webbing for hiking straps (by the yard).

8001821 Webbing strap

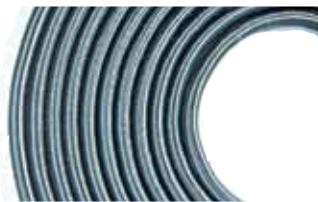

TRAMP LACING KIT Many sailors prefer lacing their trampoline with shock cord. This kit includes three pieces of 3/8" nylon covered black coated nylon shockcord and 12 clamping rings. Fits the H14, 16, and 18. Not shown.

2064 Kit

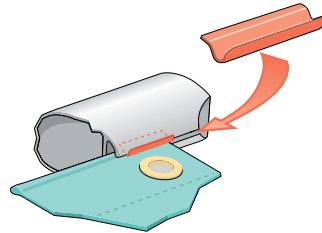

TRENTEC™ TRAMP CLAMP™

Prevents trampoline from pulling out of aluminum extrusion. Increases trampoline life. Minimizes chafing of the trampoline at the critical stress points.

2066 Set

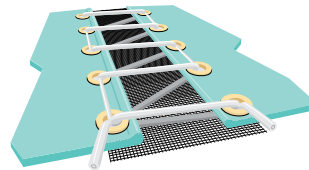

MAINSHEET OVERBOARD PREVENTER

This neat little piece of mesh laces into the existing tramp grommets, filling the center gap that the mainsheet is forever falling through. Existing lacing does not need to be undone. Kit includes line for lacing the preventer.

2067 66 inches

TRAMPOLINE DOUBLE GROMMET KIT

Hobie Cat doubled the number of grommets across the rear of the trampoline in 1983 to reduce stress and strengthen the trampoline. This kit includes 24 spur grommets and installation tools. Buy an additional 24 grommets to do the center lacing.

2061 Complete Kit

2062 24 Grommets

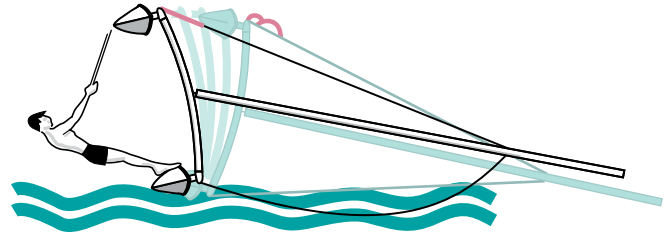
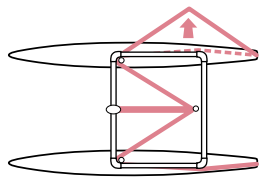
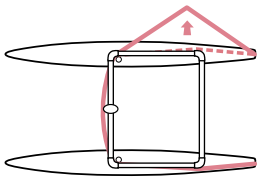

EASY RITE Internal shock cord recoils this righting line automatically. Made from 1/2" hollow braid line with internal shockcord. It requires no blocks or shackles. Installs in minutes without tools. Also functions as crew safety line. Our best selling righting system.

- 30105** H14/16/17
- 30106** H18/21
- 30108** H20
- 30109** Getaway

EASY UP Favored Hawaiian style righting line system and trapeze safety line. (H14/16 only.) Retracts fully—it's there when you need it and out of the way when you don't. No tools required to install.

- 30101** H14/16
- 30102** H18

THE UPRIGHT SOLO RIGHTING SYSTEM The Upright installs easily. No holes to drill, no measurements are needed. Attaches in five minutes to the existing shroud adjusters with a pair of pliers. Racing rules allow carrying the Upright for emergencies, but it may not be used while racing. The Upright is designed for a single reason, to make sailing your small catamaran safer. The 1266 for the *Hobie 20/21 includes Hyfield levers.

- 1263** H16
- 1264** H18/20
- 1265** H17

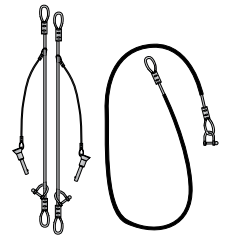

ANTI PITCH POLE HYDRO FOIL A simple bow plane that attaches to the bow tang bolt. As the bow starts to dive the bow plane's 55 square inches of surface comes in contact with the water and halts the submerging of the bow before the deck goes under water. Easy to install or remove for racing. Makes sailing a lot more fun for the recreational sailor.

- 30110** H14/16 Pair



RIGHTING BUCKET Simple, easy to carry, and easy to use. Comes complete with no-rot canvas bucket, premeasured line, shoulder pad (not shown) and snap. The righting bucket holds as much as 150 pounds of water to assist your body weight to right your catamaran.

- 30107** Kit



SHROUD EXTENDER Tension and de-tension shrouds easily for the "perfect" rig for each wind condition. Use in conjunction with "shroud extending" righting systems for complete re-tensioning while out on the water. Requires shrouds be shortened. Check class rules for racing.

- 10049** Each

TECH TIP!

RIGHTING YOUR HOBIE On that reach...flying through the air and water then...WHAM!!! Your Hobie Cat has forced you to swim instead of sail. Not really what you had in mind? If you have planned ahead you will be up and sailing again quickly. Whether sailing single handed or with a few friends, righting your boat can be quick and easy...

First, preventing your mast from becoming one with the bottom, or "turtling" is a priority. We at Hobie have designed mast floats to help keep your Hobie Cat from becoming a 'mudhen'. The floats attach to the top of your mast and will prevent the mast tip from sinking.

The next objective will be to get back to sailing! Righting systems vary a bit, but the theory is the same. A line is attached to your Hobie, thrown over the hull in the air and then weight (yours and or your friends) is used to lever the boat back to an upright and sailable position.

After you have checked that everyone is OK, turn your hulls and mast into the wind (see diagram) and uncleat your sails. You and your friend now need to congregate on the hull that is in the water. Grab the righting line, lean away from the trampoline and get as close to the water as you can. Try to stay out of the water. If you don't have enough body weight to right the cat we have the Righting Bucket! Just attach it to the boat, with the hook that is provided, throw over the upper hull and fill the bucket with water! With the bucket strap over your shoulder, lean your weight out from the boat. The bag comes clear of the water and up the cat will come!! Grab the dolphin striker or crossbar as it comes up, climb aboard, sheet in and GO!

Tipping your Hobie over can be a great way to cool off and enjoy the water... try it! It's excellent practice for when you weren't planning to go for a swim but your Hobie decided that you needed to cool off!

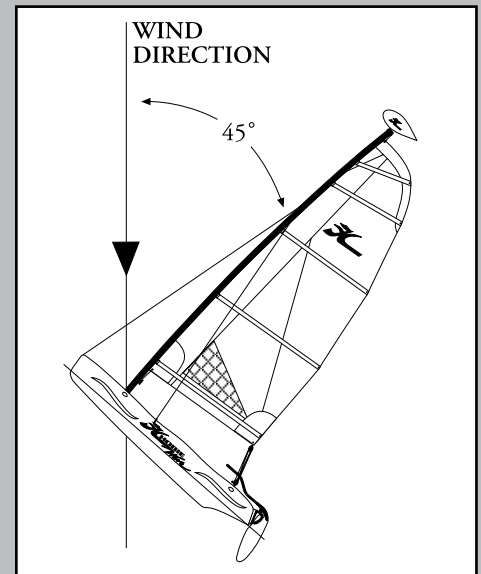

UNIVERSAL MAST FLOAT "Mama Bob" Helps to prevent turtling. Displaces 59 pounds of water to help keep the mast from going full turtle (mast straight down). The Hobie mast float will give you the time you need when preparing to right the boat without the worry of going turtle. It also helps prevent damage to your rig and sails that can be caused if the mast head contacts the bottom when capsized. This streamlined float is shaft mounted to the side of any mast and is easily removed for racing or trailering. This float is contoured and held in alignment with the mast for minimum drag while sailing. Includes shaft mount hardware and fasteners.

30112 Fits all cats

MAST FLOAT "Baby Bob" Designed by the Hobie Cat team to offer the safety and security of mast head floatation while limiting the resistance (drag) through the air. The Hobie mast float can give you the time you need to prepare to right the boat without the worry of going turtle (mast straight down). This also helps prevent damage to your rig and sails that can

be caused if the mast comes in contact with the bottom when capsized. This mast float is standard on all Hobie Waves. It is fixed in position to the mast head and rotates with the mast. Displaces 32 pounds of water and measures 1/2 cubic foot in volume. Bracket mounting allows easy removal for racing or trailering. Kit includes mounting brackets and fasteners.

30115 Wave, H14, H16

MAST FLOAT "Mama Bob" Float (Standard on the Getaway) offers more floatation volume while using the same mounting system. Displaces 59 pounds of water (just under 1 cubic foot in volume). Mama Bob has nearly the same vertical dimension as the Baby, but it is wider. More volume further inhibits a boat from going turtle when capsized in rough and windy conditions. Kit includes mounting brackets and fasteners.

30119 Getaway

HOBIE EPO²

HOBIE CAT COMPANY - USA / AUSTRALIA

EPO² RUDDER BLADES The return of the famous EPO!! The legendary rudder shape but improved. Hobie Cat took the original EPO foil and digitized it to weed out imperfections in the original design. We also improved the trailing edge for better "out-of-the-box" performance. We developed the EPO² rudder blade as the next generation performance rudder blade for the 14, 16, 17, 18 and 20. With this proven foil shape and a fine trailing edge, the EPO² offers reduced cavitation and hum with smoother, more forgiving control. The EPO² rudder is stiff where it counts due to its hand laid fiberglass construction incorporating extra cloth for longitudinal stiffness. We have placed extra glass in all the right places to ensure that it is tough enough for the most demanding sailors using extreme mast rake. You will experience supreme performance and handling not found with other rudder blades. Black Carbon: Gucci looks, stiff and light weight.

EPO² CARBON EPOXY



The EPO Story: Years ago when Hobie Cat was part of the Coleman Company we had a sister company which built the original EPO rudders for us. It was a highly advance production process. The EPO was very popular, handled great and was very durable. Sailors LOVED them! In the late 80's the EPO production capability was lost to us. We are very pleased, as many a sailor will be, that the EPO has been re-born!

20490020 EPO² Black Carbon Epoxy blade – ea.

20493000 Std Nylon Plastic blade, White – ea.

TECH TIP!

RUDDER RAKE

Excessive weather helm (when you must pull hard on the hiking stick to keep the boat from turning towards the wind) can be corrected by cocking the rudders farther (forward) under the boat. If you have too much lee helm (very little pull on the hiking stick, with the boat tending to turn away from the wind), this is corrected by unscrewing the adjustment and cocking the rudders back (aft). The amount of rudder rake needed depends on how far back the mast is raked and how much weight is being carried. The biggest problem with rudder adjustment is when a skipper changes the blade adjustment screw without reseating the cam plate in the upper casting. Even a very minor adjustment to the rudder could cause the cam to lock partially rotated, dramatically reducing the kick-up resistance. That means every time you make a blade rake adjustment, you must also reseat the plate AFTER you have finished adjusting the blade rake. There are three very important adjustments that should be made to the rudder assembly.



1. The rudder rake screw which adjusts blade angle.
2. The cam plate bolt which holds the blade forward.
3. The cam tension screw which adjusts kick-up tension.

When system adjustments are made improperly, the system won't work right. You must follow these steps in order!

1. Lift the rudder arm to unlock the assembly.
2. Using an allen wrench, adjust the rudder rake screw to give the desired rudder blade angle (rake).
3. Make sure that the blade is seated forward against the adjustment screw, loosen the cam plate bolt and lock down the assembly. Slide the plate back a little and then forward as far as it will go up into the cam. Retighten the bolt with a 1/2" socket.
4. Adjust the kick-up tension screw with a screw driver. You can calibrate the tension with a fish scale by making a loop of rope and putting it on the rudder blade about 24" down from the front bolt hole. Hook the scale to the loop and pull. Factory kick-up tension is set between 18-22 pounds.



DIE CAST GUDGEONS Standard on current production Hobie 16s, these die cast aluminum gudgeons are now available for your Hobie 16, 17 or 18. Their one piece construction and plastic bushed pin holes guarantee pin hole alignment, reducing rudder pin wear, slop and drag.

50102011 H16 ea

60102011 H17-18 ea*

(* H18 Cast Gudgeon includes a rudder pin, cotter keys and washers.)



LOCKING GUDGEON SCREWS No more re-tightening gudgeon screws. As of 1996, Hobie Cat changed gudgeon screws on all new boats to "long lock" screws. Similar to a Nylock Nut, this screw has a nylon insert almost the full length of the threads. The nylon insert screws into the aluminum transom plate and provides the same resistance to movement that the nylock nut does.

8030401 Screw, 12-24 Long Lock
Pack of 16



STAINLESS STEEL RUDDER PINS Made from 3/8" stainless steel rod, these rudder pins are extremely durable. Sold Each.

20880011 H14,16 ea

60880011 H18 ea

FIBERGLASS RUDDER PINS Durable, wear resistant fiberglass rudder pins won't corrode in salt water. 3/8" diameter provides tight fit and eliminates some of the slop due to worn out gudgeons. Sold in pairs.

5051 H14/16 Pair

5052 H17/18 Pair

STANDARD RUDDER PINS Sold Each.

10881000 H14 Nylon

20880001 H14/16 Alum

60880001 H17/18 Alum



RUDDER CASTING BUSHING Are you plagued by sloppy rudders? Do your nyliners keep slipping out? Open up the holes in your rudder castings to 7/16" and install these insulating, self lubricating nylon bushings.

8062001 Set of Four

STANDARD HIKING STICKS

See the part diagrams on pages 43-61 for the standard hiking stick to fit your model Hobie.

ALUMINUM HIKING STICKS Fine quality budget priced hiking stick. Extend to the most comfortable length. Yoke is included. Available in silver only. Not class legal for racing.

- 3201** 54"-96"
- 3202** 43"-71"
- 3203** 42"-96"
- 3205** Yoke Connection

ARRIBA "HOT STICK" HIKING STICKS Impact resistant fiberglass telescoping hiking stick. Cam shaped internal shaft locks outer shaft with simple 20° twist of handle. Uni-directional lock for smooth sliding action. No moving cam parts. Full length grip surface allows twist lock/unlock along entire length. Elastically coupled hinge is tough. Yoke for attachment to tiller cross bar is included.

- FX3** 52"-96" (H16)
- FX4** 57"-105"
- FX6** 63"-120" (H17,18SX &21)
- 3208** Replacement rubber grip



HIKING STICK SOFT GRIP This soft grip for your tiller extension eliminates "slippery stick". Twelve inches long, made of UV tolerant closed cell foam. Glues on.

- 3207** FX/Hot Sticks
- 3206** Standard Tillers



HIKING STICK BALL GRIP Many sailors prefer the "feel" of a round grip. Install a 2 inch Ball Grip on your Arriba FX or Hot Stick hiking sticks for that solid contact between yourself and the rudders.

FXGRIP Kit



THIRD HAND This is the closest thing you can get to "self-steering" on a Hobie Cat. This handy little device grips the hiking stick, holding the tiller at whatever position you please. Great for light air sailing or when paddling in if the wind dies. It also keeps the rudders from flopping around when on the beach. Attaches at each end of the traveler track. For the Hobie 14 & 16 only.

- 204** Pair



BALL LOCK PINS Remove hiking stick from the cross bar for trailering or storage without the hassle of unwinding and dropping "ring-dings".

- 20303** Aluminum.
- 20304** Hot Sticks



TILLER CONNECTOR & ADJUSTMENT (HOBIE MIRACLE 20 STYLE) We've taken the tiller connection system for the Hobie 20 and adapted it to all of the Hobies. Now you can have the no slop, easy adjustment, 10 second assembly/disassembly convenience of the latest in tiller crossbar connection systems. There is no better tiller connection and adjustment available at any price!

- 1953** Pair

TILLER CONNECTION KIT Complete tiller linkage replacement kit. The contoured spacers fit snugly against the tiller end caps and crossbar alignment end cap to eliminate linkage sloppiness without spending a fortune. Includes all required parts.

- 3052** Pair



RUDDER CAM KIT Replace the rudder cam and flared pin with this kit that includes a pair of cams and a pair of binding post screws.

- 5202** H14/16
- 5204** Wave, 17 and up* *(H18 '86 & up)



RUDDER STIFFENING KIT Beware of imitations! Features special high density polyurethane washers that will last and last. Highest quality components. These washers and stainless steel Nyloc nuts work great to give your rudders that tight fit. Eliminate wobble between rudder blade and upper casting. Don't settle for less—Get the ORIGINAL.

- 136** Kit

RUDDER CAM SISTER SCREWS Replace your old flared pins with these reusable pins. No more riveting and drilling. These reusable binding post screws let you change rudder cams with the turn of a screwdriver. Sold by the pair.

- 5201** H14/16
- 5203** Wave, 17 and up* *(H18 '86 & up)

- 5201** H14/16
- 5203** Wave, 17 and up* *(H18 '86 & up)

TECH TIP!

To have that right feel... you have to have a rudder system from hand grip to the lower tip of the rudder, that is without slop and can be adjusted to your comfort and convenience. Whatever your steering system problems, you'll find the proper fix in this section.



KICK BACK KIT Returns rudders to locking position quickly and effortlessly. Really great when sailing in weed filled waters. Installs on the existing rudder bolts. Fits all Hobie 14's/16's. Class legal.

- 1544** Kit



JIB TRAVELER CARS

for the integrated track crossbar on the Hobie 16! Standard equipment as of late 2005. This jib traveler is constructed of Zytel. Zytel is made of glass reinforced nylon which results in a very strong material. This resists fatigue and impact failure. Brass traveler bearings for easier movement under load. Includes holes for anchoring traveler and traveler return lines.

25232201 Port

25232211 Starboard

See H16 parts diagrams for replacement parts.



ROLLER FAIRLEAD KIT Simple to install kit converts cleat arrangements that use "bullseye" fairleads to roller fairleads, reducing friction and line chafing. With all hardware. A screwdriver is the only tool needed. Accepts up to 1/2" line.

50012 Kit



FAIRLEADS

Keep your crew happy! These line leads are non-invasive.

H328 For 150, 365

H329 For H423

(Cammatics not included.)

HOBIE CLUB WAVE MAIN TRAVELER KIT

Upgrade any Wave Club model to have a main traveler system. The addition of a main sail traveler will offer better sail control in higher winds and down wind sailing angles. Helps to limit heeling in higher winds while optimizing speed potential. Also reduces loads on the bows, therefore reducing the amount of dive or pitch pole potential. Go faster with better control! Kit includes deep profile traveler track, rivets, #111 brass wheel traveler car, swivel cleat, mount and instructions.

39250000 Club Wave Main Traveler kit

TRETEC JIB TRAVELER CAR

Provides the super low profile needed with raked back masts. Slides in track easily. Can be used with bullet block shackled to sheet rope lead eye to reduce friction to a minimum. Requires traveler car trim system and sheet rope cam or lance cleat.

1552 H16 Pair for Original SS Track

1553 Jib Cars for Integrated Track



LO-PROFILE JIB BLOCK For the Hobie 16 original SS Tracks. It is a basic swivel cam cleat with roller fairlead and Harken aluminum jaw cammatic, mounted on a stainless steel slide. It self aligns with the angle from which the sheet rope is being held for ease of cleating no matter where the crew is positioned. It's one piece, easy to install, light weight, low profile, interchangeable with left or right side and self aimed at the windward side of the boat.

1075 W/Cammatic

1076 W/O Cammatic

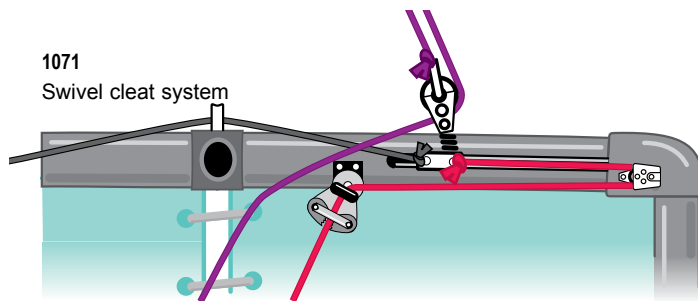

1071
Swivel cleat system

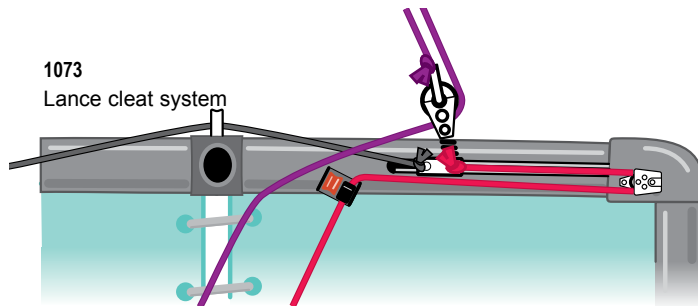

1073
Lance cleat system

JIB TRAVELER TRIM KITS These traveler adjustment systems can be used while out on the trapeze. They work with all of the jib cars available. They can both be set up to self return the cars inboard or outboard. Color coded trim lines and all hardware are included. The 1071 kit with swivel cam cleats allow cleating and uncleating from any position on the boat. Lance cleats in the 1073 kit limit the location from which trim lines can be cleated.

1071 Kit w/Swivel Cam Cleats

1073 Kit w/Lance Cleats



LANCE CLEATS The lance cleat utilizes a single rugged aluminum alloy cam mounted vertically in a black molded frame. Just slide the rope sideways and it runs freely in the fairlead, which has a colored roller incorporated in the top for easier sheeting and identification. Ideal for use in confined spaces. For use with 1/4" line. The base size is 1/16" x 15/16". Height is 7/8".

R359S Stbd

R359P Port



SWIVEL CAM CLEATS Swivel cam cleats feature the Harken Cammatic Cleat. The Cammatic is matched with either the standard bullseye fairlead or the Roller Fairlead. The bullseye fairlead is available with either the plastic jaw Cammatic H365 or the aluminum H150. The roller fairlead is matched with the aluminum jaw H150 Cammatic only.

50007 Eye w/ H365

50009 Eye w/ H150

50013 Rollers w/H150

B323 Dead eye only



ACCESSORY MOUNTING PLATE

Universal mounting plate for swivel cam cleats, compasses, drink holders, etc. High strength black Delrin® construction that is ultraviolet tolerant.

1161 w/o Hardware

1162 w/Hardware



SWIVEL CAM CLEAT

50017 Each



HARKEN WEDGES Fairleads and eyestraps designed specifically for each Cammatic model, the wedges put the Cammatic on a 15 degree angle for ease of cleating or releasing. The fairleads are molded into a replacement base for each Cam-matic. The eyestraps are designed to be held in place over the cams by the mounting screws.

WEDGE KITS

H145 (H150 & H365)

H297 (H423)

WIRE FAIRLEADS

H298 (H150 & H365)

H284 (H423)

EYESTRAPS

H137 (H150 & H365)

H201 Low (H150 & H365)

H281 (H423)



ADAPTER PLATE Universal mounting plate that allows you to add the Cammatic Cleat to nearly any cleating system now in use. Includes mounting hardware.

50010 Kit



Traveler Tamer I



Traveler Tamer II

TRAVELER TAMER™ Travel Tamer™ I replaces the plastic sheaves on the Tracker traveler car with larger, ball bearing rollers to reduce friction. Traveler Tamer II replaces the "bullseye" or roller "fairlead" on the swivel cam cleat with a new swivel cam cleat base with roller bearings installed. Use your old Harken Cammatic or order separately.

50014 Tamer I

50015 Tamer II



HARKEN CAMMATIC

CLEAT Rounded jaws assure quick cleating/release action and smoother teeth mean longer life for your sheets. Hardkote teflon impregnated die-cast aluminum cams and base with three rows of ball bearings provide a long lasting investment. Use with #50010 Adapter Plate for most change overs.

H150 Cleat Alum Jaw

1/8" to 1/2" line

H365 Carbon Matrix Jaw

1/8" to 5/16" line

H423 Micro Cleat, Carbo Jaw

1/8" to 1/4" line

HARKEN 2 1/4" BLOCK LOW PROFILE 6:1 Successful racers have gone to super low profile systems on Hobie 16's (6:1) and 18's (7:1). This allows the sailors to achieve more mast rake for better pointing ability and reduced pitch pole tendency. They are using the Harken 2 1/4" ratchet block and boom blocks with 3/8" line. The lower block is customized to allow the post to enter the traveler car hinge plate on the Hobie 16. To convert to 7:1, H18 sailors add a mini-block to the eye that's normally used to tie off to and then tie the line off on an empty boom bail. New Hobie 16s come with H194 Lower ratchet and H2640 Carbo upper.

H2640* Upr 40mm Carbo

H153* Upr 2.25" Block

H194* Lwr 2.25" Block

* use 3/8" sheet rope for smooth flow of line through blocks.

H125 Mini Block (to 7:1)

Note: add 8' to sheet rope length when converting to 7:1 system.

TECH TIP!

BOAT CHECK LIST There are a number of items to check on your boat. Do this on a regular basis and before sailing for the first time each season.

Here are a few of the basics...

STANDING RIGGING (wires) - Check for broken strands. Inspect and slightly bend at all fittings to find broken strands (replace if needed). Check all clevis pins and keepers.

HARDWARE - Check for bent or damaged shackles and other components.

LINES - Check for wear.

HULLS - Check for leaks and possible structural problems. Delamination of the hull structure could lead to major failure.

MAST - Check mast and all aluminum spars for corrosion and other damage. Corrosion can cause structural failure.

RUDDERS - Check the cam lock-down system. This should be free of dirt and sand. Grease regularly to allow free rotation motion.

DRAIN PLUGS! - Need we say more.



H2640



H194

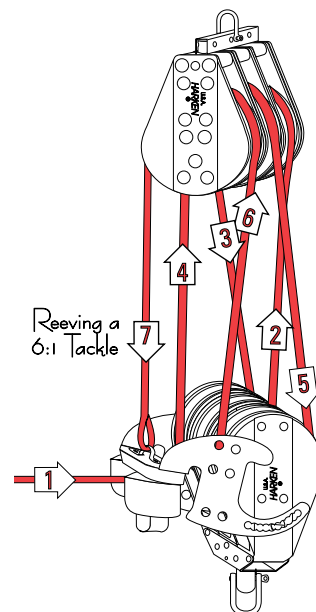



H224



H226



H228



H225



H227



H233

HARKEN MICRO BLOCKS Small blocks with high load capabilities, but light weight. Accepts up to 1/4" line, 1200 pound load, 7/8" diameter sheave.

H224 Single

H225 Single w/Becket

H226 Double

H227 Double w/Becket

H228 Triple

H231* Triple w/Becket & Cam

H233 Cheek

H244 Fiddle Micro

H232 Traveler

(*not shown)



H232

H244



H082



H083



H166



H084



H092



H167



H353



H125



H126

HARKEN BIG BULLET BLOCKS AND DINGHY BLOCKS Big blocks accept up to 3/8" line, 2000 pound load, 1 1/2" sheave.

H125 Single

H126 Single w/Becket

H023 Dinghy Single w/Swivel



H023

HARKEN BULLET BLOCKS Medium size blocks that work well for control line or jib sheeting lines. Accepts up to 5/16" line, 2000 pound load, 1 1/8" diameter sheave.

H082 Single

H083 Single /Becket

H084 Double

H092 Cheek

H166 Single w/Swivel

H167 Single w/Swivel & Becket

H353 Traveler

HARKEN MICRO, BULLET & BIG BULLET BLOCKS Harken makes more blocks than you might believe there would be a use for. We have selected several that, we believe, will fill most catamaran sailor's needs. We carry all Harken products. If you don't see what you need, order it and we will get it.



HARKEN 16MM AIR BLOCKS Harken's newest small blocks for control lines. Accepts up to 7/32" line, 900 pound load, 5/8" sheave diameter. Ultra light weight.

H404 Single

H405 Single w/Becket

H406 Double

H407 Double w/Bckt



RF56101

AUTO RATCHET BLOCK BY RONSTAN

Perfect for spinnaker sheet turning blocks. This Ronstan block is free wheeling at low wind velocity. As the wind velocity increases the pressure on the sheave automatically engages the ratchet. The sheet rope is never trapped in the sheave and can slide out the same as any other ratchet block without first pulling in and then releasing. 55mm sheave.

RF56101 Auto Ratchet

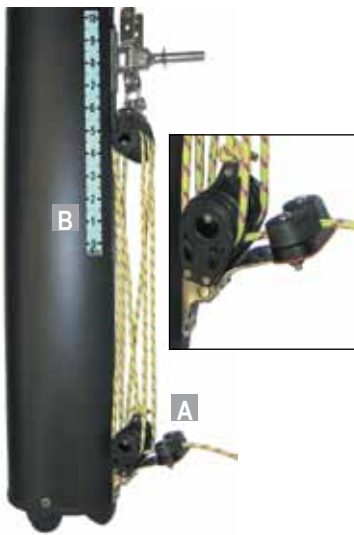

A NEW 6:1 DOWNHAUL KIT downhaul system for Hobie 14 and 16. **Now Class Legal.** Kit comes complete with Harken carbo triple block and triple with cleat. Includes class approved attachment for base of mast, all hardware and line. Use with the gooseneck slide kit # 1511.
2089 6:1 Kit

B DOWNHAUL SCALE Can you ever remember where the downhaul was set that day you "smoked" everyone. This handy stick on scale takes the guess work out of setting the downhaul.
2082 Each

POWER PAK 6:1 Downhaul , 2:1 Outhaul systems for Hobie 14 and 16. Rotation control for H14. Jib halyard upgrade for H16.
2090 H14 Power Pak
2091 H16 Power Pak

H228



H231



HARKEN TRIPLE W/BECKET & CAMMATIC Perfect for H16 or H17 downhaul.
H231 Each
H228 Each



GOOSENECK BEARING Eliminates drag and prevents gouging the gooseneck slide on Hobie 14, Hobie One-14 (Holder) Monohull and Hobie 16 luff track. Delivers a fantastic improvement in downhaul adjustability!
1511 Kit



POWER DOWNHAUL SYSTEM COMPONENTS Major components from the Power Downhaul System are available and listed below:

H291S Harken mini swivel control cleat assy.w/cam

H226S Harken double micro block with twist shackle for gsneck ring (H16) or lower block (H18)

H225S Harken single micro block w/ becket and shackle for lower block (H16)



EYE STRAP FOR BOOM VANG Heavy duty eye strap for connecting boom vang at the mast base rather than at the trampoline slot in the cross bar.

2072 With Fasteners



DOWNHAUL / HALYARD SHEAVE Ease raising the sail and/or adjusting the downhaul with Harken ball bearing sheaves. They really make the job a whole lot easier. A direct replacement for the sheaves that came with the early Hobie 17's.
H160 Each

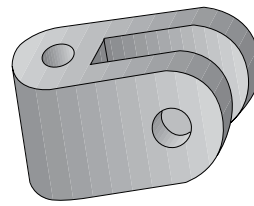

TRETEC SUPER GOOSE Adds convenience and security of attachment at the boom to mast connection. Replace the vertex that connects the boom pin to the gooseneck yoke assembly on the mast. Custom made for the Hobie 18, machined from a block of 6061-T6 aluminum and hard coat anodized. Will not bend and open up no matter how strong the wind. Go a step further and permanently secure the clevis pin that connects that Super Goose to the boom pin with a cotter key. Replace the nut and bolt connecting the vertex to the mast yoke with a 20304 ball lock pin.

1510 Each



BOOM VANG Features fiddle blocks with cam cleat on upper block for easy release and tensioning. Open hook allows quick connect and disconnect from trampoline slot in front crossbar or mast base.

2073 Standard 3:1



HOBIE "AUSSIE" HALYARD RING The Aussie Halyard Ring makes engaging and disengaging the halyard ring from the halyard hook a real snap. This device keeps everything at the right angle. Welded one piece design. Hobie 18 ring has a twist shackle with a captive clevis pin so there are no parts to lose.

3064 Each



HALYARD GRIP Keeps those halyards close in to the mast and out of the way so that the jib doesn't hang up on them. Molded from strong Delrin and contoured to the curve of the mast. One on each side of the H16 mast does the trick.

114 Each w/hardware

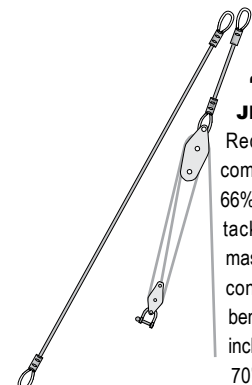

HOBIE 16 "AUSSIE" JIB HALYARD

Reduces mast compression by 66%. Allows easier tacking, better mast rotation and consistent mast bend! Complete kit includes hardware, 70' (Dyneema®

or equivalent) halyard line, zippered pouch, and instructions. Racing class legal.
80660000 Kit

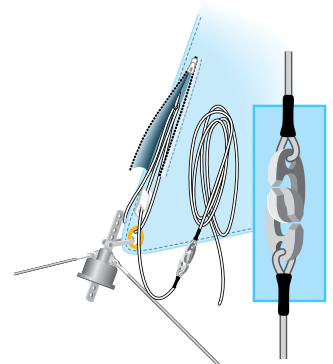

L'IL SISTER CLIPS The answer to "What to do with all the jib halyard?" L'il Sister Clip speeds the untie and retie of your H18 jib halyard. Includes both segments of jib halyard.

CM7732 Set



BOW SHACKLE - THREADED PIN

Part #	Pin Dia.	Width	Length	Max Ld#
SP150061	1/4"	9/16"	15/16"	4400
SP150081	5/16"	11/16"	1 1/4"	6600



"D" SHACKLES - THREADED PIN

Part #	Pin Dia.	Width	Length	Max Ld#
SP150041	5/32"	3/8"	5/8"	1100
SP150051	3/16"	1/2"	11/16"	2640
SP150052	3/16"	5/8"	15/16"	2640
SP150053	3/16"	5/8"	1 7/16"	2640



SAFETY SHACKLE WITH 1/2 TURN CAPTIVE PIN

Part #	Pin Dia.	Width	Length	Max Ld#
SP180004	5/32"	7/16"	3/4"	1320
SP185205	3/16"	1/2"	1"	2640
SP180005	3/16"	5/8"	1 7/16"	2640
SP180006	1/4"	7/8"	1 5/8"	4400



TWIST SHACKLE WITH 1/2 TURN PIN

Part #	Pin Dia.	Width	Length	Max Ld#
SP170005	3/16"	1/2"	7/8"	2640
SP170006	1/4"	9/16"	1 3/8"	4400



SWIVEL SHACKLE Complete with clevis & split rings. Align blocks, Fittings, etc. B-094 is extra heavy duty.

Part #	Pin Dia.	Width	Length	Max Ld#
B094	1/4"	1/2"	11/2"	1000



FAST SHACKLE The Fast Shackle was created for the jib clew blocks on the Hobie 16 & 18. It's a halyard shackle and an Avibank ball lock pin permanently wired to the shackle so it won't drop in the drink when the blocks are released from the jib clew.

3062 Each



SNAP SHACKLE Makes it easy to remove expensive mainsheet systems from your boat when it's parked on the beach or for ease of take down and set up for trailering.

20803 Each

Hobie

To order from your nearest Hobie Cat dealer
 U.S.A. hobiecat.com 1-800-HOBIE-49
 Australasia hobiecat.com.au 1-800-4-Hobie



SPARE PARTS - ALL PACKAGED IN 12" ZIPPERED POUCHES

	H14	Wave/Get	H16	H17	H18	H20
Shackle tool	•	•	•	•	•	•
2 Drain plugs w/gskts	•	•	•	•	•	•
Pair of rudder pins	•	•	•	•	•	•
Clevis pin set	•	•	•	•	•	•
3/16" Bow shackle	•	•	•	•	•	•
1/4" Bow shackle	•	•	•	•	•	•
Twisted shackle					•	
Mast bearing(s)	•		•		•	
3 Batten tie lines	•	•	•	•	•	•
1 Ft. sail repair tape	•	•	•	•	•	•
Part Number: 303-	05	08	06	14	07	20



CONVENIENCE PARTS

	H16	H17	H18
QR Pin for forestay adjuster	•		
Fast shackle or jib tack shackle	•		
Quick release pin for main traveler car	•	•	
Quick release pin & shackle for main traveler car			•
Quick release pin for hiking stick	•	•	•
Shockcord hooks(4) for trapeze shock cord	•	•	•
Quick release pin for outhaul		•	•
Quick release pin for boom to mast		•	•
Safety pins for rudder pins	•	•	•
Part number 303-		11	15
			12



BALL LOCK PINS Take the hassle out of rigging and de-rigging your boat. Replace 3/16" and 1/4" clevis pins that use ring dings with easy-to-use push button pins. These "quick pins" are usable in a variety of places on your boat and will not work free by themselves. Use them anywhere a clevis pin can be used! Caution is advised when using these for standing rigging as some inspection or maintenance of the ball lock system may be required to avoid a de-masting.

BALL LOCK PINS

	Fstay Shrds	Hiking stick	Outhaul	Goose-neck	Traveler car	Jib tack
20301 3/16"x3/4" Cup Head					14,16,17	
20302 1/4"x3/4" Cup Head	•		18,21			
20303 1/4"x1 1/4" Ring Hd		Std				
20304 1/4"x1" Ring Head				•		
20305 1/4"x1" Cup Head				•		
20306 #20305 w/Tack shackle & lanyard			20		18,20,21	•
20307 1/4"x1 1/2" Cup Head		Extendables				
20311 3/16"x3/4" Ring Head	Old H14			•	14,16,17	
20312 1/4"x3/4" Ring Head	•					
20313 3/16"x1/2" Ring Head					14,16,17	
20314 1/4"x1/2" Ring Head	•					
20310 8" X 1/16" Wire Keeper with NicoPress Sleeves						



CLEVIS PIN ASSORTMENTS For Hobie Wave, Getaway, 16 and late model 14. Kit contains appropriate 1/4" clevis pins, 3/16" clevis pin for traveler car, 1/4" clevis pin for mast step link. Split rings are included.
30303 H16 / 14 Set
30302 Wave / Getaway Set



CLEVIS PIN ASSORTMENT For Hobie 17/18. Kit contains 4 each 1/4" clevis pins and 1 each 1/4" headless clevis pin for mast step. Split rings are included.
30304 H18 Set
30317 H17 Set



KEEPER PINS Great little helpers for quick rudder removal. Forget the aggravation of straightening those cotter pins! A definite plus for trailering. Stainless Steel.
20501 5/16" Diameter
20502 3/8" Diameter
20503 Safety Pin



SUPER LOW STRETCH LINE Pre-stretched polyester line with superior fatigue and abrasion resistance. Our line (3/16"-3/8") tested as the lowest stretch (.5%) of any all polyester line available. Sold per foot.

- RH112WHT** 1/12" White
- RH018WHT** 1/8" White
- RH316WHT** 3/16" White
- RH014WHT** 1/4" White
- RH516WHT** 5/16" White
- RH038WHT** 3/8" White



SUPER STRETCH SHOCKCORD This midnight-black shockcord has double the stretch of ordinary cord. If you've been getting your shockcord from the hardware store, you're in for a treat. The durable black cover is woven around an extra-flexible rubber core.

- RS018BLK** 1/8"
- RS316BLK** 3/16"
- RS014BLK** 1/4"
- RS516BLK** 5/16"
- RS038BLK** 3/8"
- RS716BLK** 7/16"

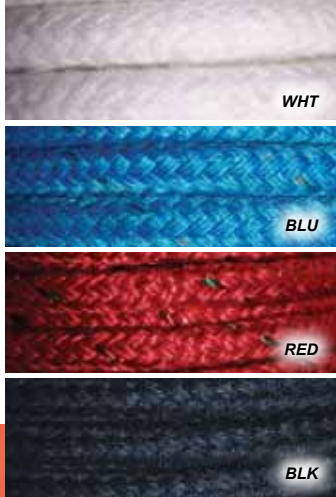

SPUN DACRON Soft matt finish rope for main & jib sheets of racing dinghies and day sailors. Runs well thru blocks and fairleads, has good abrasion resistance, is spliceable and easy to hold with wet hands. Available in white, black, red, blue. This rope is not designed for winching. Sold per foot. Specify color choice. (White, Blue, Red or Black xxx = color)

- RM014WHT** 1/4" White
- RM014XXX** 1/4" Color
- RM516WHT** 5/16" White
- RM516XXX** 5/16" Color
- RM038WHT** 3/8" White
- RM038XXX** 3/8" Color
- RM716WHT** 7/16" White
- RM716XXX** 7/16" Color



RONSTAN DINGHY LIGHT The ultimate dinghy sheet and multi-purpose rope. Dinghy Light is a rope made of an XLF core/sheathing weave. It is used wherever low water absorption is crucial, making it particularly recommendable for use as a light-weight spinnaker sheet.

The sheathing made of XLF is a 40-plait weave offering excellent abrasion resistance. For the core, an 8-plait weave is used, making the rope round and compact.

Sold per foot. Colors may vary.

- 8004651** 1/4" (H16 Jib)
- 8004631** 5/16" (H16 Main)



ONE WRAP VELCRO® Cut this double faced Velcro® product to length and wrap it around your mast, halyard line or whatever you need to secure. One side is hook and the other a loop, so a single piece is all you need.

7904 One Wrap, per foot



SHOCKCORD SNAP HOOKS New, easy to install shockcord snap hook. No snag design. Slide collar over shockcord, place snap hook on shockcord end and slide collar in place. No tools required. Reusable!

- 2101** Hook-1/4"
- 2102** Hook-5/16"



AMSTEEL High modulus Polyethylene (aka SK75 Dyneema) 12 strand single braid and is urethane coated for maximum performance. Its tolerance to abrasion is excellent and it is resistant to degradation from ultra violet. This line will also float and has zero water uptake. Color may vary.

8004951 H16 Aussie Halyard



ROBLINE Constructed as a hollow-fiber plait, made of impregnated polyamide and Dyneema® SK 75. These materials make the rope extremely abrasion-resistant and low stretch. The sheet is easy to grip, even when wet, and is easy to splice. Tigers: 5mm for spinnaker halyards / 8mm for spinnaker sheets / 10mm for main sheets

- RF05BW** Robline 5mm Blue/White
- RF08BLU** Robline 8mm Blue/White
- RF10GRY** Robline 10mm Gray

STILL THE BEST RIDE



Since 1950 We've Made the Best Rides

All Hobie kayaks have sleek, seamless, lightweight roto-molded polyethylene hulls. The result? Kayaks that effortlessly, gracefully, glide. And all our kayaks have a closed-deck design with self-draining scuppers and seats to keep you dry. You can pedal, paddle or sail them.

In our Hobie Mirage models, you can take your kayak further faster with our unique MirageDrive system. It works much like a penguin's fins to propel the Mirage with surprising speed and ease. All of which lets you go into kayaking, feet first.

POWERED BY



1-800-Hobie-49 • hobie kayaks.com

HOBIE-TRAILEX ALUMINUM TRAILERS

TRAILERS Anodized aluminum trailers by Trailex, custom designed for Hobie. The best trailers for light weight and long, low maintenance, life.

Getaway / H16 / Tiger trailer (Pictured here) is shown with optional double rollers. Includes forward mast stand. Rollers or cradle attachment hardware is optional. Double roller kit is recommended for Getaway, H16 and similar cats. Cradle attachment kit is recommended for Tiger or other cats to 18' using cradles. Order roller kit, cradle attachment kit and cradles separately. An optional rear mast stand is also shown.

Wave / Bravo trailer has single rollers and carpeted bunk guide pads for the hulls to rest on, does not include a forward mast stand (Optional, order separately).

37653000 HOBIE GETAWAY / H16 / TIGER TRAILER
(Shown with options: double rollers and rear mast stand)

38651200
Rear Mast Stand
Optional

TECH TIP!

1 7/8" Coupler

TRAILEX ALUMINUM TRAILERS

Why Aluminum? It is long lasting (Does not rust or corrode), It looks good for a lifetime. It holds its value. In today's busy World, it is one thing that needs no maintenance.

Bolted aluminum to create the lightest trailers. The bolting eliminates materials and weight, makes a modular unit and remains strong.

1/2 the weight because of high tech aluminum extrusions.

Lightweight means better gas mileage! Can also be towed with smaller vehicles. Less wear and tear on your vehicle.

- 38650200 HOBIE-TRAILEX TRAILER BRAVO
- 38651000 HOBIE-TRAILEX TRAILER WAVE
- 38653000 HOBIE-TRAILEX TRAILER GETAWAY, 16, TIGER
- 38653100 HOBIE-TRAILEX DOUBLE ROLLER KIT
- 38653200 HOBIE-TRAILEX CRADLE ATTACHMENT KIT
- 38651100 FORWARD MAST STAND
- 38651200 REAR MAST STAND

Trailer prices DO NOT include freight to dealer or assembly costs.



HULL CRADLES For rounded fiberglass hulls, cradles distribute the trailering loads over 800 sq. in. of the hull to assure there are no excess stresses while trailering. Custom molded H20 version fits all Hobies but the Hobie 21SE/21SC/Fox/Tiger/FX One. H20 Rear cradles include tilt bracket for easy off and on loading of boat on trailer (Includes installation hardware).

- 48000001 H20 Style Set of 4
- 48030001 Front - Pair
- 48040001 Rear - Pair (with tilt)
- 1624 All others - pair (no hardware)

To order from your nearest Hobie Cat dealer
U.S.A. hobiecat.com 1-800-HOBIE-49
Australasia hobiecat.com.au 1-800-4-Hobie

SAIL STORAGE BOX "TOY BOX" The original Toy Box! Made by roto-molding as one seamless piece with molded-in graphics. Big enough to hold two sets of Hobie sails, booms, daggerboards, rudders and have room left for odds and ends. The bottom is ribbed to allow wet things to drain. There is full access from front and back, even with the boat on the trailer. Mounting hardware is not included. This storage box doesn't care if you sit on it, fill it full of rocks and drop it from 10' or however else you brutalize it. It's tough.

Length 10' 4", Width (rear) 21", Depth (rear) 13", Width (front) 19 1/2", Depth (front) 10", Weight 55 lb. *Prices DO NOT include freight to dealer.*



1825WHT One piece sail box. Additional freight charges may apply.



TIE DOWN STRAPS This outstanding four strap system features patented over center cam action locking buckles coupled with super-strong 2000 lb. test web straps and hooks. The tie downs secure your boat to any trailer in seconds. Full 1 year warranty on all parts. Custom Tie Downs come complete with all mounting hardware and instructions.

1791 Wave Tie Downs

1793 H14/16

1794 H17/18



“ACROSS THE HULLS” TIE DOWNS One piece tie downs with hooks (and retainers) at each end and paddle handle buckle for easy adjustment. Each tie down is 2" wide by 13' long.

1795 Each



HOBIE MAST CRADLE Fiber glass mast cradle for the Hobie 14, 16, 17 20 & 21SC. Molded to the shape of the rear cross bar and carpeted to protect the mast and cross bar. Includes a simple single shock cord tie down that secures the cradle to the cross bar and the mast to the cradle.

3175 Mast Cradle for Hobie Wave, 14, 16, 17, 20 & 21SC



SHOCKCORD BALL TIES Lashing the wires to your mast for trailering is quick and easy with this handy tie-down. Use a couple to keep your jib furled on the beach and your sails rolled in the bag. Dozens of other uses.

370 Each



WAVE MAST TIE DOWN KIT Includes fiberglass support and shockcords necessary to secure mast to the boat while trailering. Quick and easy to use. (Use of forward holder on Wave SE tramp requires modification, addition of one grommet in forward edge of trampoline).

38650031 AFT

38650041 Mast in 2 sections on tramp (Set of two shown)

TECH TIP!

Mast stepping Usually a two person job. For those days you need help, want to single hand or be able to rig the boat alone for any reason, a mast stepping aid is what you need. The primary function of a mast stepping aid is to raise the mast while restraining side movement induced by a cross wind. Often it is more difficult to handle the side motion than it is to raise the mast. It's the side motion that breaks or bends the hinges and/or mast base castings.

HOBIE MAST STEPPER This system has a gin pole that rests on a foot attached to the trailer. The mast is stabilized by tying a trap wire on each side to the front cross bar. Attach the trailer's winch (not provided) to the forestay and hoist away. Utilizes bridles to stabilize the gin pole while hoisting the mast.

3152 MAST STEPPER

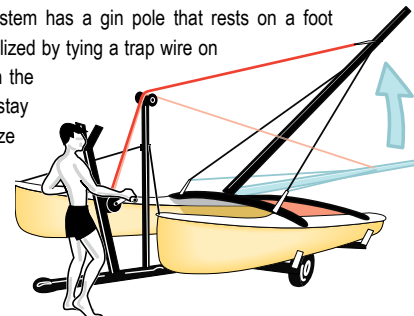

MAST STEPPER II Easy to install because it eliminates the trailer mounted gin pole. However, the Mast Stepper II system does require that the trailer's forward mast support be 30" taller than the mast step. The mast is stabilized by tying a trap wire on each side to the front cross bar. The kit includes all necessary lines, shackles, blocks and instructions. Purchase winch separately.

3155 MAST STEPPER II

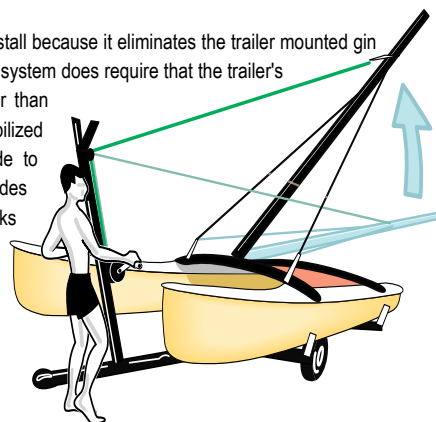

3153 Winch (900 lb. capacity) No line included*.

* Listed winch has a capacity of 40' of 3/16" cable or line - 30' of 3/32"

HOBIE MAST STEPPER III Specifically designed for the Hobie Getaway due to the rotated mast position when stepping. Can also be modified to work on Hobie 17, Tiger and 20. Step your mast with ease and safety. Specially designed bracket attaches to mast at base. A pole plugs into the bracket to create a gin pole arrangement that allows you to singlehandedly raise and lower your mast. It uses the trailer's winch (not provided) for power. Lines snap in place to eliminate side-to-side sway. Attaches quickly without tools. No modifications to boat. Can adjust to fit other rotated-position stepping masts.

3156 HOBIE MAST STEPPER III

3153 Winch (900 lb. capacity) No line included*.

EZ STEP™ As item above shows, a simple gin pole arrangement allows you to singlehandedly raise and lower your Hobie mast. It uses the trailer's winch (not provided) for power. Lines snap in place to eliminate side-to-side sway. Attaches quickly without tools. Adjusts to fit any catamaran.

3151 EZ STEP

3153 Winch (900 lb. capacity) No line included*.



CAT TRAX

CAT TRAX Cat Trax has become the standard catamaran dolly for moving catamarans over sand, mud, rocks, or any surface. Lightweight and rustproof. Fast and simple tiedown attachment. Your cat rolls effortlessly on smooth running low friction Delrin® bearings. Jumbo 11" x 21" balloon tires disperse weight, don't dig in on soft surfaces. Tough padded end-caps hold the boat in line. No rust, no lubrication, no hassles. Stores easily on the tongue of your trailer. Cradles not included except as noted.

1621 Cats to 8' Beam

1622 Hobie 20/21SC (8'6" beam)

(H20 add cradles #48010001, H21SC add cradles #1624)



TRAX

BLUE TRAX The "hard wheeled" version of the all time favorite catamaran beach dolly. Wheels that never need air so they won't go flat. Features the same needle bearings as the Cat Trax. Light weight.

1626 Blue Trax

1625 Blue Wave Trax



HULL CRADLES-BEACH DOLLY

Cradles distribute the boat load over 400 sq. in. of the hull to assure there are no excess stresses while carrying. 48010001 is custom molded for the H20 hulls, Fits P18.2, P19, Nacra 5.2 & 5.8 also. Fits all popular beach dollies.

48010001 H20 pair

1624 All others pair



TRAX "T" HANDLE

TRAX ACCESSORIES

1623 T Handle - Attach to Axle (shown above)

1620 End Cap-Each

1637 Cat Trax Axle (8' or 8 1/2')

1635 Replacement Cat Trax Wheel Assy

1636 Replacement Blue Trax Wheel Assy

NOTE: ADDITIONAL FREIGHT CHARGE ITEMS
Carts and Trax items shown on this page incur additional freight charges.



H16 Dolly

DOLLY The dolly includes a handle so you can easily slide the cart under the boat and push or pull along holding the handle. Box tube aluminum frame and air inflated tires. Frame has dual contact points / crossbars, so hull is balanced on the cart.

90870000 Bravo Dolly

70000111 H16 Dolly



UNIVERSAL COVERS This is designed to fit a variety of boat lengths, cut into general catamaran shape. It's made of tough woven polyethylene that is coated on both sides, one side silver, one side black. We've chosen this polyethylene because of its excellent resistance to ultra-violet degradation. It is a woven rather than sheet fabric to provide great tear strength. These covers will tolerate sun, wind, rain, high and low temperatures, and not fall apart. This fabric was specially designed for outdoor application. Install with silver side out.

Each cover is cut to be used for a boat length range. Tapes are sewn in place to allow you to secure the cover around the hulls and crossbars. Custom features such as cut outs or slits for wires or wings can be created with scissors. The edges will not catch, fray, or pull. We include 5 feet of adhesive backed velcro with each kit to be used to prevent slits from flapping in the breeze. *These covers are not designed to be used while trailering.*

314-13ALL HOBIE WAVE

314-14TO17 14' to 16'8" range

314-16-GTWY Getaway

314-17TO18 17' to 18' range

314-19TO20 H20

F99267585 TIGER CUSTOM COVER

TECH TIP!

BOAT COVERS Boat covers are designed to protect your boat from UV degradation and dirt. Universal storage covers are one piece and designed for easy installation. They fulfill their purpose mast up (with minor modification) or mast down, on the beach or on the trailer. The fabric is woven polyethylene that is film coated on both sides to cover the woven fabric. It has fantastic tear resistance and is specifically designed for outside use. UV tolerance is one of its major attributes.



DELUXE HOBIE SAIL BAG Stop fighting with your sail and boom cover. This sail and boom bag zips full length for ease and convenience and will fit any Hobie sail and boom. Full ventilation on each end with vinyl coated mesh. Added convenience with a separate compartment for line and blocks. Made with nylon Cordura®, includes double shoulder straps for maximum ease while carrying. Ends unzip to extend for extra long parts (Color may vary).

3121 DELUXE SAIL BAG



STANDARD SAIL AND BOOM BAG Pulls over boom and sail like a sock. Open end closes with a drawstring and nylon clasp. Material and color may vary.

21310000 STD 9' 5"

38990050 WAVE



SNORKEL JIB COVER Protect your roller-furled jib from attack by ultraviolet light and the weather. Easy to install and remove—the Snorkel is a must for protecting your expensive sail from eventual destruction by the elements. The Snorkel is a zip-on cover for roller-furled jibs. Made from durable fabric with a full length zipper. Snorkel covers are not intended for long term storage. Jibs must be furled tightly, have luff tension and be secure for windy conditions. Loose jibs and cover may cause chafing damage to sail.

1811 H18/H16/Sport/21S

1812 H14 Turbo/H1-14

1813 H20/H21SE/H18SX

1815 Getaway

TECH TIP!

COVERS Protect sails and hardware from sun and abrasion damage. Perhaps the greatest enemy of many modern fabrics is the sun's ultra violet radiation. It deteriorates nylon unless it's specially treated and it attacks dacron sail cloth and weakens it. Fortunately, nylon can be treated to make it UV tolerant and acrylic fabrics exhibit seemingly endless resistance to UV radiation. These sail bags and sail covers can be used to protect your dacron sails from UV radiation damage.

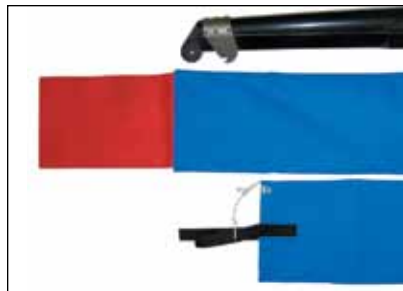

COMPTIP COVER Hobie Cat recommends that the Comptip portion of the mast be covered to protect it from ultraviolet rays. Our cover is made of UV resistance treated nylon. Ties on to the mast with line that is provided. Fits all Hobie Cats. Will not work with mast floats installed. Royal blue.

3125 Cover—H16/18/20

3127 Cover—H17/21

90991000 Cover—Bravo Mast and Sail



RUDDER COVERS For your Hobie Cat. Excellent quality. Fastex fasteners keep the rudder covers firmly in place, even when trailering. Protects your rudders from nicks and grime. Sold in Pairs. Style and color may vary.

82420000 All but 21SE



DAGGERBOARD COVER Protect those daggerboards! This two pocket, woven polyethylene lined cover is padded and has a tough, Cordura (600 denier) outer material. It has carrying handles and velcro closures. Very important for preventing dings, gouges, and scrapes while storing and trailering. This is an absolute must for the racer. Room for two daggerboards. Style and color may vary.

72410001 Tiger/Fox/FxOne

82410001 H18

82410020 H20





HOBIE

ROLLING DUFFEL BAG Huge, large enough for all of your clothes, sailing gear and then some. This heavy-duty nylon Cordura® bag has a parallel dual zipper top opening that allows plenty of space to stuff things into it. Separate compartment on one end is vented for anything that's wet and a side pocket. Rollers on one end help you get there fast without having to carry the bag. Hard bottom and rubber skids to reduce wear. Telescoping handle. 32" x 12" x 14". Colors may vary.

80000R HOBIE ROLLING DUFFEL



Telescoping handle. 32" x 12" x 14". Retracts into zippered pocket.



Separate zippered compartment on one end is vented.



HOBIE BACK PACK Carry your gear with pride! The Hobie Back Pack can fit a bunch of your sailing gear or *EVEN* books if it has to. 3 zippered compartments. Padded back support and straps. Waist strap and shoulder strap / chest buckle. Colors may vary.

80000B Back Pack



GUSSETED TRAMP

BAG Do you carry too many small things for a pouch but not enough for a storage bag? We've got the tramp bag for you. Our 6" by 12" gusseted tramp bag rises to the occasion. It has hooks on both ends to clip

to the tramp lacing and carries the Hobie logo. Also available in 8" x 12" size.

72000B 6"x12" GUSSETED TRAMP BAG

72005B 8"x15" GUSSETED TRAMP BAG



TRAMPOLINE STORAGE BAG The Trampoline Storage Bag is designed to store loose items you want to carry on your catamaran. Low profile to eliminate line hang-ups. Designed to attach between the hiking straps. One compartment (18" x 36"). Includes a clear plastic map pocket. (Built of tough Cordura fabric, not waterproof.)

3128 With Map Pocket



SEE BAG Transparent 13 oz. vinyl bags make quick work of locating things. Great for organizing gear and personal stuff. Keep your food and spare clothes dry.

Two sizes: #10 - 8" diameter by 14" high, 622 cu.in.

#30 - 11" diameter by 19" high, 2200 cu.in.

Easy to carry or tie on trampoline. Its cylindrical shape will hold odd shapes such as cameras, binoculars, lunches, etc. without distortion of bag and resultant potential leakage.

72210T SEE BAG (8" x 14")

72230T SEE BAG (11" x 19")



HATCH COVER KITS Provides access to the hull for storage and inspection. All sizes have screw-in covers. The 4" and 5" diameter covers are contoured to fit curved decks. The 6" is flat and can be used to replace the pop out covers on the Hobie 18. Kits include one pair of hatch covers, bedding material and mounting hardware.

5352W 4" Kit-White

5352B 4" Kit-Black

5351W 5" Kit-White

5351B 5" Kit-Black

5353W* 6" Kit-White

5353B* 6" Kit-Black

* Use 5403 or 5413 with 6" screw-in kit.

HATCH ONLY (COVER W/FLANGE)

- V1130** 4" White
- V1131** 4" Black
- V1093** 5" White
- V1100** 5" Black
- V1145** 6" White
- V1146** 6" Black
- 376** Silicone Sealant (RTV) 3oz

TECH TIP!

HATCH COVER KITS The small, 4" diameter, covers are hand sized and are often used behind the rear crossbar for access to the transom. The 5" diameter hatch covers are about the maximum size that the Hobie 14 and 16 foredeck can handle. The 6" access port kit is now a screw-in port, just like the 4" and 5". Prior to 1989, Hobie Cat used a pop-in port on the Hobie 18. Water would seep into the hulls through the rope-handle holes. Replacement with the screw-in ports eliminates that condition.



HOBIE DRY BAG New Hobie Dry Bag 8" diameter x 14". Now a standard feature in all Hobie Kayaks, this new dry bag is built of tough materials. Seals tight to keep your stuff dry.

71703001 8" Hobie Dry Bag



8" TWIST-N-SEAL HATCH



6" TWIST-N-SEAL HATCH

HOBIE TWIST-N-SEAL HATCHES

These new Hobie hatches are designed to have a better seal. The lids also hinge open so you never loose the lid. Designed with a cork-screw-like mechanism, a simple twist of the handle opens or closes the hatch. As the screw pulls down the hatch, you get a tight seal on the "O Ring" seal. Flip the handle into the recess to "lock" it closed. Available in 6" and 8" diameters. These hatches are now standard equipment on all Hobie Kayaks.

71701011 6" Twist-n-seal hatch

71702011 8" Twist-n-seal hatch

HOBIE HATCH BAG Add a drop-in bag to the new 6" Hobie Twist-n-seal hatch. Kit includes back-up ring with lip, screws and bag with drawstring.

5421 6" Hobie Bag Kit



HATCH BAGS Water repellent, durable nylon hatch bags provide secure storage of your wallet, keys, tools, etc. while sailing. Designed to work with screw-in lid type hatches with lip (Kit #5351B-5353W and hatch #V1093-V1146). Simply drop in and they hang from the lip of the hatch cover ring. Available in two styles: the cat bag is a standard cylindrical shape and the fat bag expands to the shape of an inverted hot air balloon.



CAT BAG



FAT BAG

5402 4" Cat Bag

5401 5" Cat Bag

5412 4" Fat Bag

5411 5" Fat Bag

5403 6" Cat Bag

5413 6" Fat Bag



To order from your nearest Hobie Cat dealer
U.S.A. hobiecat.com 1-800-HOBIE-49
Australasia hobiecat.com.au 1-800-4-Hobie



THUNDERWEAR PADDED SAILING GLOVES FINGERLESS DESIGN. All Spandex backs and reinforced Amara grip pads over Amara palms and fingers. The reinforcements have foam inserts to absorb and distribute the loads when "pumping" the sheet ropes. Available in extra-small, small, medium, large & extra-large. (xx = size)

3185XX Gloves



THUNDERWEAR PADDED SAILING GLOVES THREE FINGER DESIGN offers more protection for 3 fingers yet leaves your forefinger and thumb exposed to handle small objects. All Spandex backs and reinforced Amara grip pads over Amara palms and fingers. The reinforcements have foam inserts to absorb and distribute the loads when "pumping" the sheet ropes. Available in extra-small, small, medium, large & extra-large. (xx = size)

3186XX 3 Full Fingers



THUNDERWEAR COLD WEATHER SAILING GLOVES Full fingered glove for watersports. Made of Neoprene and Thunderhide, an amazing synthetic leather that is completely wettable and washable. Keeps your hands warm. These gloves run large and are men's sizes. Available in extra-extra small, extra-small, small, medium, large & extra-large. (xx = size)

3187XX Gloves



HOBIE CAT SAILING GLOVES protect your hands while increasing your grip strength. You must wear gloves to properly control the main and jib sheet. Sliding a line through your bare hands is no fun. Gloves add grip strength against the lines which can ease up on the amount of force you need to exert when sheeting the lines back in. Available in small, medium, large & extra-large. (xx = size)

3188XX HOBIE GLOVE

TECH TIP!

SAILING GLOVES Get a good grip on your lines. Sailing gloves absorb and distribute the sheet rope load, as well as protect your skin from wear and tear. Lower cost gloves are fine for the casual sailor. The more rigorous the sailing conditions the more a higher quality glove is required. Our high end gloves are double thickness leather in high wear areas, padded to spread out the squeeze load on your hand and reasonably easy to get on and off.



MOLDED SHROUD ADJUSTER COVERS Protect hands and feet by covering up sharp edges with these soft vinyl molded adjuster covers. Also great for keeping clevis pin rings from getting snagged and working out of the pin. Sold in pairs.

3261B Black, 12"

WIRE COVERS Standard wires come with molded covers. If your wires are bare you can cover up with these durable vinyl covers for shroud, trapeze wires, stays, etc. Comes in 6 foot lengths. The H16 and H17 shrouds and forestays are 1/8". The H18 shrouds and forestays are 5/32". Many customers prefer to order the next size larger. They will fit just as well and are easier to install.

3252W 1/8" White

3253W 5/32" White



HOBIE STANDARD TEFLON

CHIPS Package of 3 for the Hobie Wave, 14 & 16.

11110005 Package

11110100 100 Pieces

HOBIE WAVE/14/16 MOLDED MAST STEP BEARING

Injection molded Delrin® bearing does not creep or flow out of shape and out of the mast step the way that Teflon chips do.

1130 H14/16



H18 MAST BEARING KIT

For H18. Eliminate that screech when your mast rotates. Get a new bearing with a Teflon™ disk to fit under the bearing.

1132 Bearing & Disk



MOTOR MOUNT WAVE SE Maneuver the Wave in channels, streams or up wind to your favorite beach. Move around with or without the wind. Our easy to install electric motor bracket attaches to the rear cross bar with the trampoline strap.

3183 Motor Mount Only



CHEATA MOTOR MOUNT

Maneuver your boat in channels, streams or up wind to your favorite beach. Move around with or without the wind. Easy to install motor bracket attaches to the rear cross bar.

3180 H14 / WAVE CLUB / H16 / 17

3184 GETAWAY



TELESCOPING PADDLE Measures just 20" in closed position (45" when fully extended). Stows away under the front crossbar or even on the trampoline near the mast! Lightweight, easily portable yet

with durable construction of high grade plastic paddle and anodized aluminum shaft. Corrosion resistant design. Floats too!

3091 Each

ANCHOR KIT

Folding anchor, bag and 60 feet of line.

80035A ANCHOR



RONSTAN CLEARSTART WATCH Multiple start time sequences including the following pre-programmed countdown sequences;

- ISAF 5,4,1,0

- 5 minute periods

- 3 minute periods

- 1 minute periods

Handy 'SYNC' function to re-synchronise with starter's time, mid sequence. Water resistant to 50 meters (164 ft). Optional audible alarms.

12/24 hour time. Multiple mounting options.

Rotating face. Oversized digital read out. Large, positive function keys. Prominent, isolated start/stop button (red Ronstan button).

RF4030 CLEARSTART WATCH



ROOF RACK

PADS Beefy car roofrack

pads, made from durable black polyester with Hobie diamond logo. Easy-on split bottom with Velcro™ closure.

72045 24" Roof Rack Pad (Pair)

72046 36" Roof Rack Pad (Pair)



TIE DOWN STRAPS

Car roofrack tie-down straps, made from durable black polypropylene webbing.

72042 TIE DOWNS 12' (Pair)

STICKERS!!!



12451031

12451031
Hobie Diamond w/ Script" 36"

12451050
"Script" Black 24

12451051
"Script" White 24"



12451050 / 12451051

12453031
Hobie "Teq Sunrise" Dome 4 1/2"

13001001
Hobie "Flying H" Black 12 5/8"

36601000
Hobie "Flying H" Black 6"



12453031



13001001 / 36601000 / 36601011

36601011
Hobie "Flying H" White 6"

79545001
Hobie "H" Dome 2 1/4"



79545001



SAILORS' ALL PURPOSE TOOL Handles screws, bolts, and shackles. Wide blade fits up into Hobie Cat's lower rudder castings for adjusting cam spring tension. Narrow blade fits the rudder stop screw and its built in hook is designed specifically to return locked "down" rudder cams to the "up" position with the twist of the wrist.

83103 Each



EASY RIG Great little temporary handle for halyards, outhauls, downhauls and trampoline tightening. Lay the line in the slot and pull. The line seats in the easy rig handle and provides a handle for tensioning the system. Also available in aluminum from Clamcleat as "Tug Cleat"

2065 Up to 3/16" line

2069 1/4" to 1/2"

2070 Tug Cleat 1/8"-1/4"



STAINLESS STEEL POCKET KNIVES From Telo. Made entirely of top quality stainless steel. Fine quality knives with dura-edged blades. Each has a marlin spike for loosening knots.

STANDARD Marlin spike and single blade. 3.5 oz.

1550 Standard

DELUXE Marlin spike, knife blade, shackle tool, and screwdriver. 4.0 oz.

1551 Deluxe

YACHTSMAN Marlin spike, blade, shackle tool. 2.0 oz.

1555 Yachtsman



GERBER NEEDLENOSE MULTI-PLIER® Since 1939 Gerber has produced high quality innovative products for the outdoors. Features included in this model are; needle nose pliers, wire cutter, crimper, standard/ metric scale, lanyard ring, cross head screwdriver, bottle/can opener, serrated sheeps foot blade, large, medium, and small flathead screwdrivers, file, drop point blade, and it adapts to the Gerber Tool Kit! This Multi-Plier® comes with the S.A.F.T. PLUS™ System where each component opens independently of all others, locks tightly against a positive stop roll bar and stays tight until you unlock it. Stainless steel construction with a limited lifetime warranty!

83102 GERBER TOOL



HOBIE TOOL The must have tool for screw pin shackles, nuts, drain plugs, and some screws. Opens bottles too.

83101 Each



WIRE CUTTER Do it yourself. Precision designed triangular jaws close and cut. No uneven ends.

83105 Each



HOG RING PLIERS Cinch rings, hog rings, upholsterers clamp. They are all the same and these are the pliers to crimp them with. Sailors mostly use them on shockcord.

83104 Each



SWAGE-IT TOOL Make your own wires for those special gadgets you like. Swaging pressure is applied with a box or socket wrench. For 1/16", 3/32", and 1/8" wire sleeves.

83106 Each



To order from your nearest Hobie Cat dealer
U.S.A. hobiecat.com 1-800-HOBIE-49
Australasia hobiecat.com.au 1-800-4-Hobie

**NEW!! HOBIE
BOAT CLEANER AND UV PROTECTANT
SYSTEM: CLEAN AND THEN PROTECT!**



HOBIE BOAT CLEANER – 16OZ Formulated with “Green Chemistry” to safely remove dirt and stains from Hobie products. Good on fiberglass, polyethylene, Vinyl (trampolines) and PVC (inflatables). Cleans the most stubborn stains off of hulls.

7005 HOBIE BOAT CLEANER – 16OZ

HOBIE UV PROTECTANT – 16OZ Protect and rejuvenate fiberglass, polyethylene, vinyl and PVC materials. Spray on, the protectant absorbs into the material and leaves a UV protective layer. Reduce the loss of essential oils and deflect the sun’s harmful UV rays.

7006 HOBIE UV PROTECTANT – 16OZ



polyethylene, polypropylene, vinyl and vinyl coated. TEAR-AID® Type A and TEAR-AID® Type B provide a simple and easy method of patching holes and tears, as well as an excellent protective film solution.

EACH PATCH KIT CONTAINS: (1) 3" x 12" TEAR-AID® Patch that cuts with scissors to any size, (1) 7/8" x 7/8" Patch, (1) 1 3/8" x 1 3/8" Patch, (1) 12" Reinforcement Filament for repairing tears at edges, (2) Alcohol Prep Pads, (1) Illustrated Instructions and a Product Repair List

72020030 TEAR-AID / TYPE A (POLY)

72020031 TEAR-AID / TYPE A (VINYL)

TEAR-AID Each TEAR-AID® repair patch is made from an exceptionally tough, matte finish, abrasion resistant, elastomer that resists puncture and tearing. It is combined with an aggressive adhesive formulated for high bond strength to a variety of surfaces such as canvas, leather, rubber, nylon, most plastics, paints, aluminum, stainless steel, fiberglass, polyurethane,



STARBRITE FIBERGLASS COLOR RESTORER Brings back original color and luster. Removes heavy oxidation, chalking and fading. Protects against future fading. Will not scratch gelcoat. Excellent for all dark colored boats. No hard rubbing is necessary.

1618 16 oz. Bottle

STARBRITE MARINE POLISH During the many months of storage, wind can force dirt into the microscopic pores of your hull and leave the surfaces dull and gritty. To prevent this, an application of Starbrite Marine Polish will seal the hull of your boat and insure a bright and shiny surface when spring comes around. Weather resistant protective coating will keep your hull dirt and stain free.

1611 16 oz. Bottle



FSR Fiberglass Stain Remover, is a unique stain absorbing gel. Ideal for removing oil, rust, exhaust, waterline, and transom stains yet it can also be used anywhere else fiberglass stains may crop up - shower stalls, furniture, etc. Removes road soil. Non-abrasive. Requires no sanding or compounding. Simply apply with a brush, sponge, or cloth, wait a few minutes, then wipe off.

790 One Pint

MAGICA RUST REMOVER

Easily clean rust stains from fiberglass, plastic surfaces, metal parts or fabrics. Although metal parts are made from high quality stainless steel, machining tools often leave carbon particles imbedded in the metal surfaces. This material can bleed a rust stain onto other surfaces. Magica simply dissolves the rust away.



1603 MAGICA GEL
8 oz. Bottle



SEA SPRAY TRAMP CLEANER We've formulated our own trampoline cleaner. It comes in a pump spray bottle so you can apply a light spray to the trampoline, brush and rinse off. It removes dirt, stains, and mildew. Cleans new trampolines and restores old ones.

1619 Tramp Cleaner

SILICONE SPRAY

Dry silicone spray for sail luffs, cleats and bearings

5106 Silicone 8oz Pump



CLEAR SILICONE SEALER Make sure your hulls are watertight! Clear Silicone seals leaks around all thru-

hull fittings such as gudgeons, drain plug housings, tangs, and pylons. Use when re-riveting mast, boom, and crossbar fittings.

376 1.5 oz. Tube



GEL COAT REPAIR KIT

Permanently repairs nicks, gouges and scratches in fiberglass hulls and decks. Blends hundreds of color combinations and cures glass-hard in one hour. Special release paper and no-run polyester gel make a slick, no-sand finish quick and easy. Kit contains colors, polyester gel paste, hardener, release paper, mixing sticks, blending chart and instructions.

1601 Kit

GEL COAT REPAIR PUTTY Use to fill nicks, dings, and scratches. It is the best way to smooth the hull. Blends in perfectly. Will not sag. Must be mixed with catalyst to harden. 1.25 oz. Order catalyst separately.

8006610 White

TWO PART (A&B) EPOXY PUTTY

Simple to use putty-like repair epoxy for cats and all boats. Quick and easy, it works fast to patch up small dings and scratches. Just mix, let dry, sand lightly and you are ready to go.

82300001 1 Pound

VIDEO

SHARING THE WIND & A MOMENT'S GLORY

Sharing the Wind was shot in California and Hawaii. It includes fantastic shots of a Hobie 18 totally airborne flying off the crest of a wave, sailing across a sand bar, triple trapezing, and daggerboard skiing. A Moment's Glory is the 1976 Hobie 16 Worlds in Hawaii off of Diamond Head. (VHS NTSC or DVD format)

- 84430202 DVD** Sharing/Moments
- 84430203 DVD** Hobie Film Festival



DVD - CATAMARAN SAILING, a step by step guide. This new video will introduce you to the thrilling sport of sailing light weight catamarans (Hobie 16 and 18 are featured). Taught in an easy to understand manner, this program provides a boat load of information for beginners as well as seasoned sailors. With an introduction by Jeff Alter, sailing champion Brian Heffernan with the help of some incredible, 3 dimensional graphics, covers these topics: trailering-parts of the boat-rigging-points of sail-sailing in light breezes-sailing in moderate winds-trapezing-capsizing and much more. 45 minute VHS NTSC format. **84430401 DVD**

VIDEO - RICK WHITE'S SAILING SEMINARS Cover all parts of sailing and are great learning tools for the beginner and novice sailor all the way through advanced racer. Total Boat Handling, Upwind and Rolltacking, Great Starts and Finishes, Great Mark Roundings and Downwind Sailing, you will learn everything you need to know. See onboard footage of racers in action. Each video is 30 to 40 minutes in length. VHS / NTSC Format Each

- 84430411 #1 Boat Handling**
- 84430412 #2 Upwind Sailing**
- 84430413 #3 Starts & Finishes**
- 84430414 #4 Mark Roundings**
- 84430415 #5 Downwind Sailing**



VIDEO CATAMARAN RACING Whether you're just starting out sailing catamarans, or an experienced competitor, Catamaran Racing will provide you with helpful information. Topics included: Your first regatta, Course Layout, Starting Technique, Rules, Mark Rounding, Launching through surf, Racing Strategies and many more. Whether you're a pro looking for a few pointers to increase your success on the race course, or a beginner wondering how to get involved in racing, this tape gives you the answers. (VHS NTSC format)

84430451 Catamaran Racing Video



VIDEO FACTORY SUPPLIED RIGGING Learn How-to Assemble Your Hobie Via Video. Pictures Are Said To Be Worth A Thousand Words Well, How About Video! Straight Forward Assembly Instruction Takes You From Trailer To Ready To Sail! Learn The Correct Way And Faster Rigging Techniques. The Hobie 18 Video, Catamaran Sailing "A Step By Step Guide", Is Much More Complete And Includes All Aspects Of Sailing Cats. You Should Order This One Along With Your Boat's Specific Video For Complete Catamaran Instruction. Not Shown.

- 84430023 Wave (DVD)**
- 84430128 Getaway (DVD)**
- 84430026 14/16 (DVD)**
- 84430027 17/Sport (VHS)**

86110000 Decal - HCA Course Chart
86120000 Decal - HCA Racing Flags
86200000 Decal - World Hobie Class Association (From the history archives!)

BOOKS

CAT SAILING By Phil Berman. This book covers rigging, heavy weather sailing, tuning, racing, surfing, maintenance, and trailering.

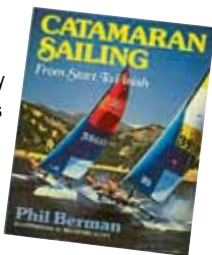

610 Cat Sailing

CATAMARAN RACING FOR THE 90'S By Rick White of "Rick White Sailing Seminars". Twenty one major subjects with whole chapters devoted to the start, each race course leg, sail shape, mast rake, etc. Special chapters written by Hobie Alter Jr., Bob Curry, Wayne Schafer, Carlton Tucker, Randy Smyth and several other experts. 352 pages.



614

THE CATAMARAN TUNING GUIDE By Michael Fragale, edited by Rick White and Mary Wells. Want to sail faster? Whether you're a beginning sailor or a class champion, this book will help take you to the next level.

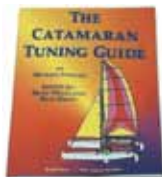

607 Tuning Guide

SAILING DRILLS Rick White's Sailing Seminars have compiled all of the drills they have used. Coupled with ideas and knowledge from some of the worlds best sailors these drills take sailing and dissect it into pieces.



609 Sailing Drills



ASSEMBLY MANUALS

- 13450000 H14**
- 37450011 Getaway**
- 23450000 H16**
- 33450001 H21**
- 36450000 H21SC**
- 38450000 WAVE**
- 43450001 H20**
- 50450001 H17**
- 52450011 SPORT**
- 63450000 H18**
- 11720000 Learn to Sail**



For information on joining the Hobie Class Association of North America, contact hobiemembership@gmail.com or hca-na.org



It's the Hobie Way of Life!

"The Hobie Way of Life" summarizes how fleet members and their families feel about a sailboat that gives them an irresistible sense of freedom, camaraderie, excitement and fun. Hobie Catting means instant friendships with other Hobie sailors. Enjoying a fleet picnic, participating in summer evening practice races, attending a points regatta or joining an overnight flotilla puts you with people who share your same fun-loving interests.

Hobie Cat Racing

Hobie Cat regattas take place almost year round all over the continent—weather permitting. Most local fleet events take place on weekends during the summer months. There are usually 4-6 races on a Saturday and 2-3 races on Sunday. Information about each Division's schedule is available in the newsletter and on the HOBIE CLASS website. Hobie Cat racers are welcome to participate in any Hobie event, regardless of whether it's in their home Division or in another area.

Racers are required to be HOBIE CLASS members if they wish to take part in HOBIE CLASS sanctioned points regattas.

Hobie regattas are run on a standard sailing race course and follow ISAF racing rules as published by US Sailing in North America. Individual fleets are permitted to make minor procedural changes by amending the sailing instructions.

The beauty of a Hobie regatta is its one-design nature. All the boats are Hobie Cats. Starts are sequenced according to size of the boat. The race committee makes the decision about the starting order at a regatta, but the following is how it generally goes: The H-20s start first and sail a longer course than the other boats because they go faster. The H-18s would probably start 2nd, followed by the 17s, then the 16s and 14s. Within each class (or size) of boat there can be A, B, or C fleets. These designations refer to the race experience of the skipper. An "A" fleet skipper has the most experience while a "C" fleet skipper is just learning about Hobie racing. Oftentimes "C" fleeters start after the "A" and "B" boats, and sail a shorter course. A racer moves up through the fleets by improving during a regatta season. The Division leadership looks at all the race results at the end of the year and promotes the top sailors. Once you get to "A" fleet, you are considered to be skilled enough to compete at the regional, continental and global level.

Hobie Cat Sailboats

Hobie Cat produces a variety of catamaran (twin hull) boats. Each one was designed to satisfy a specific niche in Hobie racing and pleasure sailing.

The HOBIE CLASS Organization

The Hobie Class Association of North America was established to serve Hobie Cat sailors and racers residing within North America, including Canada, Mexico, Puerto Rico, El Salvador, Guatemala, and the United States. The purpose of the HOBIE CLASS is to establish and promote the highest standard of Hobie Cat sailing/racing in its geographic boundaries in collaboration with the National and International sailing authorities.

HOBIE CLASS's purpose is to

- Give support and encouragement to Hobie Cat sailors, racers, boat/equipment dealers and the manufacturer;
- Support and maintain the one-design racing characteristics of the Hobie Cat sailboat;
- Promote Hobie Cat sailing/racing activities to HOBIE CLASS members including regatta organization and publicity;
- Uphold the rules governing Hobie Cat racing competitions provided by the International Hobie Class Association and the International Sailing Federation;
- Provide educational opportunities for training and racing skill improvement of HOBIE CLASS members through seminars like the Guest Expert Program; and
- Foster and encourage youth sailing with specialized training and coaching programs.

HOBIE CLASS MEMBERSHIP is open to all persons interested in the sport of Hobie Cat sailing. There are 16 Divisions in distinctive geographic areas across North America. Each Division is composed of several Fleets of sailors within smaller geographic areas. Hobie Cat fleets are not typically associated with yacht clubs. Please refer to the map and fleet listing found in HOBIE CLASS News, visit the website www.hca-na.org or call Hobie Cat at (760) 758-9100 x0 to find a fleet near you. **Join the fun today!**

Useful websites for additional information - North America: hca-na.org International: hobieclass.com Hobie Cat Company Site: www.hobiecat.com

HOBIE CAT

ILLUSTRATED PART GUIDES

BRAVO, WAVE, GETAWAY, 14, 16, 17, 18 & 20

All Illustrated Part Guides, including Tiger, Fox, H21SE, Sport Cruiser, Trifoiler, Hobie One/Holder are available online in our support and parts sections.

hobiecat.com/support

Be sure to see the Hobie Sailor forums for online technical help. This includes an FAQ section and many ongoing technical and sailing topics.

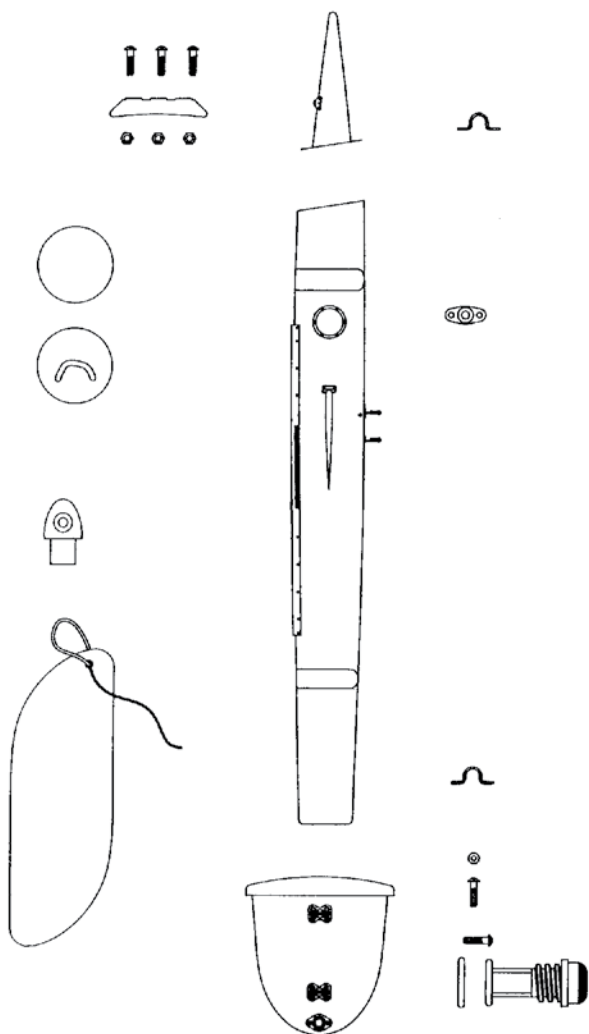

HOBIE CAT WARRANTY

HOBIE PARTS WARRANTY Hobie Cat warrants all Hobie Cat manufactured parts and accessories against failure due to materials or workmanship defects for a period of one year.

OTHER WARRANTY Any accessories and other merchandise sold by Hobie Cat not mentioned in the paragraph above are not warranted by Hobie Cat. Said accessories and other merchandise may be covered by the manufacturer's warranty, a copy of which can be furnished by Hobie Cat upon written request.

HOBIE CAT'S OBLIGATION Hobie Cat at its option will repair or replace without charge any part or accessory which is found to be defective under the terms and within the period of this Warranty. Buyer must return the accessory with a sales slip as proof of purchase date.

BUYER'S OBLIGATION Promptly, upon discovery of a suspected defect, buyer, at its expense, must return the equipment to the Hobie Cat dealer for inspection. Warranty is void if equipment is operated after a suspected defect is, or should have been discovered.

WHO IS ENTITLED TO WARRANTY Only the original Buyer of the equipment and accessories from Hobie Cat is entitled to warranty. Warranty may not be transferred.

NO WARRANTY OF USED EQUIPMENT Used equipment is sold AS IS; Hobie Cat makes NO WARRANTY concerning its merchantability, condition, durability, age or model year, or fitness for any purpose whatsoever.

MUTUAL AGREEMENTS It is agreed that this warranty sets forth Buyer's exclusive right and remedy against Hobie Cat with respect to the equipment and accessories. It is in lieu of all other express warranties and all implied warranties, including implied warranties of merchantability and fitness. Hobie Cat assumes no other like or unlike liability for loss of cargo, use, profit or consequential damages of any kind in connection with the sale, alteration, use, repair or replacement of equipment or any part thereof.

HOBIE BRAVO

REPLACEMENT HULL - 90010000

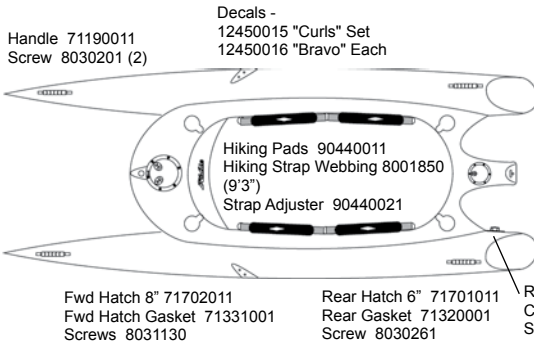

RUDDER ASSEMBLY - EZ LOC 90312000

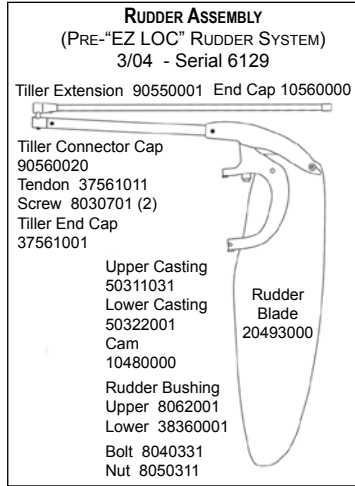
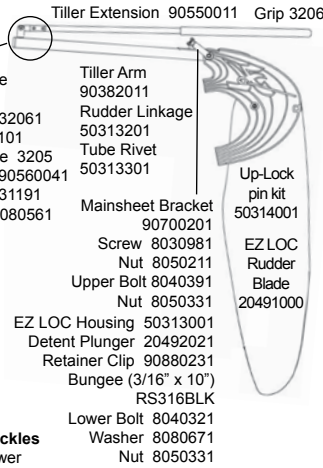

"A" Frame Vertical Support Assy Serial Numbers 702 - Higher 90710000 Serial Numbers 701 - Lower 90710011

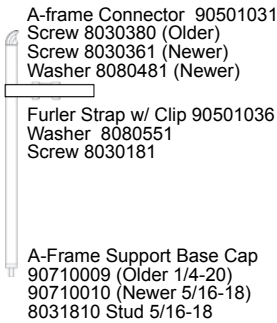

Bravo Mast Float w/Starps and Buckles 90600011 Hull # CCMQ1028 - Lower 90600012 Hull # CCMQ1029 - Higher

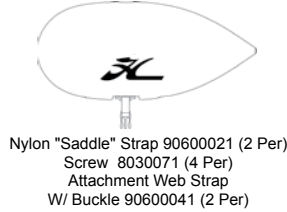

MAST

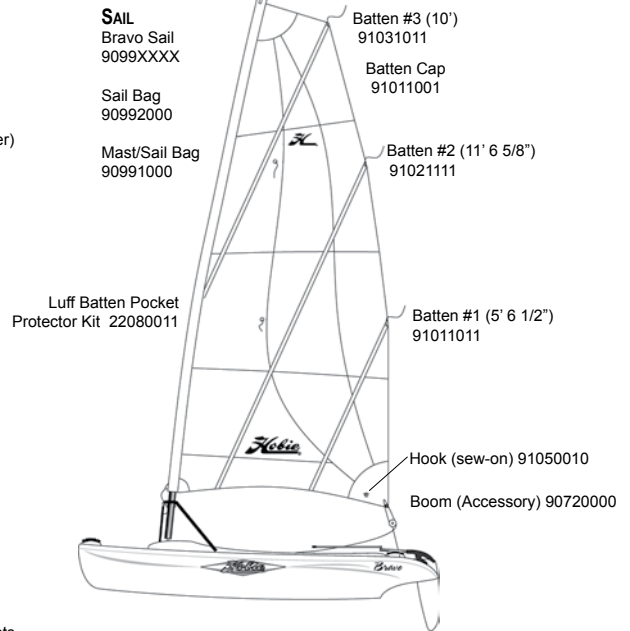
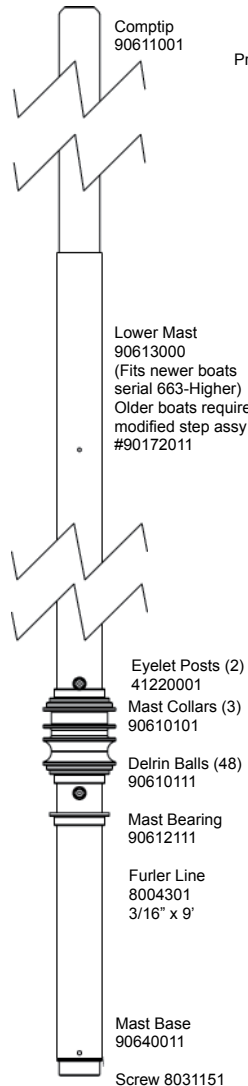

A-FRAME

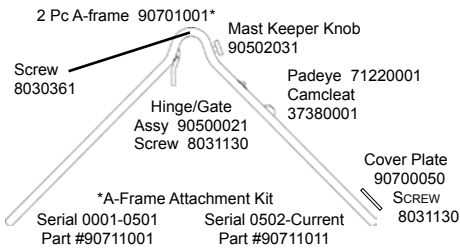

MAST STEP ASSY

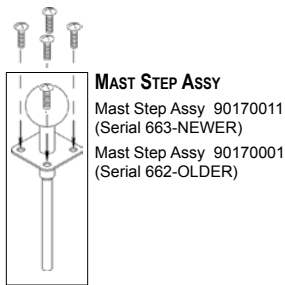

Mainsheet System

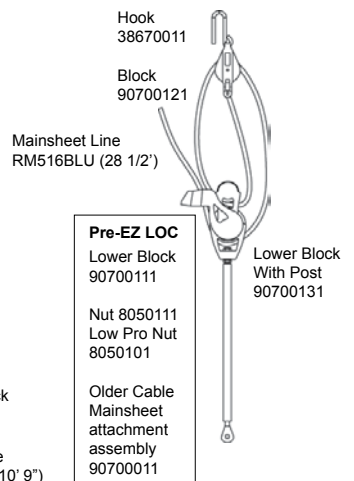

RIGHTING LINE

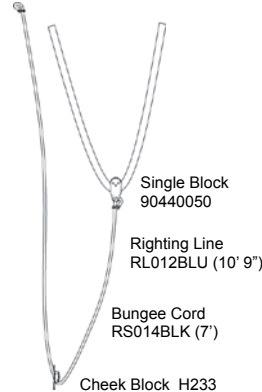

BRAVO RIVET GUIDE

() Indicates quantity need to fasten part

Mast

Comptip Notch 8010181(1)
Collars 8010131 (4/collar)
Eyelet Posts 8011231 (1/post)

A-Frame

Gate Hinge 8012062 (1)
Padeye 8010131 (2)
Cam Cleat 8010131 (2)

Vertical Support Tube

Base 8010181 (4)
Webbing Strap 8010181 (2)
A-frame Connector 8010131 (2)

Rudder

Upper Casting 8010131 (3)
Tiller End Cap 8010131 (2)
Bravo Extension Cap 8010181 (1)

Boom

End Cap 57130000(2)
Boom Cap Casting 8010131 (2)
Padeyes 8010131 (2/padeye)
Cam Cleat 8010131 (2)

HOBIE WAVE

REPLACEMENT HULL - LEFT 39010001
 REPLACEMENT HULL - RIGHT 39020001

WAVE VERSION NOTES:
STANDARD WAVE / CLASSIC OR "SE" - (CAR TOPPABLE) ONE PIECE TRAMPOLINE, SHROUDS AND BRIDLES CONNECT WITH HOOKS
CLUB WAVE - THREE PIECE TRAMPOLINE. SHROUDS AND BRIDLES CONNECT WITH CLEVIS PINS
CLUB items listed only if different from standard SE wave model.

CLASSIC / SE WAVE

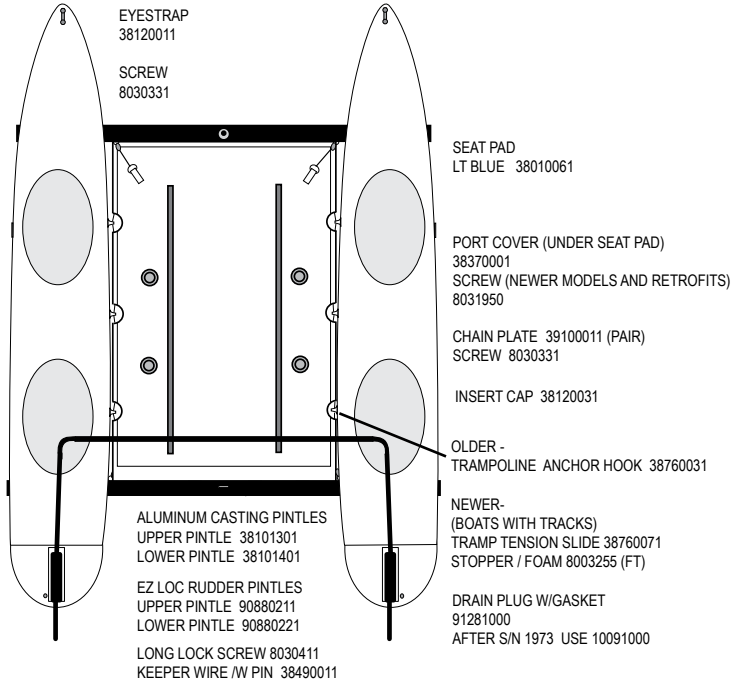

'97-NEWER (SN 1438-ABOVE)
FORWARD CROSSBAR 38131041

MAST STEP CASTING 38171001
POST (THREADED) 38170001
BALL 50212301
BASE STEP PIN 8020451

'96-OLDER
MAST STEP CASTING 10170011
MAST STEP LINK KIT 21380001
BLACK FORWARD END CAP 39130021

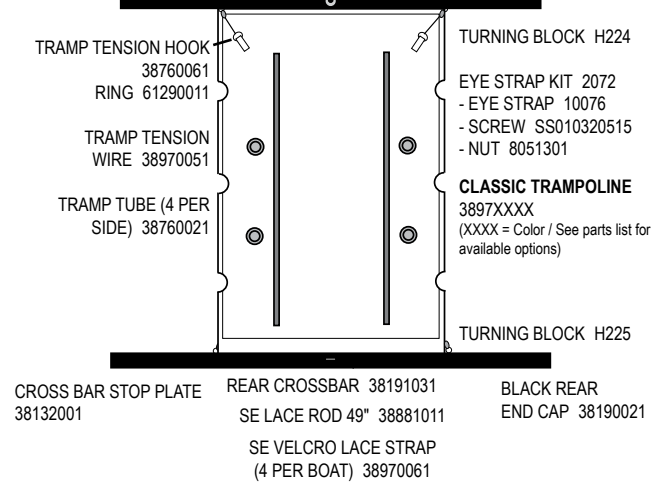

ACCESSORIES

BOW SPREADER 38999021
END CAP 38950011
BOW SPREADER TANG 38120041

SEAT BACKREST KIT 38040011
BACKREST INSTALLATION QUICK PIN 8020181
BACKREST PLUG, FORWARD 38660011
BACKREST PLUG, AFT 38660031

MAIN TRAVELER KIT (CLUB) 39250000

CLUB WAVE

(CLUB WAVE VERSION-ITEMS LISTED BELOW ONLY IF DIFFERENT FROM STANDARD WAVE MODEL.)

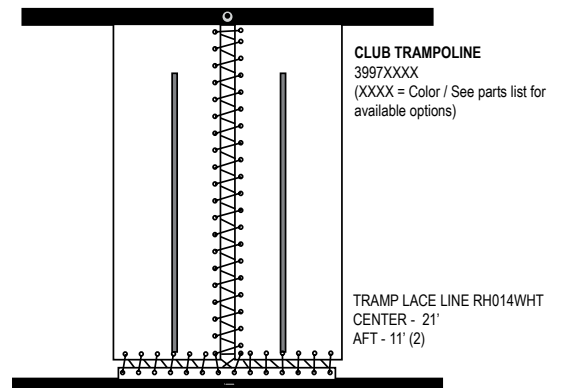
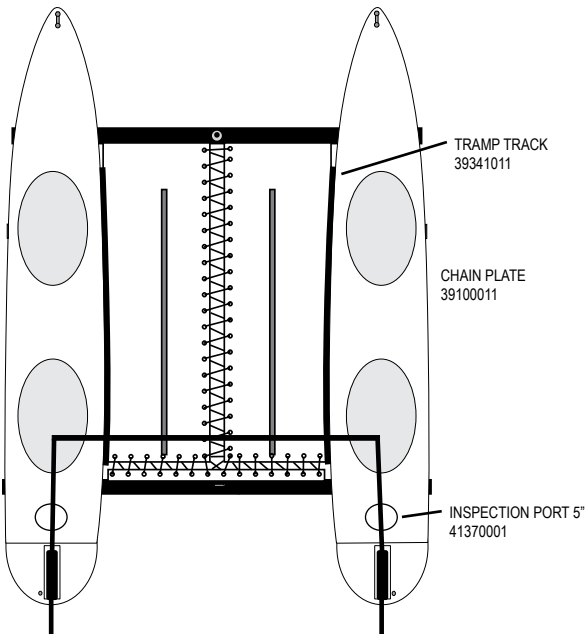

TILLER CROSS BARS

- 39521001 CLUB BOLT (62")
- 39522001 TENDON (62")
- 39524001 '07 EZ LOC (67")

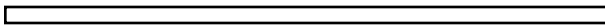

EZ LOC RUDDER ASSEMBLY
39312000

RUDDER ASSEMBLY
Pre-"EZ LOC" Rudder System

* = SUB ASSEMBLY PART / INCLUDED WITH CASTING

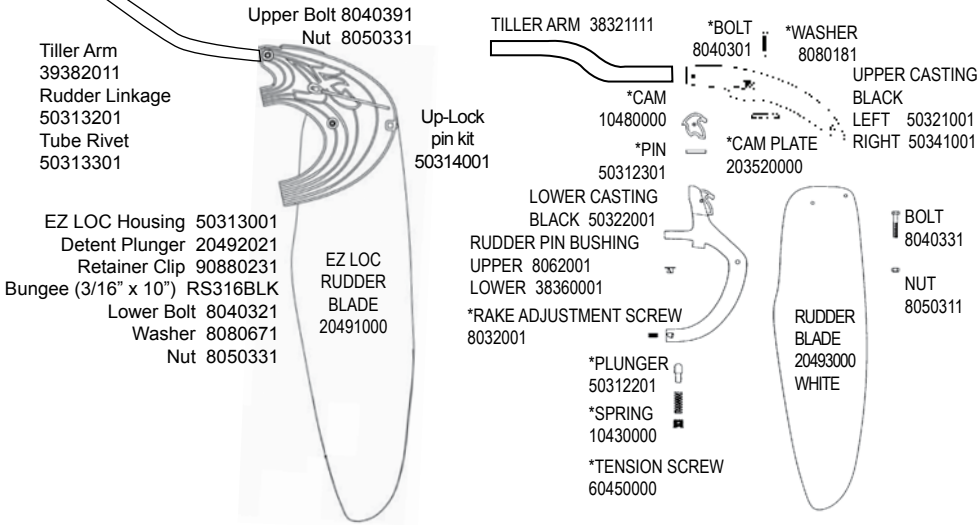

- FLOAT KIT 30115
- BRACKET (1) 39640020
- SCREW 8032011
- MAST HEAD 10602111

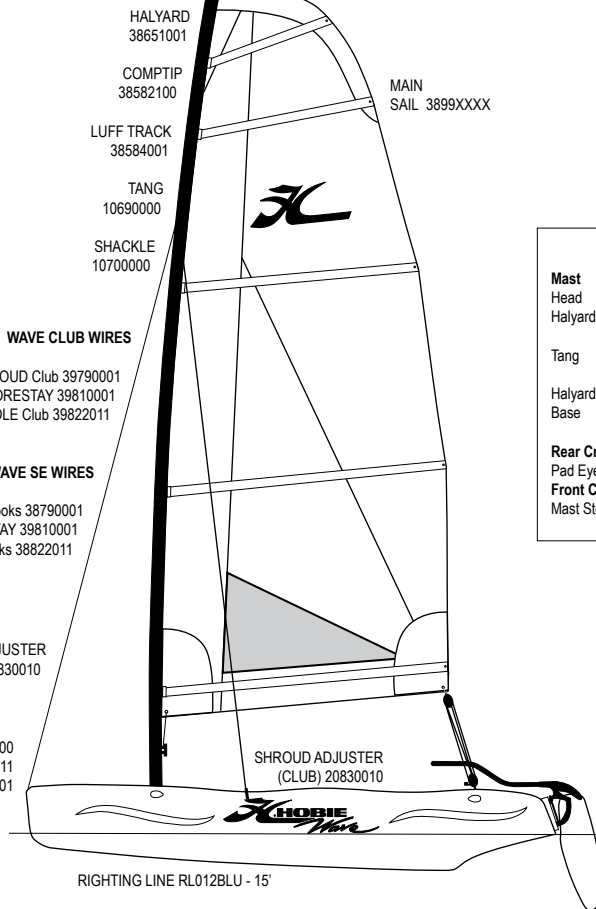

MAST

SERIAL NUMBER 0 THROUGH 1437
OLD ASSEMBLY NLA (SEE NEW STYLE BELOW) CONVERSION REQUIRES MAST STEP RETROFIT.
MAST BASE (HOBIE14 STYLE) 10640011

SERIAL NUMBER 1438 AND NEWER
MAST ASSEMBLY (NEW STYLE) 38581041
LOWER MAST 38583141
NEW MAST BASE (CUP) 38641001

MAST STEP PARTS

- (*Conversion parts required to retrofit new mast to old style boat):
- *NEW STEP BALL 50212301
- *NEW STEP POST 38170001
- *NEW MAST STEP CASTING 38171001 (Flat top / threaded for post)
- *RIVET (4) 8011231
- *STEP PIN -8020451

WAVE CLUB WIRES

- SHROUD Club 39790001
- FORESTAY 39810001
- BRIDLE Club 39822011

WAVE SE WIRES

- SHROUD SE w/Hooks 38790001
- FORESTAY 39810001
- BRIDLE SE w/hooks 38822011

TILLER CONNECTOR KITS AND PARTS

1957 KIT - '07 TILLER CONNECTOR

1956 KIT - CLUB TILLER CONNECTOR (REPLACES TENDON STYLE WITH CLUB BOLT STYLE)

1954 KIT - CLUB TILLER CONNECTOR / UPGRADE FOR EARLY BOATS WITH ORIGINAL CURVED TENDON CONNECTORS: INCLUDES TILLER CROSS BAR AND ALL TILLER CONNECTOR FITTINGS

'07 TILLER CONNECTOR (1957)

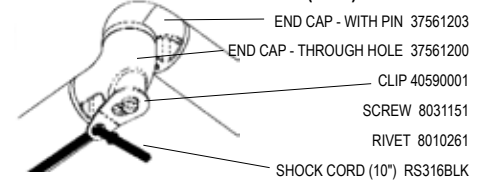

CLUB TILLER CONNECTOR (1954 / 1956)

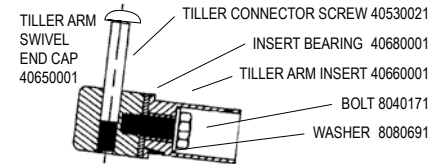

TENDON TILLER CONNECTOR

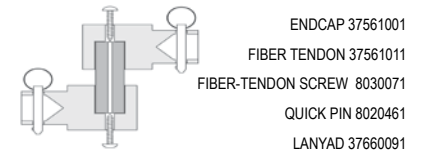

- BATTEN #5 36"
- BATTEN #4 50"
- BATTEN #3 66 7/8"
- BATTEN #2 77 7/8"
- BATTEN #1 82 3/8"

38016001 HOBIE WAVE BATTEN SET

(FOR INDIVIDUAL BATTENS SEE UNIVERSAL BATTENS ON PAGE 14)

Wave Rivet Guide () Quantity needed to fasten part

Mast	Rudder Assembly	Sail
Head 8010131 (2)	Upper Casting 8010131 (2)	Headboard 8010020 (16)
Halyard Hook 8010181 (2)	(Underside) 8011231 (1)	Tack/Clew plate 8010020 (6)
8011291 (2)	Tiller End Cap 8010131 (2)	Pocket Protector 8010020 (4)
Tang 8010181 (6)		(Requires setting machine-not available as hand tool)
8011291 (6)		
Halyard Cleat 8010121 (2)		
Base 8010131 (3)		
Rear Crossbar Pad Eye 8010181 (2)		
Front Crossbar Mast Step 8011231 (4)		

- "S" HOOK 38900031
- SHACKLE 11220000

- UPPER BLOCK 38900061

RM516BLU X 35'

- LOWER BLOCK 38900071

HOBIE GETAWAY

REPLACEMENT HULL - LEFT 37010001
 REPLACEMENT HULL - RIGHT 37020001

COOLER LID 37370021
 MOUNT GASKET 37370031
 SCREWS 8031151
 5" DECK PLATE 41370001 CHAIN PLATE 39100011 (PAIR)

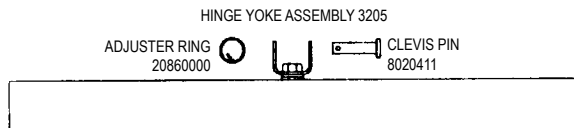
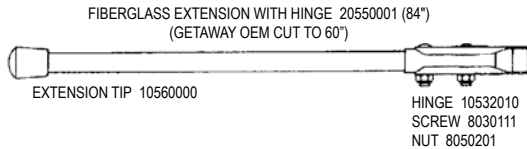
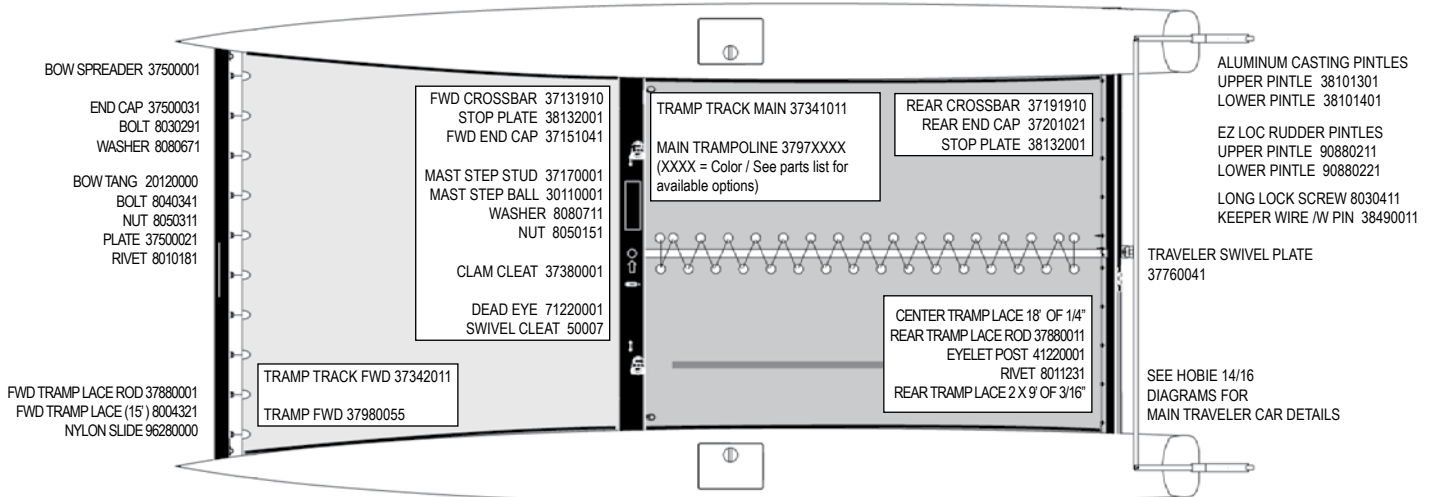

TILLER CROSSBAR 37521001 (M20 STYLE)
 TILLER CROSSBAR 37522001 (TENDON STYLE)
 TILLER CROSSBAR 37523001 (EZ LOC / TENDON)
 TILLER CROSSBAR 37524001 (EZ LOC / '07)

RUDDER ASSEMBLY - EZ LOC 37312000

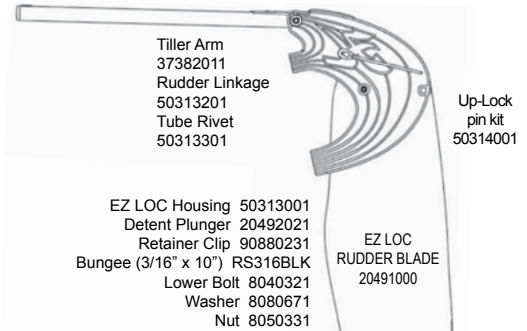

TILLER CONNECTOR KITS AND PARTS

1957 KIT - '07 TILLER CONNECTOR
 1956 KIT - CLUB TILLER CONNECTOR
 (REPLACES TENDON STYLE WITH CLUB BOLT STYLE)

'07 TILLER CONNECTOR (1957)

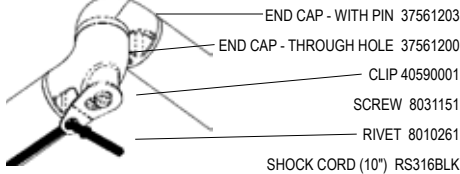

CLUB TILLER CONNECTOR (1956)

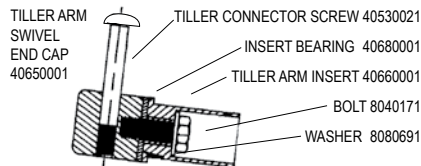

TENDON TILLER CONNECTOR

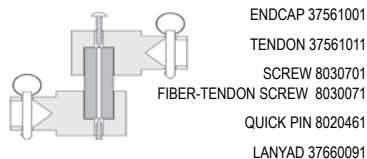

RUDDER ASSEMBLY - Pre "EZ LOC" * = SUB ASSEMBLY PART / INCLUDED WITH CASTING

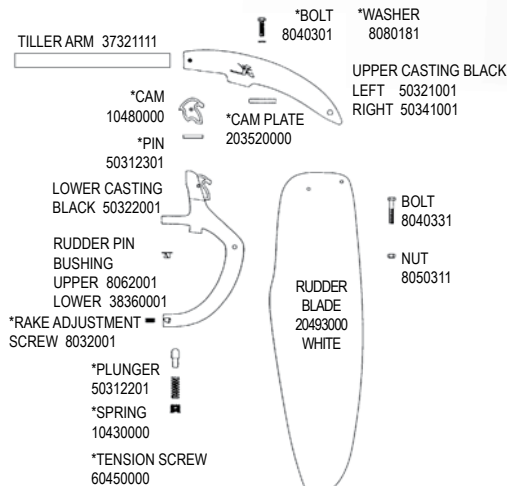

MAST ASSEMBLY
37610000

MAST HEAD
37601001

COMPTIP
37611100

LUFF TRACK
37611151 (102")

HALYARD
37651001

TANG
20690000

SHACKLE
20700001

LOWER MAST
37583141

DOWNHAUL /
HALYARD CLEAT 10730000
SCREW 8030111
NUT 8051301

MAST BASE
37641001

STEP PIN
8020451

MAST TANG 20690000
SHACKLE 20700001

WIRES

FORESTAY ASSY 37810001

FORESTAY ASSY INCLUDES:
*SHACKLE W/KEEPER WIRE #20700001
*SWIVEL #61230000
*YOKE #37810030
*SCREW #HSPAP
*LOCK NUT #8050111
*LOWER FORESTAY #37810021

SHROUD 37790001

TRAPEZE KIT 37140001

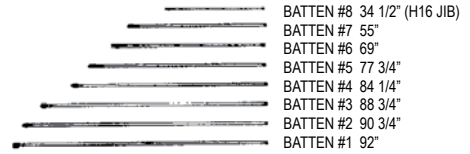

37016001 BATTEN SET
(FOR INDIVIDUAL BATTENS SEE UNIVERSAL BATTENS ON PAGE 14)

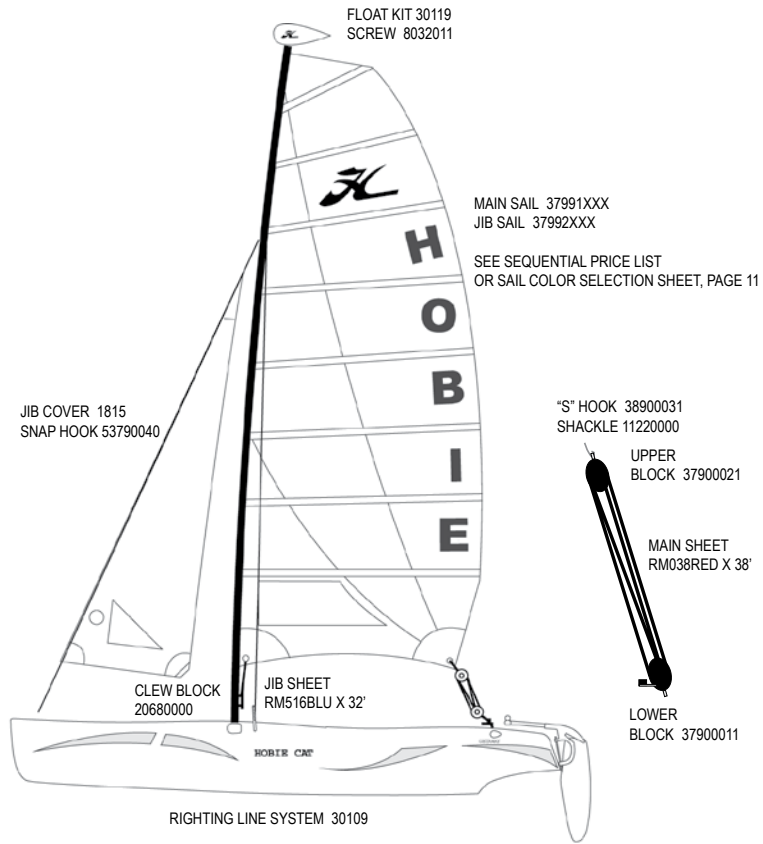
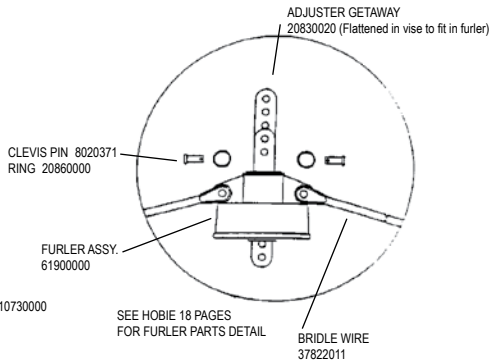
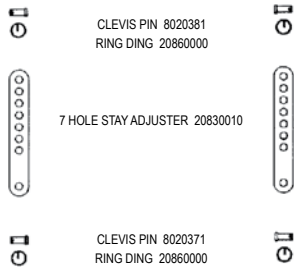

37001000
GETAWAY WING ASSEMBLY

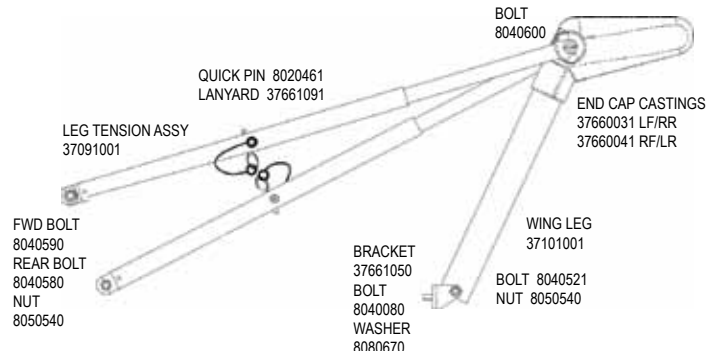

HOBIE H14 / H16

REPLACEMENT HULL H16 WHITE - LEFT 25010001
 REPLACEMENT HULL H16 WHITE - RIGHT 25020001

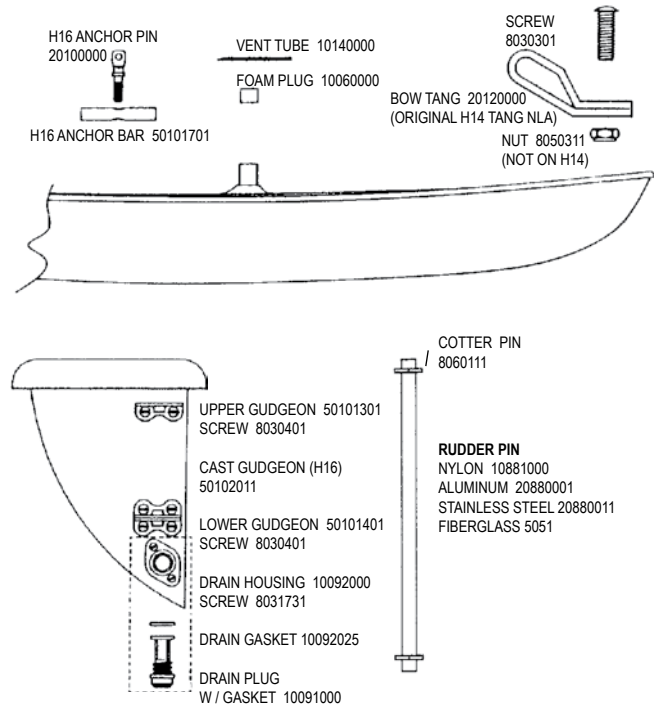

H14 / H16 TRAMPOLINE, SIDEBAR

H14 COMPLETE TRAMPOLINE
 (Does not include lace lines)
 1097XXXX
 (XXXX = Color / See parts list for available options)

H16 COMPLETE TRAMPOLINE
 (Does not include lace line)
 2097XXXX
 (XXXX = Color / See parts list for available options)

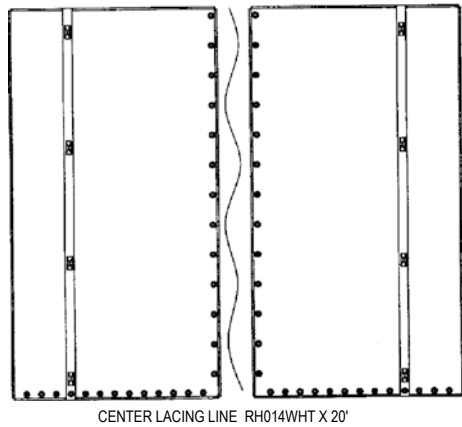

H14 / H16 FRONT CROSSBAR

H14 BLACK FRONT CROSSBAR W/MAST STEP 10131910
 H16 BLACK FRONT CROSSBAR W/MAST STEP / INTEGRATED TRACK 25131910

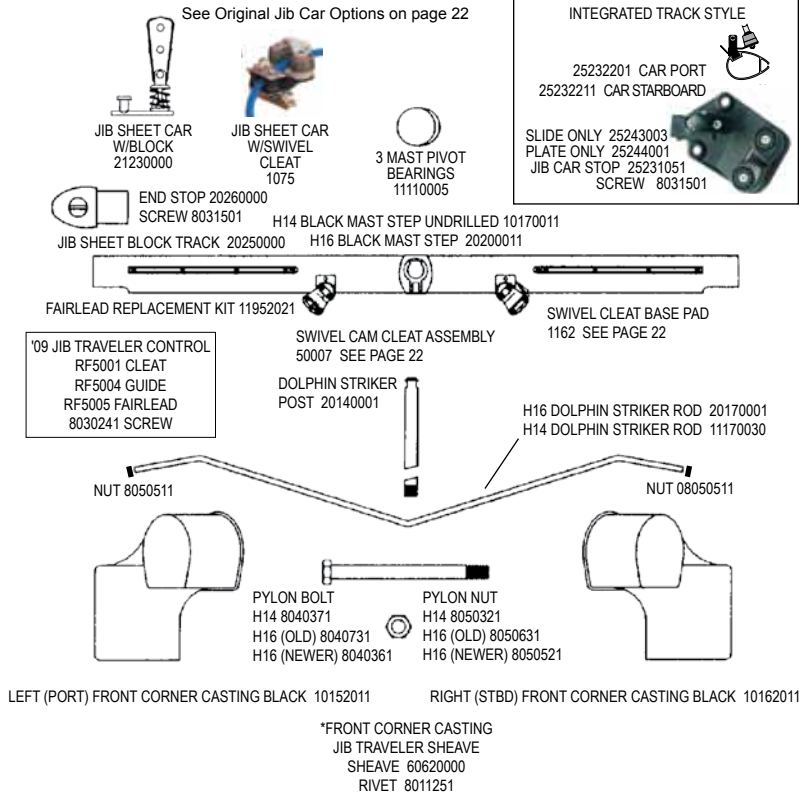

* Starting in '95 boats had newer style castings / pylons.

H14 / H16 REAR CROSSBAR

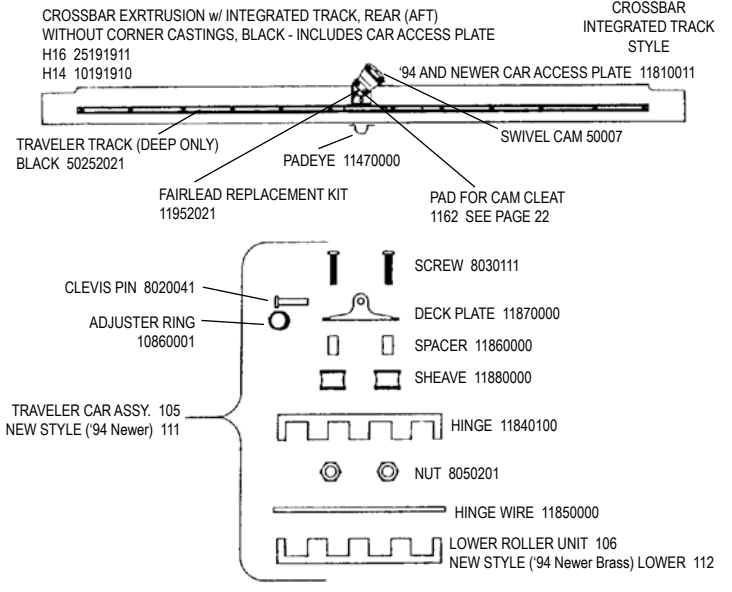

* Not all '94 boats had newer style castings / pylons.

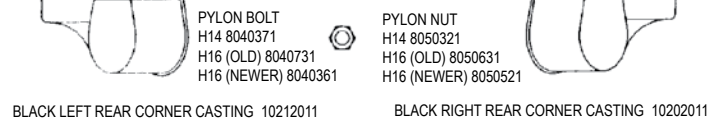

H14 / H16 RUDDER

* = SUB ASSEMBLY PART / INCLUDED WITH CASTING

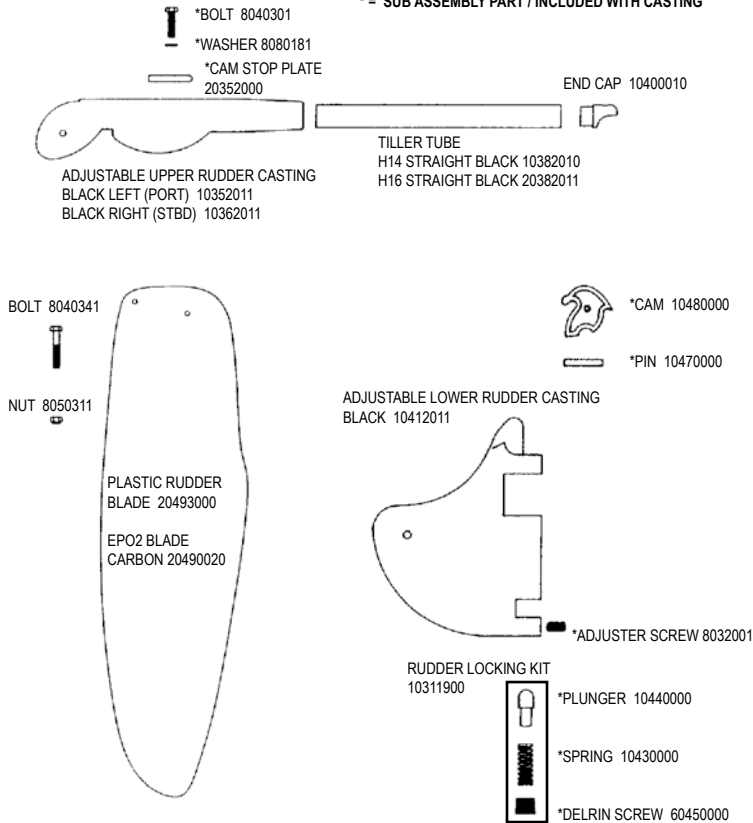

H14 / H16 TILLER CROSSBAR

H14 TILLER CROSSBAR BLACK 10520011
 H16 TILLER CROSSBAR ORIGINAL BLACK 20520011
 *H16 95 - NEWER 20521001

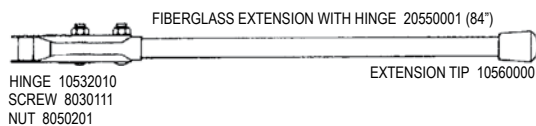
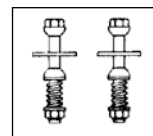
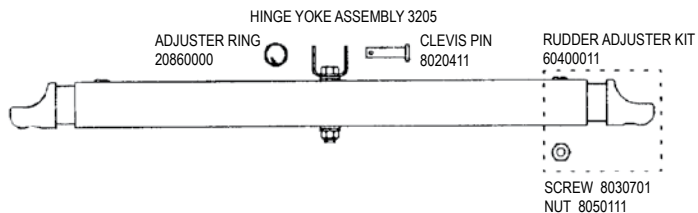

H14 / H16 MAST

H14 COMPLETE MAST ASSEMBLY BLACK 10581100
 H14 COMPTIP ASSEMBLY 10582100
 H16 COMPLETE MAST ASSEMBLY BLACK 20610000
 H16 COMPTIP ASSEMBLY 20611100

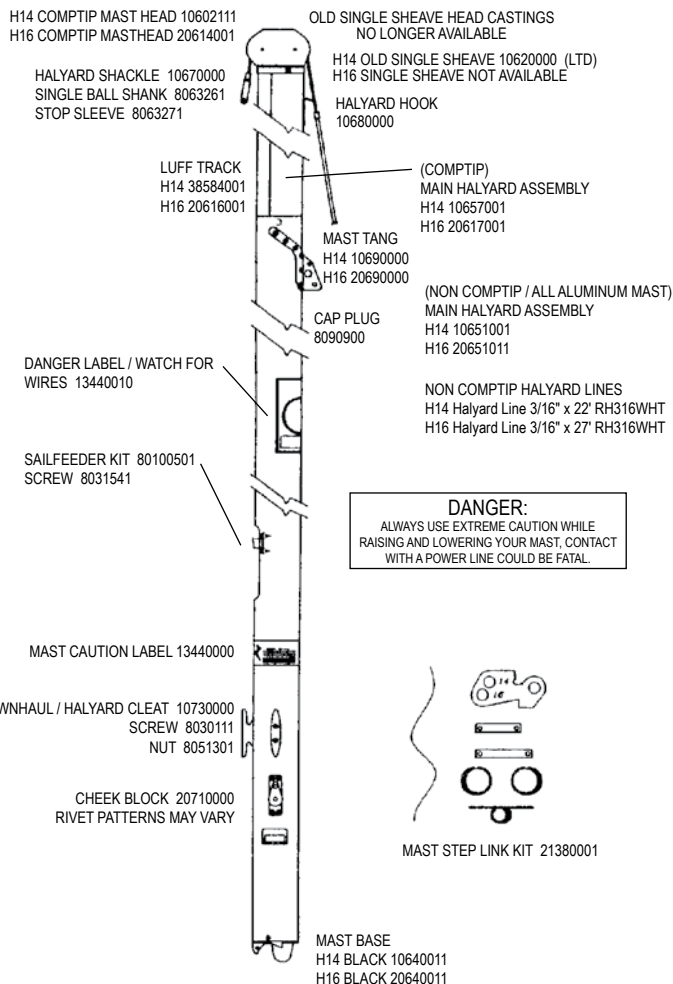

H14 Rivet Guide		H16 Rivet Guide	
() = Quantity needed to fasten part		() = Quantity needed to fasten part	
Mast		Mast	
Head	8010131 (2)	Head	8010131 (4)
Halyard Hook	8010181 (2)	Halyard Hook	8010181 (2)
	8011291 (2)		8011291 (2)
Tang	8010181 (6)	Tang	8010181 (12)
	8011291 (6)		8011291 (12)
Halyard Cleat	8010121 (2)	Halyard Cleat	8010121 (2)
Base	8010131 (3)	Base	8010131 (3)
Sidebar		Downhaul Cheek Block	8010181 (4)
Chain Plate	8010181 (3)	Front Crossbar	
Rear Crossbar		Corner Casting	8011231 (6)
Corner Casting	8011231 (6)	MAst Step	8011231 (4)
Traveler Track	8010201 (18)	Jib Track	8010201 (6)
or	8010161 (18)	Swivel Jam Cleat	8010201 (1)
Pad Eye	8010181 (2)	or	8010131 (1)
Swivel Jam Cleat	8010201 (1)		8031501 (2)
	8031501 (2)		8031231 (1)
	8031231 (1)		8050801 (1)
	8050801 (1)		8080101 (1)
	8080101 (1)	Rudder Assembly	
Boom		Upper Casting	8010131 (2)
Front End Cap	8010131 (3)	(underside)	8011231 (1)
Tang	8010181 (4)	Tiller End Cap	8010131 (2)
Barrel Cleat	8010181 (2)	Boom	
Block Hanger	8010181 (4)	Front End Cap	8010131 (3)
Rear End Cap	8010131 (3)	Tang	8010181 (4)
		Barrel Cleat	8010181 (2)
Front Crossbar		Block Hanger	8010181 (4)
MAst Step	8011231 (4)	Rear End Cap	8010131 (2)
Corner Casting	8011231 (6)	Rear Crossbar	
Rudder Assembly		Corner Casting	8011231 (6)
Upper Casting	8010131 (2)	Traveler Track	8010201 (20)
(Underside)	8011231 (1)	Pad Eye	8010181 (2)
Tiller End Cap	8010131 (2)	Swivel Jam Cleat	8010201 (1)
			8031501 (2)
Sail			8031231 (1)
Headboard	8010020 (16)		8050801 (1)
Tack/Clew plate	8010020 (6)		8080101 (1)
Pocket Protector	8010020 (4)	Sail	
(Requires setting machine-not available as hand tool)		Main Headboard	8010020 (16)
		Tack/Clew Plate	8010020 (6)
		Main Pocket Prtc	8010020 (4)
		Jib Clew Plate	8010020 (16)
		Jib Pocket Prtc	8010020 (3)

H14 / H16 FORESTAY ASSEMBLIES

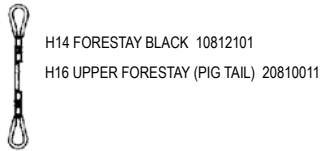

H16 JIB HALYARD AND LOWER FORESTAY

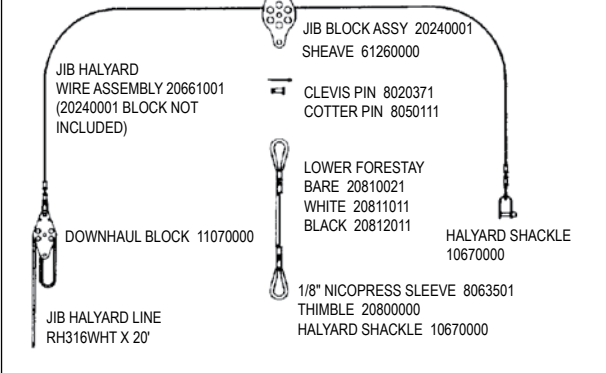

PIN AND RING SET 30303
SEE PAGE 27

CLEVIS PIN 8020381
RING DING 20860000

10 HOLE STAY ADJUSTER 20830020

H14 BRIDLE BLACK 10822101

H16 BRIDLE WHITE 20820011
H16 BRIDLE BLACK 20822011



SHACKLES (FOR H14 WITH BOW PLATES) 10870000

H16 "AUSSIE" FORESTAY AND JIB HALYARD

80660000 Assembly

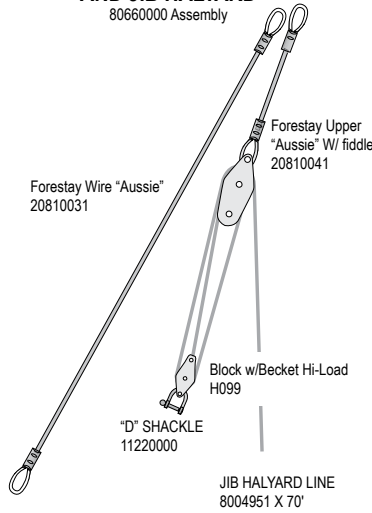

H14 / H16 SHROUDS

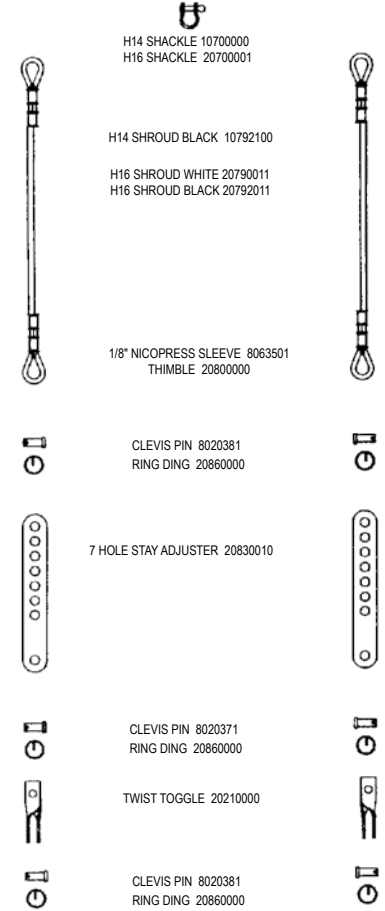

H16 TRAPEZE

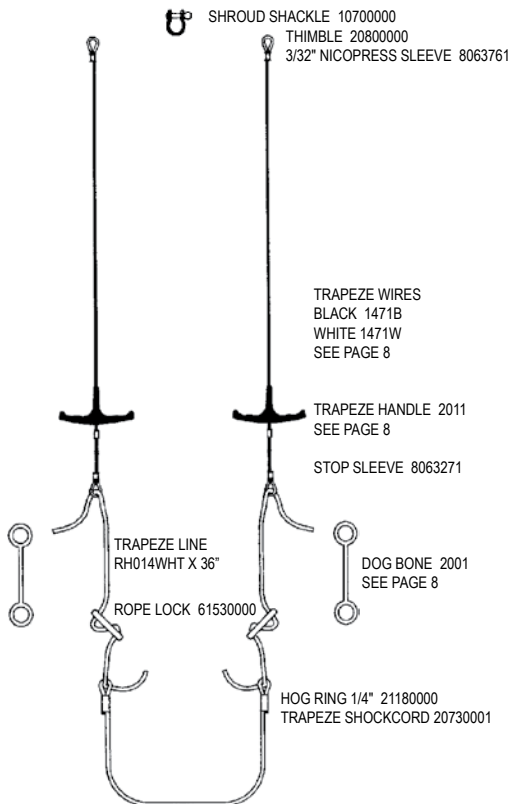

H14 TURBO RIGGING KIT

TURBO RIGGING KIT 80200000

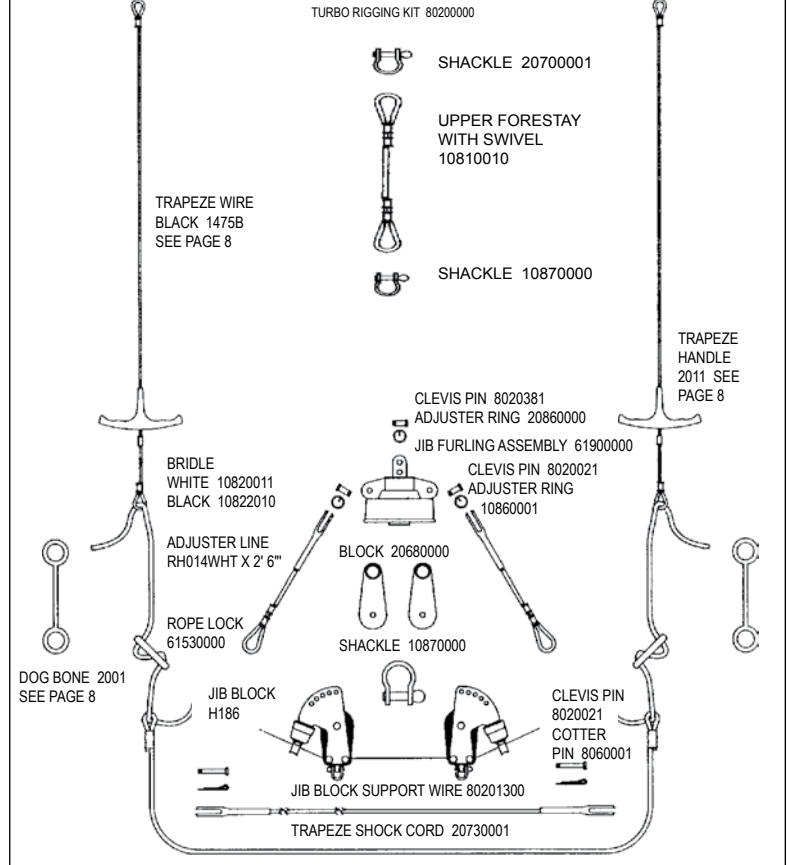

H14 / H16 MAIN SAIL & BATTENS

H14 MAIN SAIL 1099XXX
H16 MAIN SAIL 20991XXX
SEE SEQUENTIAL PARTS LIST
OR SAIL COLOR SELECTION SHEET

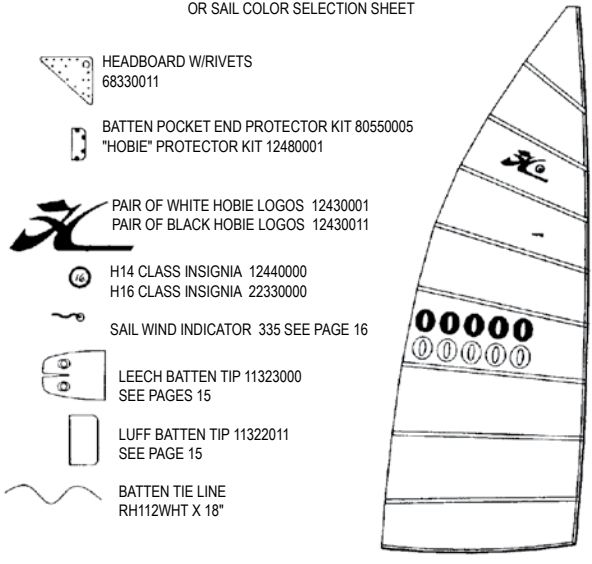

HEADBOARD W/RIVETS
68330011

BATTEN POCKET END PROTECTOR KIT 80550005
"HOBIE" PROTECTOR KIT 12480001

PAIR OF WHITE HOBIE LOGOS 12430001
PAIR OF BLACK HOBIE LOGOS 12430011

H14 CLASS INSIGNIA 12440000
H16 CLASS INSIGNIA 22330000

SAIL WIND INDICATOR 335 SEE PAGE 16

LEECH BATTEN TIP 11323000
SEE PAGES 15

LUFF BATTEN TIP 11322011
SEE PAGE 15

BATTEN TIE LINE
RH112WHT X 18"

CLEW/TACK PLATE SET
12240000

SAIL BAG/COVER 21310000

SAIL NUMBERS

	BLACK	WHITE
#0	12700030	12700000
#1	12710030	12710000
#2	12720030	12720000
#3	12730030	12730000
#4	12740030	12740000
#5	12750030	12750000
#6 & #9	12760030	12760000
#7	12770030	12770000
#8	12780030	12780000

MAINSAIL BATTEN LENGTHS

H16 BATTEN	H14 BATTEN
#8 41"	#6 42 11/16"
#7 59 1/8"	#5 60 7/16"
#6 72 1/8"	#4 74 1/16"
#5 82 3/8"	#3 84 13/16"
#4 90 3/4"	#2 93 5/16"
#3 97 3/8"	#1 107 7/8"

H16 MAIN BATTEN SET 21000001
(FOR INDIVIDUAL BATTENS SEE UNIVERSAL BATTENS ON PAGE 14)

OUTHAUL LINE RH316WHT X 74"

H14 / H16 JIB SAIL & BATTENS

H14 JIB 10992XXX SEE SEQUENTIAL PARTS LIST
H16 JIB 20992XXX SEE SEQUENTIAL PARTS LIST

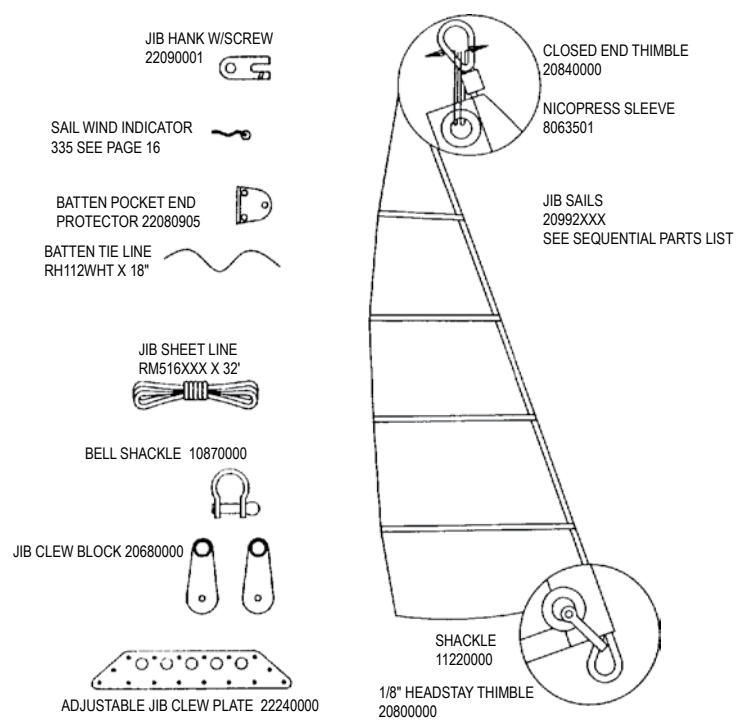

JIB HANK W/SCREW
22090001

SAIL WIND INDICATOR
335 SEE PAGE 16

BATTEN POCKET END
PROTECTOR 22080905

BATTEN TIE LINE
RH112WHT X 18"

JIB SHEET LINE
RM516XXX X 32'

BELL SHACKLE 10870000

JIB CLEW BLOCK 20680000

ADJUSTABLE JIB CLEW PLATE 22240000

JIB LEACH CAP 21333000

CLOSED END THIMBLE
20840000

NICOPRESS SLEEVE
8063501

JIB SAILS
20992XXX
SEE SEQUENTIAL PARTS LIST

SHACKLE
11220000

1/8" HEADSTAY THIMBLE
20800000

BATTEN #4 30"
BATTEN #3 43 3/4"
BATTEN #2 57 7/8"
BATTEN #1 67"

H16 JIB BATTEN SET 20400001
FOR INDIVIDUAL BATTENS SEE
UNIVERSAL BATTENS ON PAGE 14

H14 / H16 BOOM

H14 BOOM ASSEMBLY BLACK 10720011
H16 BOOM ASSEMBLY BLACK 20720011

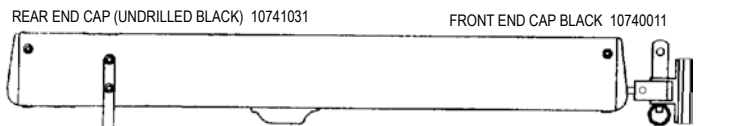

REAR END CAP (UNDRILLED BLACK) 10741031

FRONT END CAP BLACK 10740011

BLOCK HANGER
10760000

BLACK PLASTIC BARREL CLEAT 10262000
STAINLESS V-JAM CLEAT 10261000

GOOSENECK ASSEMBLY
10770001

ADJUSTER RING
10860001

CLEVIS PIN 8020421
NEWER - BOLT 8040001

CLEVIS PIN 8020061

SHACKLE 10772020

"E" CLIP 8062521
FOR BOOM PIN
THAT IS GROOVED.
(OLD STYLE)

NUT 8050121

VERTEX
50772031

SLIDE 10772001

"BOOM PIN W/HOLE
(W/ROLL PIN) 10772010
ROLL PIN 50502201
FOR BOOM PIN
THAT HAS A HOLE.
(CURRENT STYLE)

BOLT
8040021

DOWNHAUL RING 10772070

COTTER PIN 8060101
NEWER - NUT 8050101

DOWNHAUL LINE RH316WHT X 5'

H14 / H16 BLOCK SETS

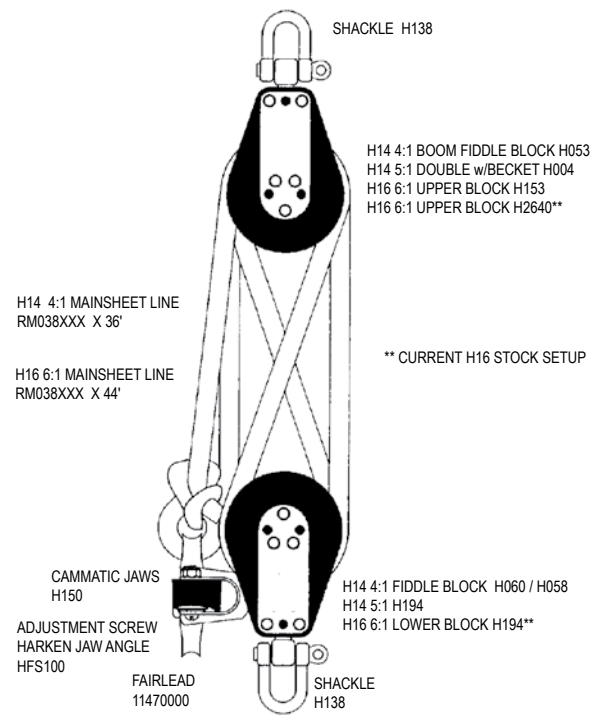

SHACKLE H138

H14 4:1 BOOM FIDDLE BLOCK H053
H14 5:1 DOUBLE w/BECKET H004
H16 6:1 UPPER BLOCK H153
H16 6:1 UPPER BLOCK H2640**

H14 4:1 MAINSHEET LINE
RM038XXX X 36'

H16 6:1 MAINSHEET LINE
RM038XXX X 44'

** CURRENT H16 STOCK SETUP

CAMMATIC JAWS
H150

H14 4:1 FIDDLE BLOCK H060 / H058
H14 5:1 H194
H16 6:1 LOWER BLOCK H194**

ADJUSTMENT SCREW
HARKEN JAW ANGLE
HFS100

FAIRLEAD
11470000

SHACKLE
H138

HOBIE 17 / 17 SPORT

REPLACEMENT HULL WHITE - LEFT 50101001
 REPLACEMENT HULL WHITE - RIGHT 50102001

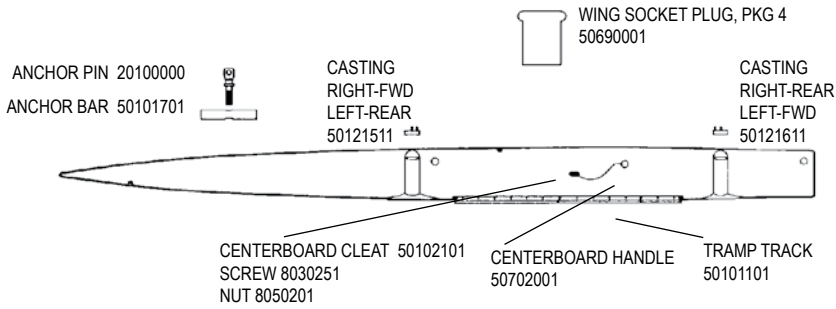

H17 HULL/DECK

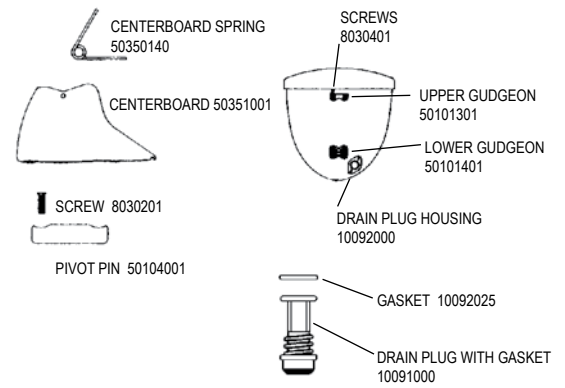

H17 FRONT CROSSBAR

BLACK 50220000

EXTRUSION ONLY
 BLACK 50221001

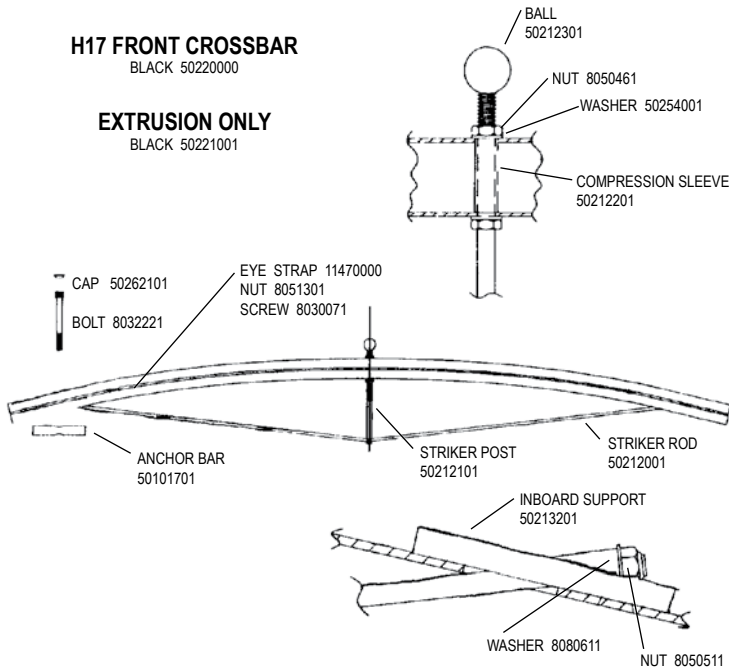

H17 TRAMPOLINE

COMPLETE TRAMPOLINES (Does not include lace line)
 5067XXXX
 (XXXX = Color / See parts list for available options)

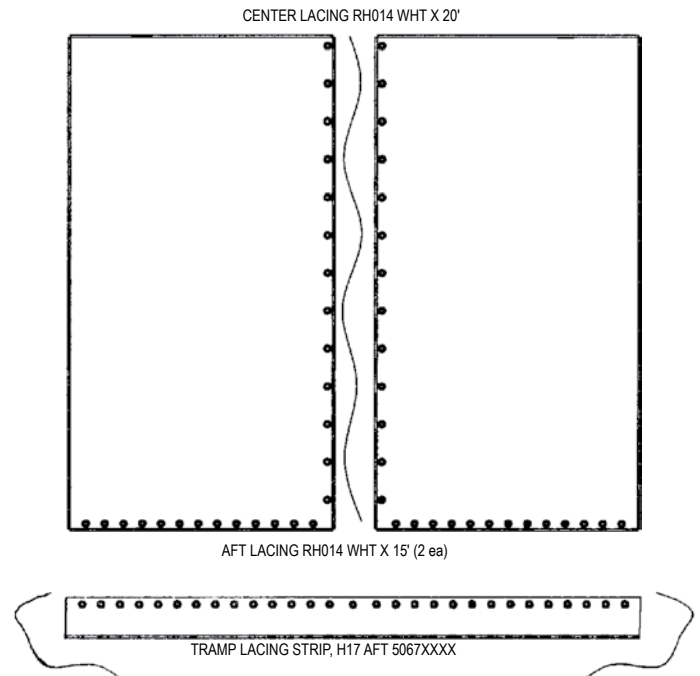

H17 REAR CROSSBAR ASSEMBLY

BLACK 50260000

CAP 50262101

BOLT 8032221

EXTRUSION
 BLACK 50261001

NOTE: ALL HOBIE 17 MODELS SINCE 1995
 HAVE A DEEP PROFILE TRAVELER TRACK THAT
 ACCEPTS THE 106 OR 112 TRAVELER CAR

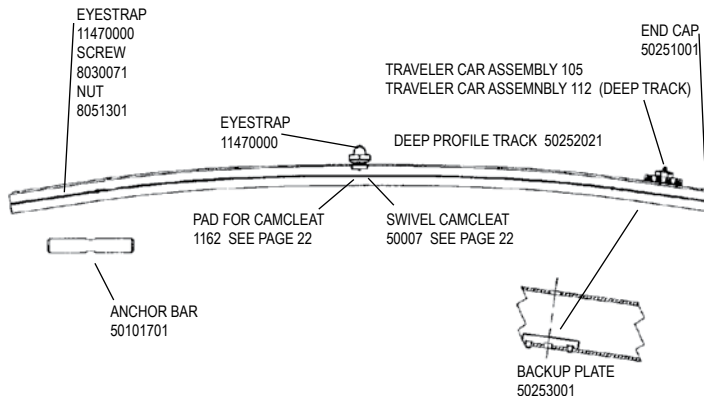

To order from your nearest Hobie Cat dealer
 U.S.A. hobiecat.com 1-800-HOBIE-49
 Australasia hobiecat.com.au 1-800-4-Hobie

H17 RUDDER ASSEMBLY

* = SUB ASSEMBLY PART / INCLUDED WITH CASTING

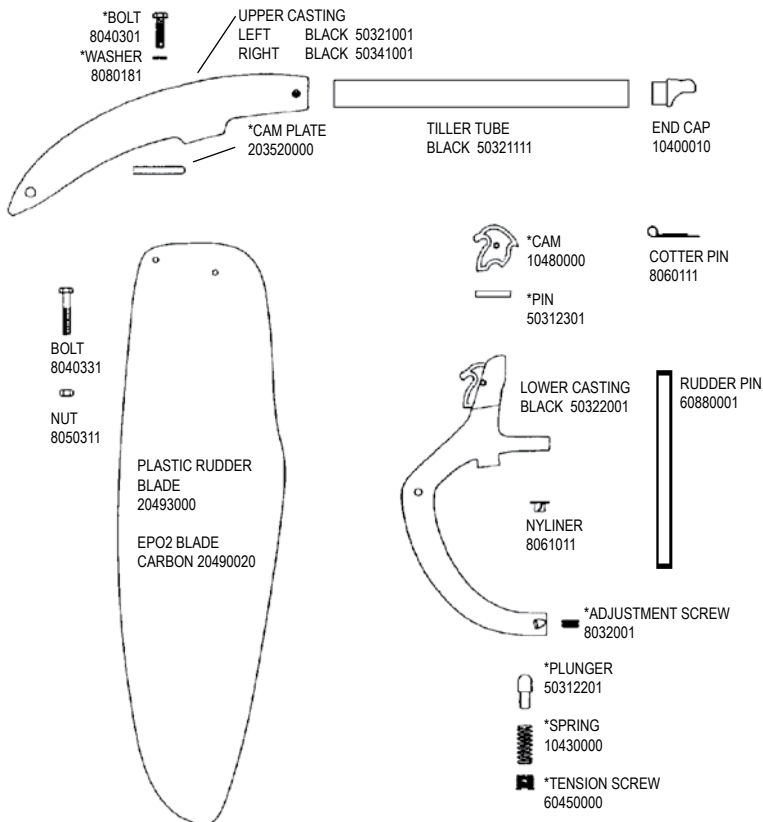

H17 TILLER

TILLER CONNECTOR KIT 11520005

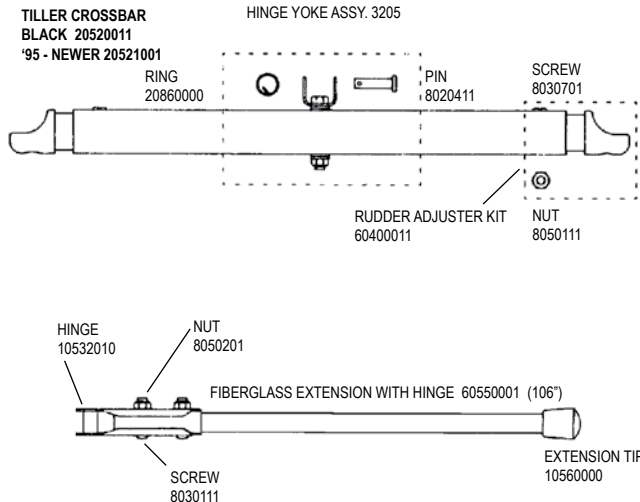
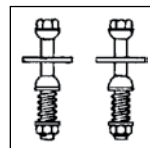

H17 MAST

MAST ASSY. BLACK 51410000
COMPTIP ASSY. 50611101

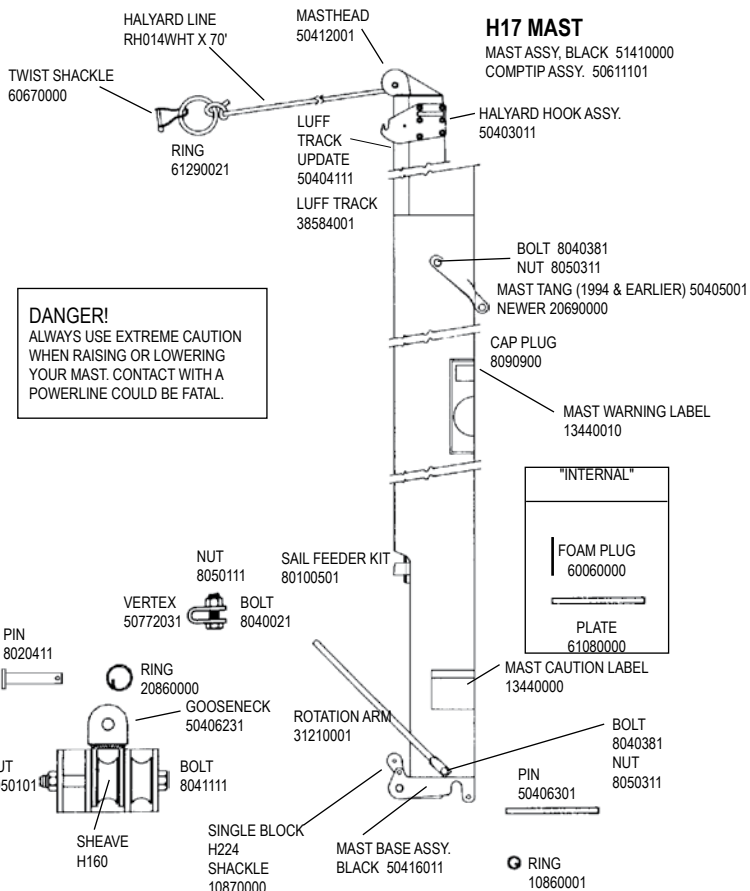

DANGER!
ALWAYS USE EXTREME CAUTION WHEN RAISING OR LOWERING YOUR MAST. CONTACT WITH A POWERLINE COULD BE FATAL.

H17 WIRES

(See page 55 for 17 Sport-Specific Wires)

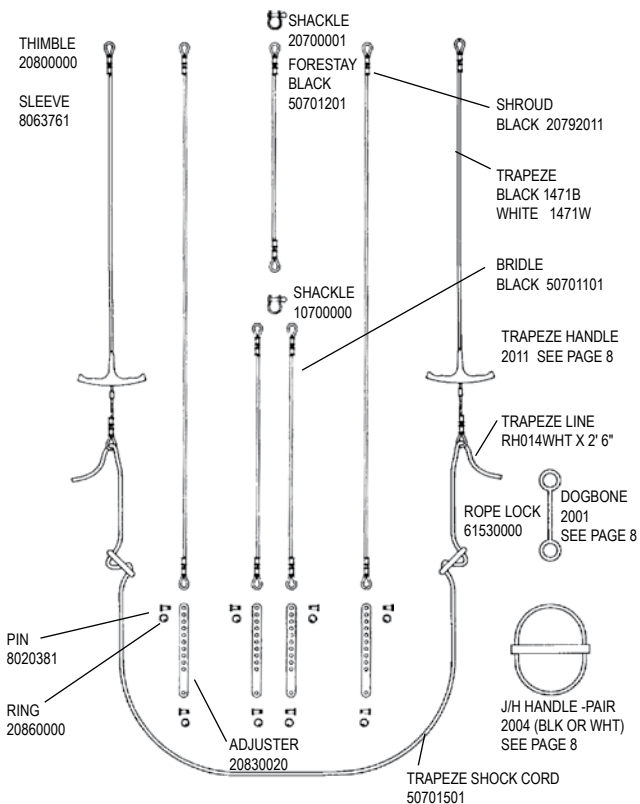

H17 SAIL

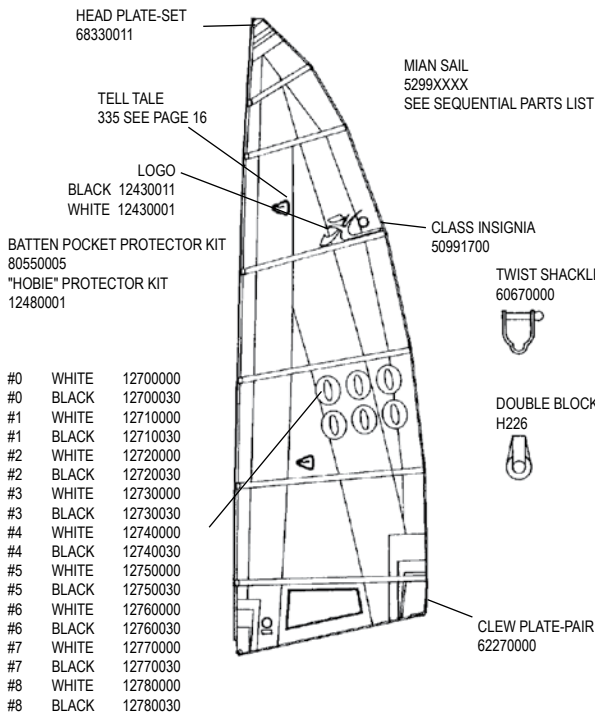

DOWNHAUL LINE
RH316WHT X 5'

SAIL BAG
21310000

BATTEN TIE
RH112WHT X 18"

H17 BLOCK SET

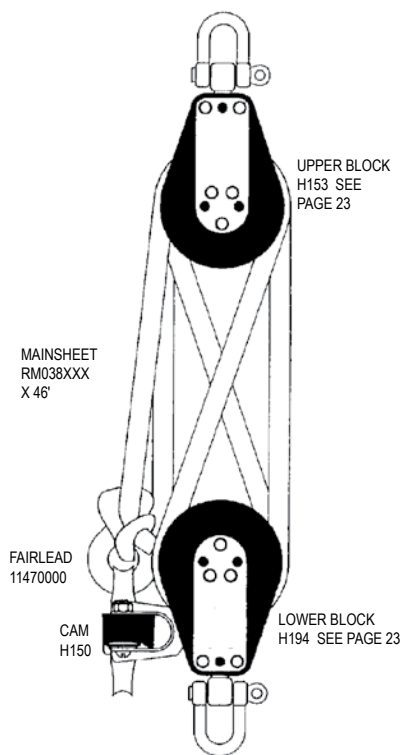

H17 Rivet Guide

() indicates quantity needed to fasten part

Mast	
Head	8010131 (2)
Halyard Hook	8011231 (3)
Base	8010131 (2)
Rear Crossbar	
Swivel Jammer	8010201 (1)
	8031501 (2)
	8031231 (2)
	8080011 (1)
	8050801 (1)
Dead Eye	8010181 (4)
Back Up Plate	8010201 (4)
Track	8010201 (44)
Hull	
Trampoline Track	8010121 (9)
(backup washers required on above, 61360000)	
Boom	
End Cap (gooseneck)	8010131 (2)
Block Hanger	8010181 (4)
End Cap	8010131 (2)
Rudder (Upper Casting)	
Casting	8011231 (4)
End Cap	8010131 (2)
Sail Hardware	
Headboard	8010020 (16)
Main Clew Plate	8010020 (10)
Batten Pocket	8010020 (4)
Jib Clew Plate	8010020 (6)
(above rivets require setting machine which is not available in a hand tool)	
Wing	
End Cap	8010051 (1)
Castings	8010131 (8)
Forward Cross Bar - Sport	
Swivel Cam Cleats	8010131 (4)

H17 / 17 SPORT BATTENS

(FOR INDIVIDUAL BATTENS SEE UNIVERSAL BATTENS ON PAGE 14)

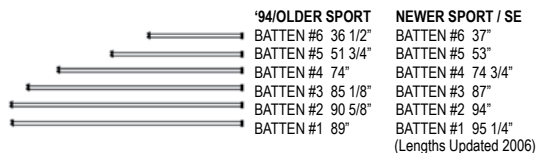

H17 WINGS

SET W/O TRAMPOLINES
50650000



WING TRAMP SET
5065XXXX
(XXXX = Color / See parts list for available options)

H17 BOOM

BLACK 50510000

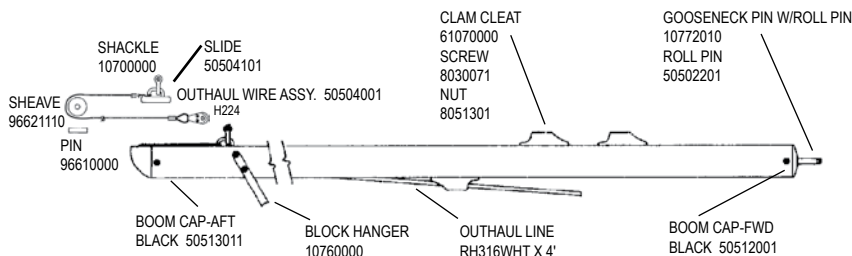

RIGHT-WING ASSY.
50680001

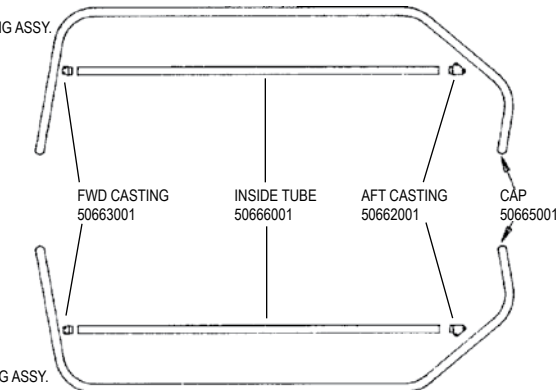

HOBIE 17 SPORT SPECIFIC

NOTE: WHERE A SPECIFIC ITEM IS NOT IDENTIFIED, USE THE STANDARD HOBIE 17 LINE DRAWINGS.

H17 SPORT FORESTAY

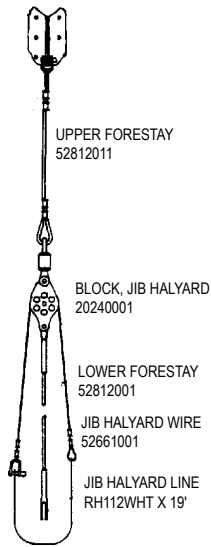

SPORT BOOMLET ASSEMBLY (NEWER, 95 - CURRENT) 52722011

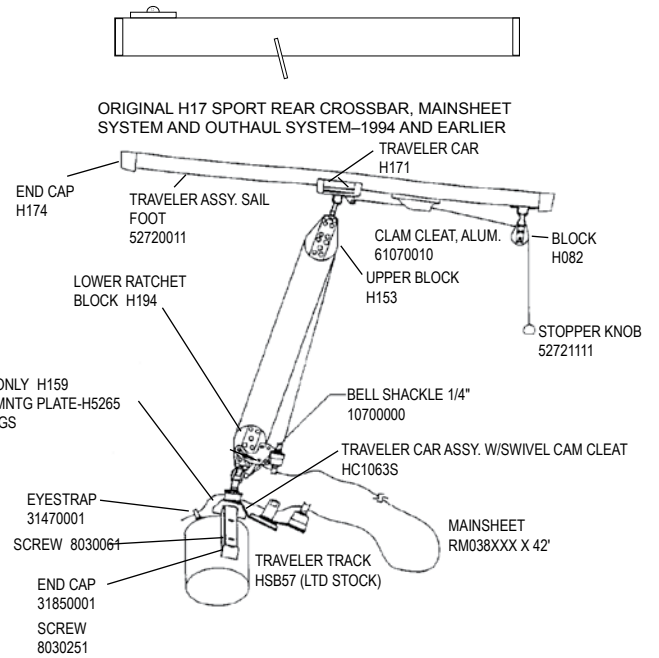

H17 SPORT SPREADER POLE & FURLER

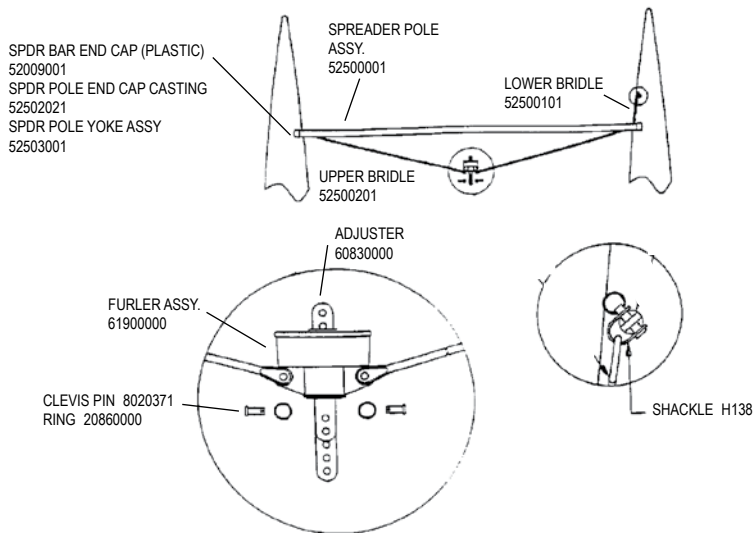

H17 SPORT MAST ASSY. & DOWNHAUL

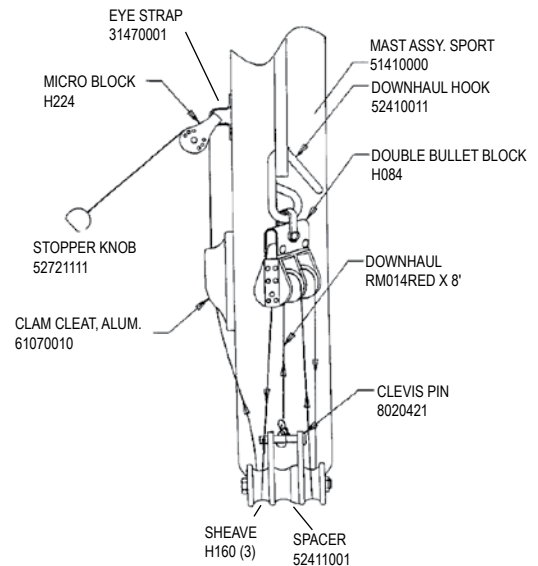

H17 SPORT FRONT CROSSBAR

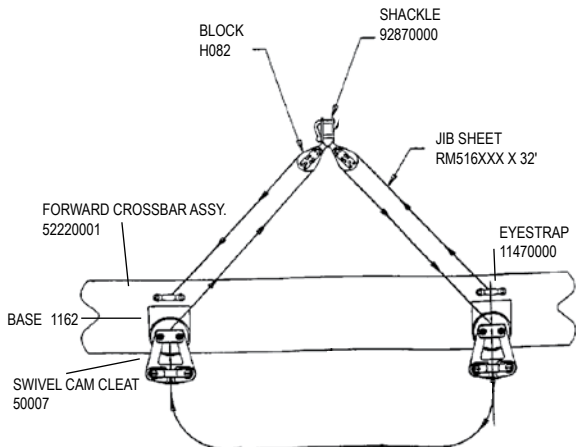

To order from your nearest Hobie Cat dealer
U.S.A. hobiecat.com 1-800-HOBIE-49
Australasia hobiecat.com.au 1-800-4-Hobie

HOBIE 18 / 18 SX

H18 HULL/DECK

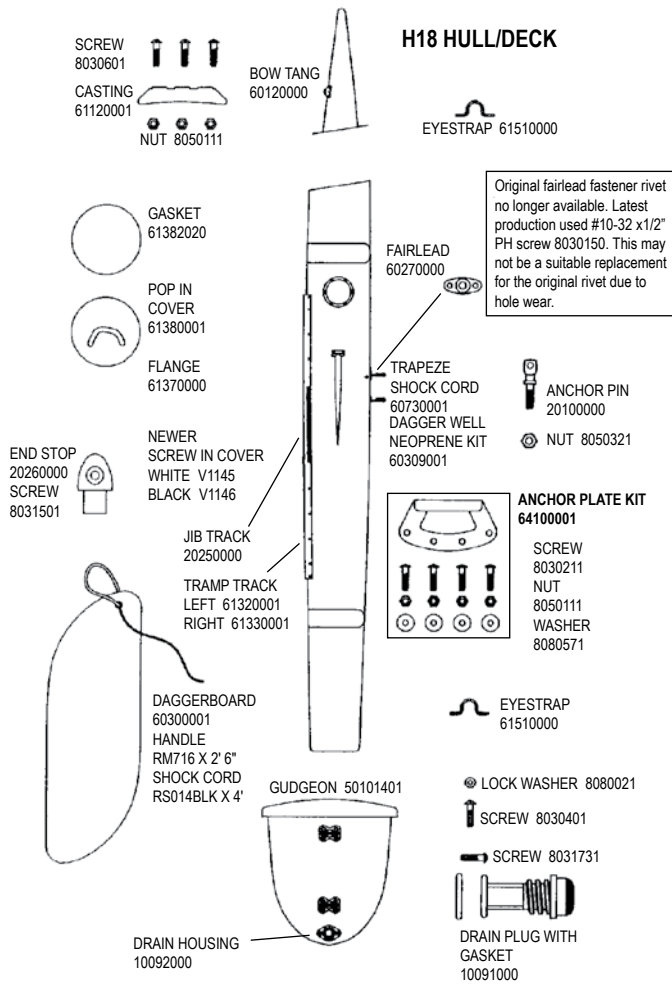

H18 TRAMPOLINE

COMPLETE TRAMPOLINE 6097XXXX
(XXXX = Color / See parts list for available options)
(Does not include lace line)

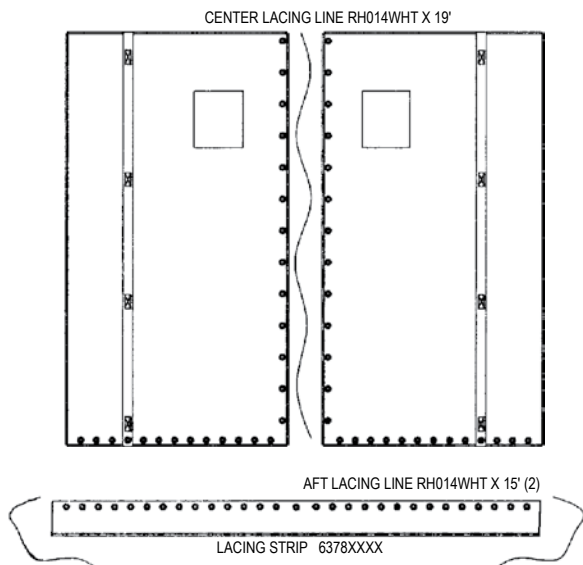

H18 FWD CROSSBAR CROSSBAR WITH STEP CASTING BLACK 60132010

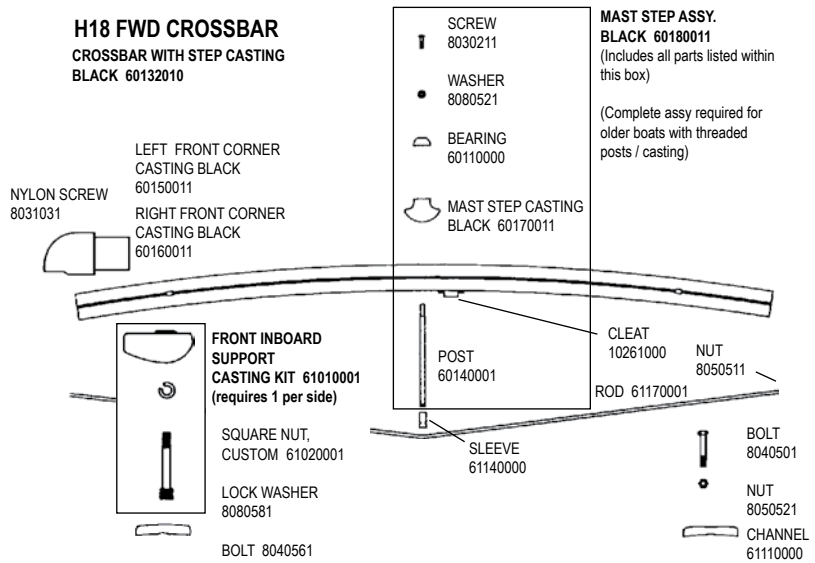

H18 REAR CROSSBAR REAR CROSSBAR - EXTRUSION ONLY BLACK 60191211

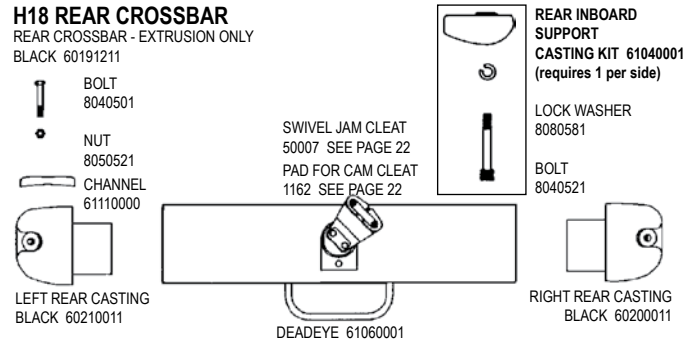

H18 MAIN TRAVELER CAR

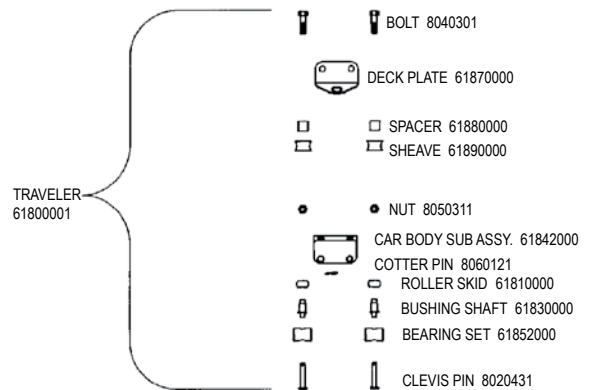

H18 / H18SX FORESTAY & JIB HALYARD

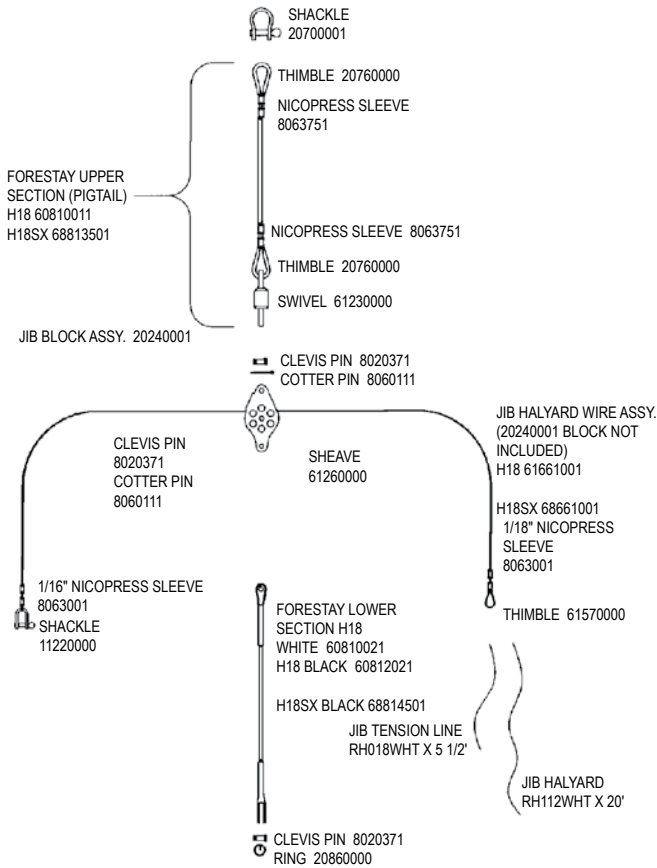

H18 / H18SX SHROUDS & ADJUSTERS

H18 SHROUD (1 SIDE)
WHITE 60790001
BLACK 60792001

H18SX SHROUD (1 SIDE) SHACKLE 20700001
BLACK 68793501

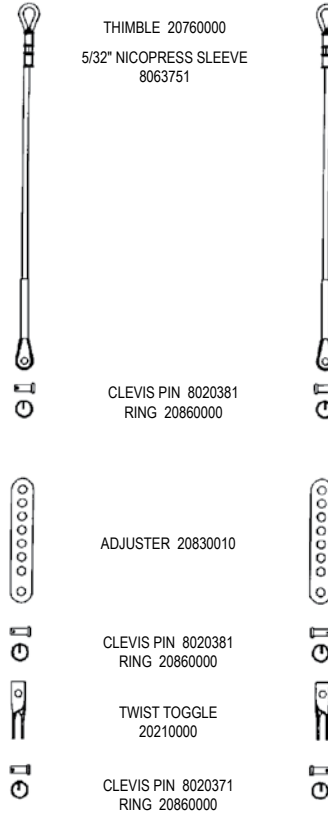

H18 RIVET GUIDE

() Indicates quantity needed to fasten part.

MAST	
HEAD	8010131 (2)
HALYARD HOOK	8011231 (6)
TANG	8010181 (12)
DIAMOND TANG	8010181 (3)
SPREADER TANG	8010181 (8)
COMPRESSION PLATE	8010181 (4)
GOOSENECK PLATE	8010181 (4)
GOOSENECK CLEAR	8010131 (2)
GOOSENECK BLOCK	8010131 (2)
BASE	8010131 (2)

(Note: all 8010181 mast rivets require 08011291 rivet caps)

REAR CROSSBAR	
CORNER CASTING	8011231 (6)
INBOARD SUPPORT	8010131 (2)
SWIVEL JAMMER	8010201 (1)
	8031501 (2)
	8031231 (1)
	8080011 (1)
	8050801 (1)
DEAD EYE	8010181 (4)

HULL	
TRAMPOLINE TRACK	8010121 (9)
(backup washers required on above, 8080551)	
ACCESS PORT FLANGE	8010141 (12)
EYE STRAP	8010131 (2)

BOOM	
END CAP	8010131 (2)

FRONT CROSSBAR	
MAST STEP	8010131 (4)
INBOARD SUPPORT	8010131 (2)
JAM CLEAT	8010181 (2)

RUDDER (UPPER CASTING)	
CASTING	8011231 (3)
END CAP	8010131 (2)

SAIL HARDWARE	
HEADBOARD	8010020 (16)
MAIN CLEW PLATE	8010020 (10)
BATTEN POCKET	8010020 (4)
JIB CLEW PLATE	8010020 (6)
(above rivets requires setting machine which is not available in a hand tool.)	

H18 / H18SX ROLLER FURLER

FURLER TUNE UP KIT 61900900
INCLUDES: BEARINGS, BEARING CAGE, NYLINER, NYLON SLEEVE, DARBY RINGS, SPOOL, HOUSING

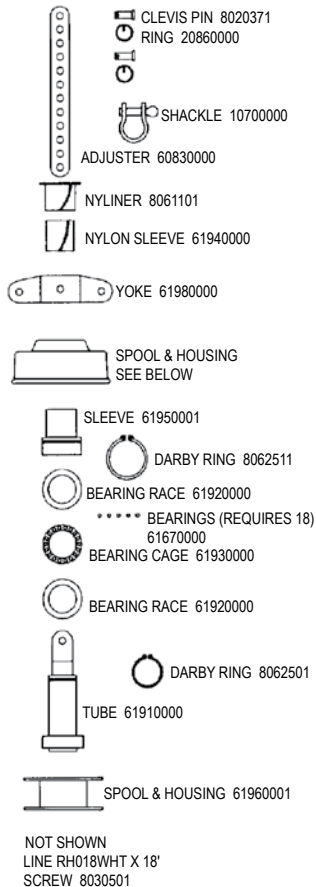

FURLER ASSY. 61900000

H18 / H18SX BRIDLES

CLEVIS PIN 8020371
RING 20860000

BRIDLE
WHITE 60820001
BLACK 60822001

CLEVIS PIN 8020371
RING 20860000

H18 / H18SX TRAPEZE WIRES

H18 WHITE 1473W (One Side Pair)
H18 BLACK 1473B (One Side Pair)

H18SX BLACK 68503501 (Single)

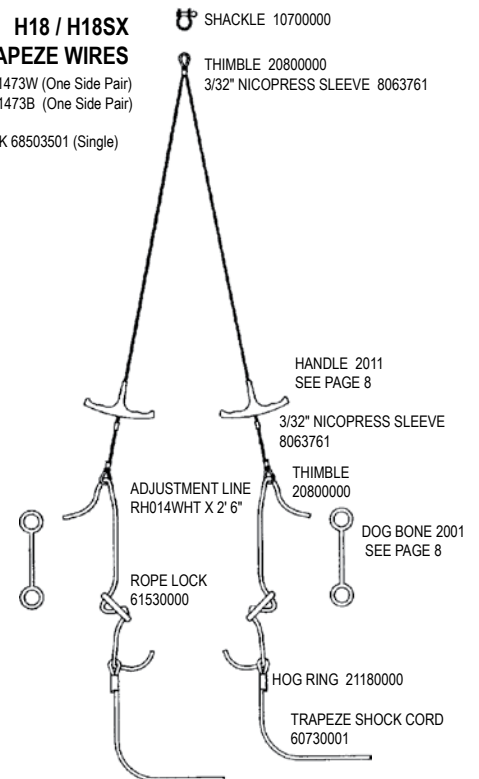

H18 MAIN SAIL & BATTENS

H18 60991XXX / H18SX 68991XXX
SEE NUMERICAL SECTION

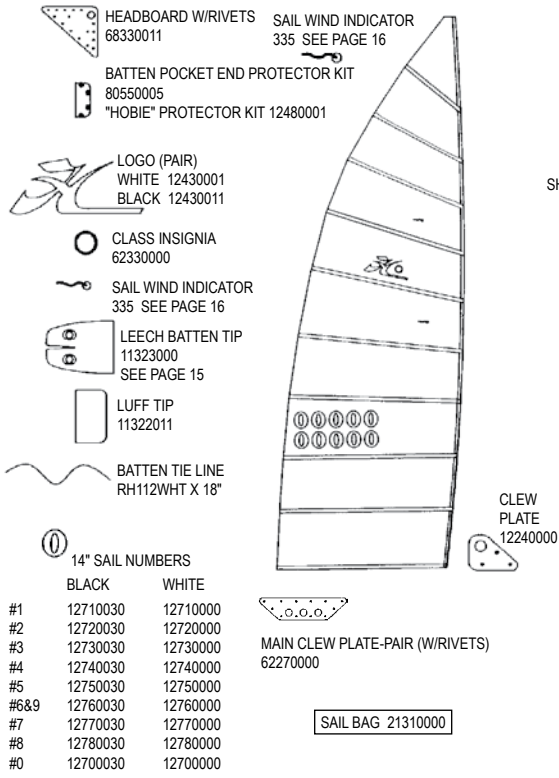

14" SAIL NUMBERS

	BLACK	WHITE
#1	12710030	12710000
#2	12720030	12720000
#3	12730030	12730000
#4	12740030	12740000
#5	12750030	12750000
#6&9	12760030	12760000
#7	12770030	12770000
#8	12780030	12780000
#0	12700030	12700000

JIB SAIL

H18 60992XXX
H18SX 68992XXX

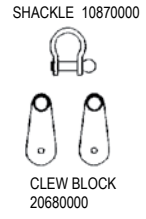
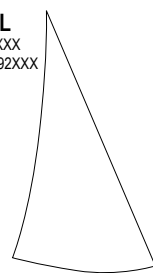

To order from your nearest Hobie Cat dealer
U.S.A. hobiecat.com 1-800-HOBIE-49
Australasia hobiecat.com.au 1-800-4-Hobie

HOBIE 18	HOBIE 18SX
BATTEN #10 24 1/8"	BATTEN #9 28 1/2"
BATTEN #9 39 1/16"	BATTEN #8 46 1/8"
BATTEN #8 56 5/16"	BATTEN #7 67 7/8"
BATTEN #7 68 13/16"	BATTEN #6 83 5/16"
BATTEN #6 79 5/16"	BATTEN #5 93 7/8"
BATTEN #5 87 5/16"	BATTEN #4 100 9/16"
BATTEN #4 93 7/8"	BATTEN #3 103 3/4"
BATTEN #3 97 5/16"	BATTEN #2 104 11/16"
BATTEN #2 101 5/16"	BATTEN #1 102 11/16"
BATTEN #1 101 5/16"	

(FOR INDIVIDUAL BATTENS SEE UNIVERSAL BATTENS ON PAGE 14)

H18 / H18SX BOOM

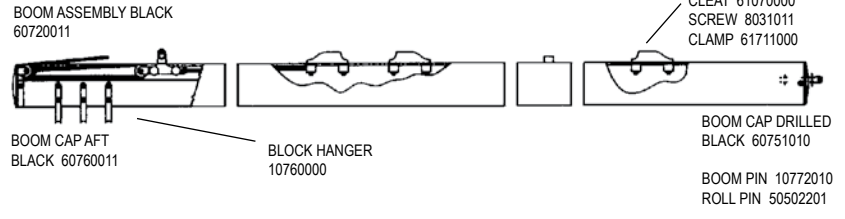

OUTHAUL CAR ASSY 60220001 (OUTHAUL AND SHOCK CORD NOT INCLUDED)

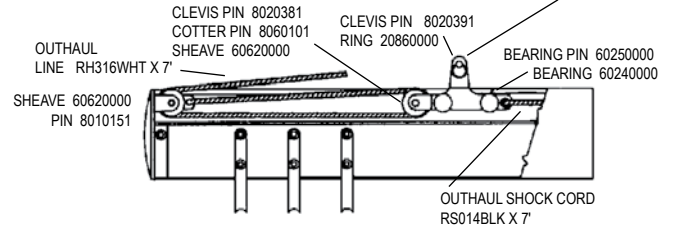

SX18 WINGS

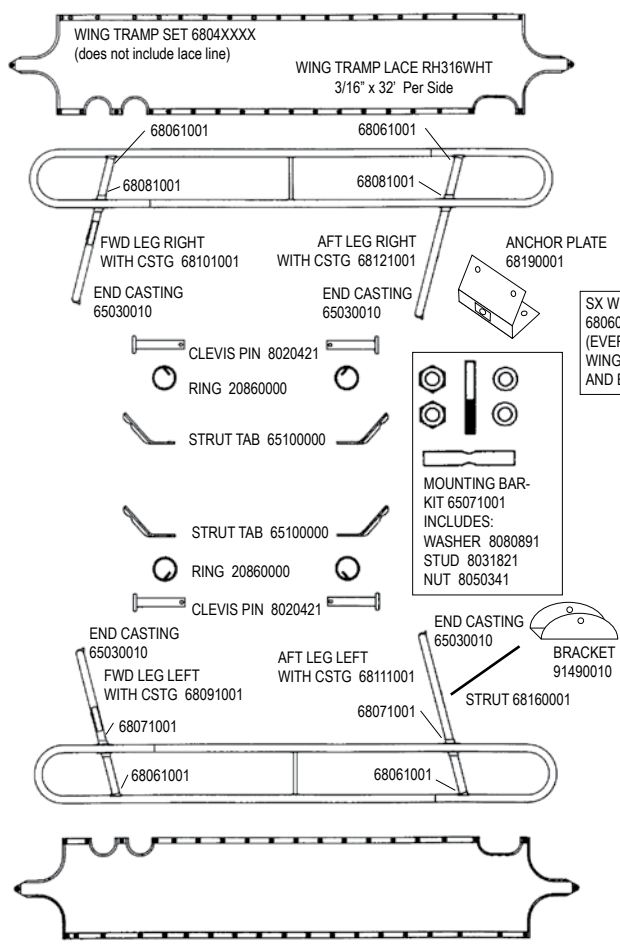

SX WINGS PARTS KIT 68060101 (EVERYTHING EXCEPT WINGS, TRAMPS, LINES AND EXTENSION)

H18 BLOCK SET WITH LINE

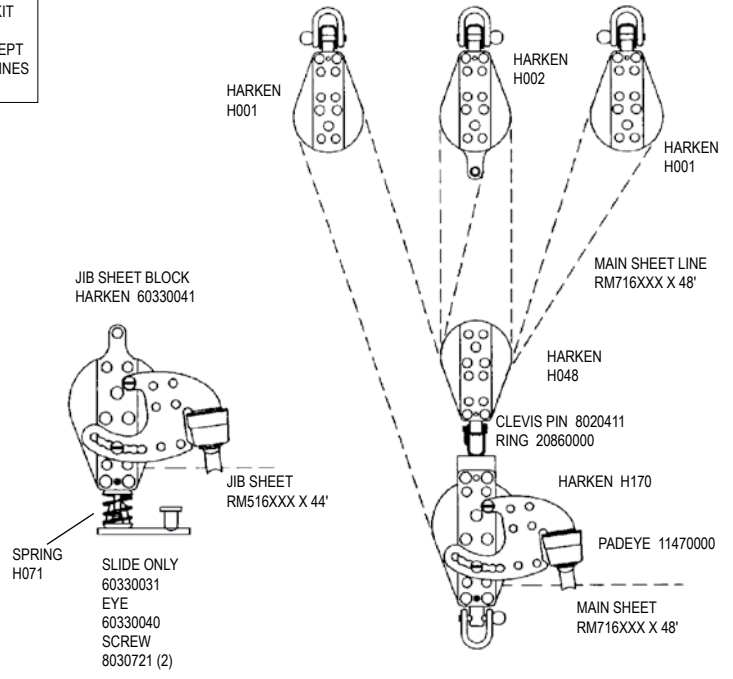

HOBIE 20

H20 REPLACEMENT HULL-PORT-WHITE 40010000
 H20 REPLACEMENT HULL-STBD-WHITE 40020000

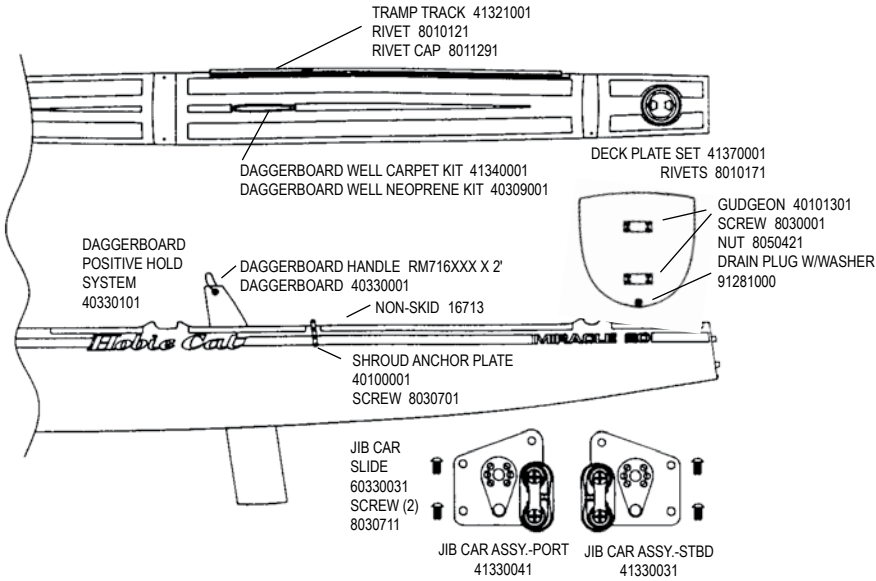

H20 MIRACLE TRAMPOLINE

(Does not include lace line or hiking straps)

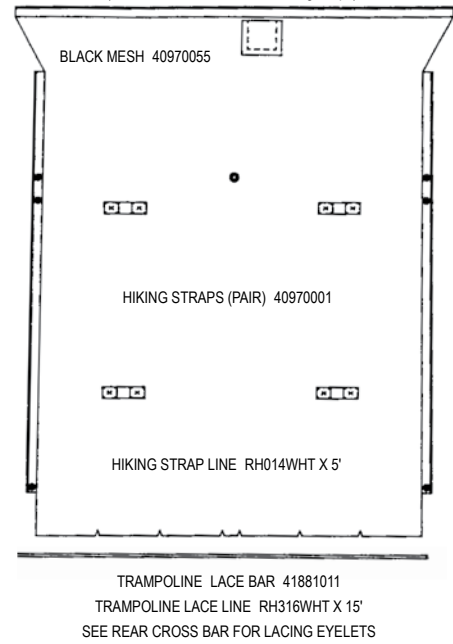

H20 MIRACLE FRONT CROSSBAR

FWD EXTRUSION 40131031

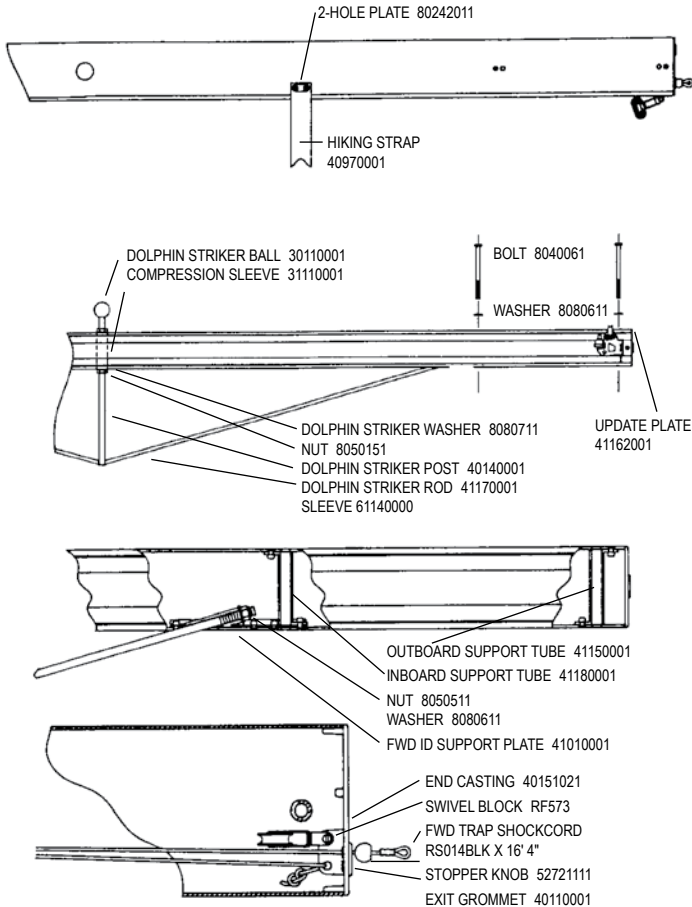

H20 MIRACLE REAR CROSSBAR

REAR EXTRUSION 40191031

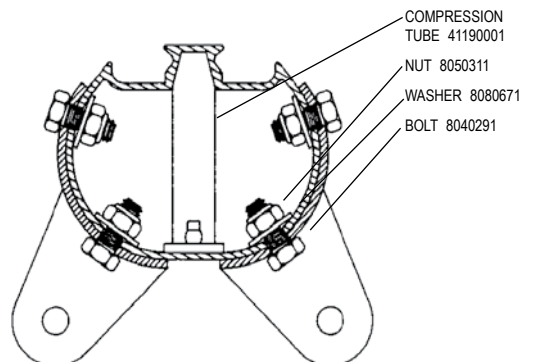
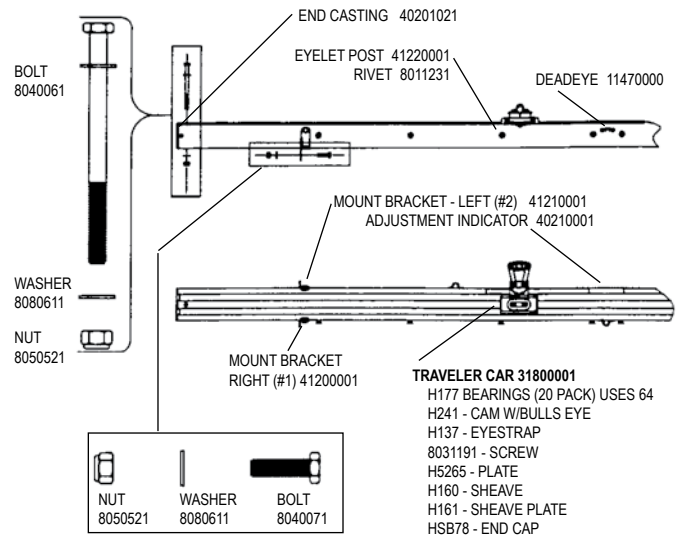

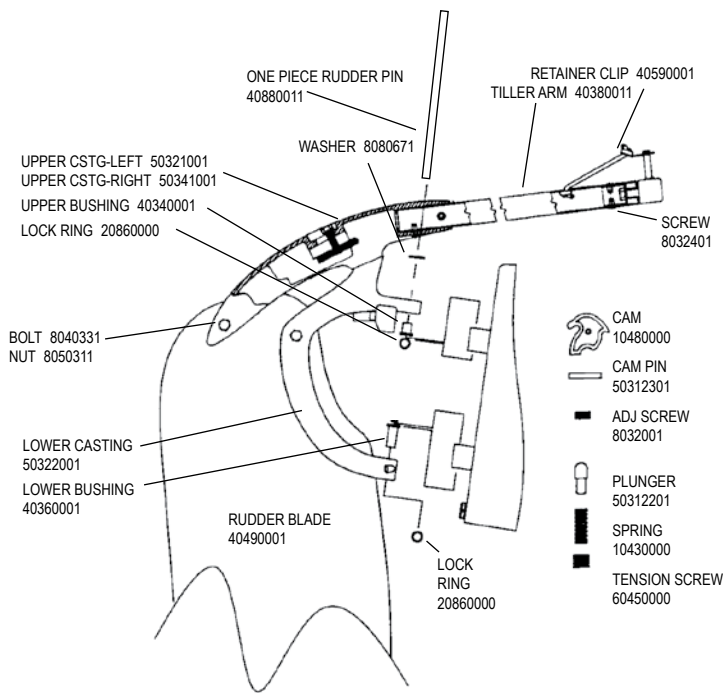

H2O MIRACLE RUDDER

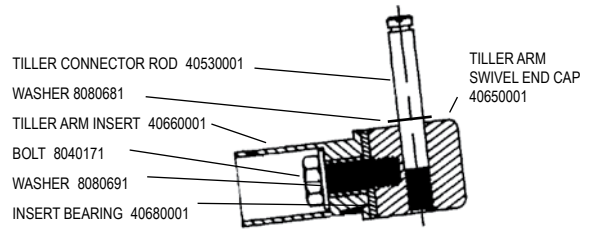

H2O MIRACLE MAST

MAST ASSY. 40581000
 COMPTIP 40401210

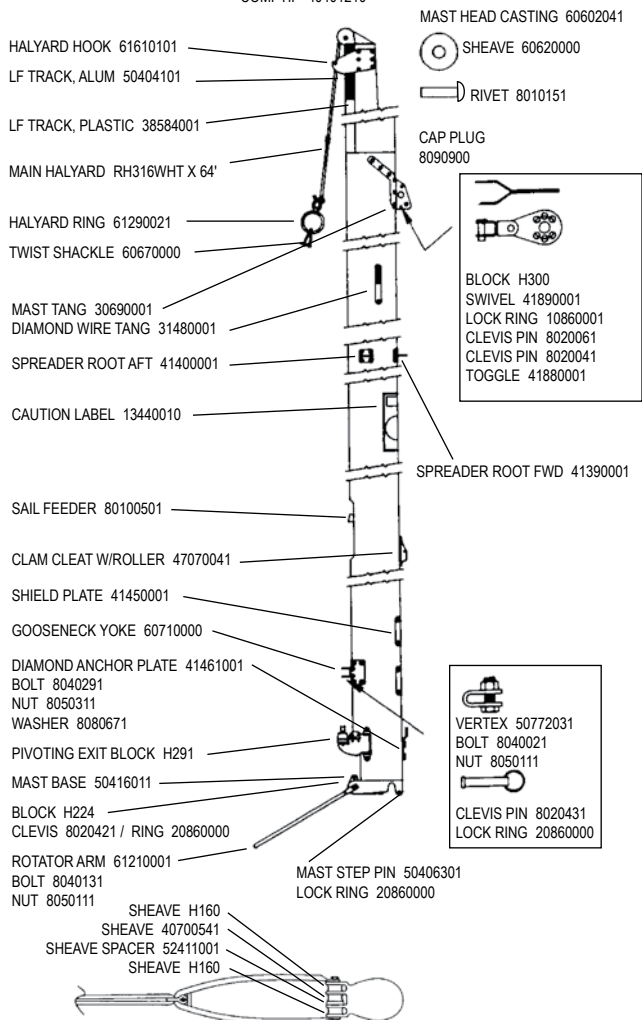

H2O MIRACLE TILLER CROSSBAR AND EXTENSION

TILLER CROSSBAR-COMLETE 40521001
 TILLER CONNECTER KIT 1953

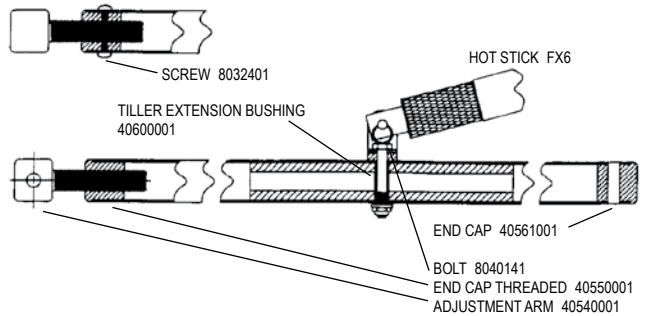

H2O MIRACLE SPREADER & DIAMOND WIRE SYSTEM

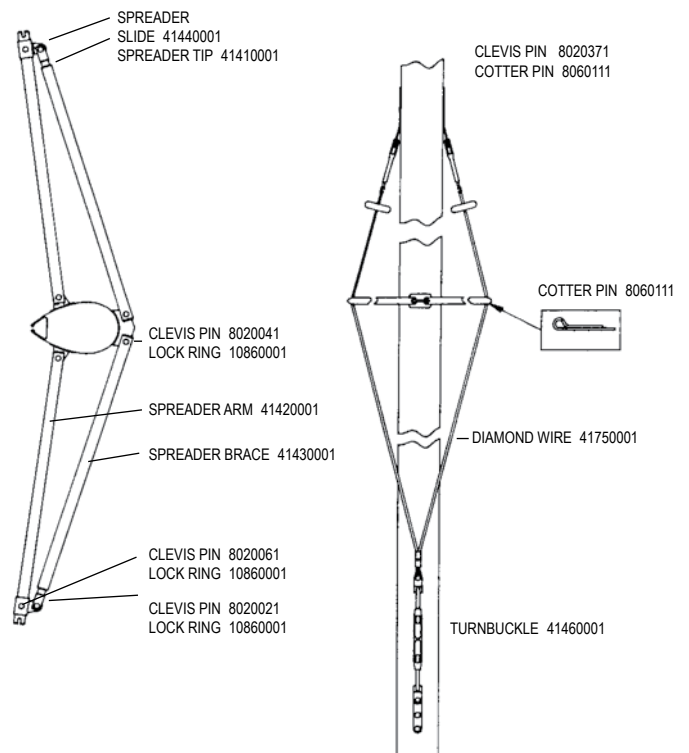

H2O MIRACLE FORESTAY AND JIB HALYARD

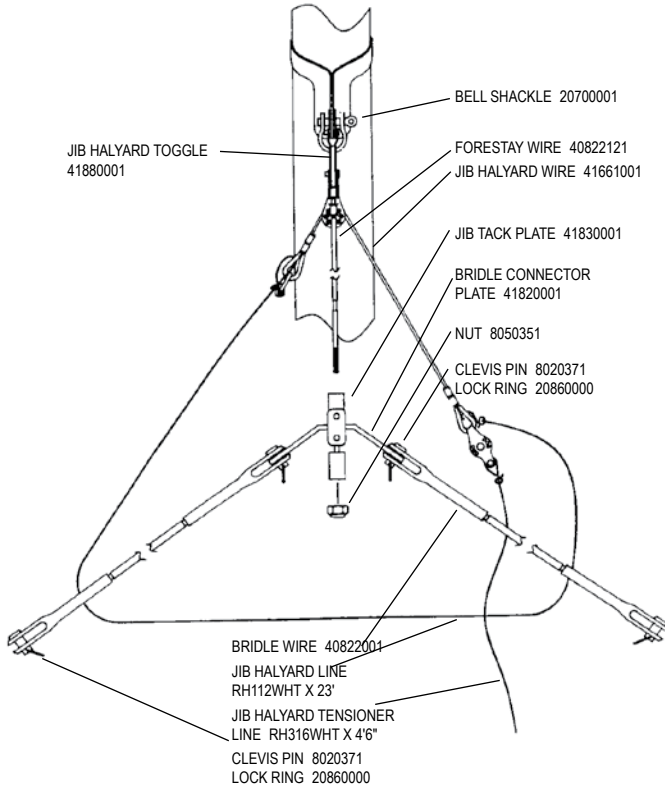

H2O MIRACLE SHROUDS AND TRAPEZE

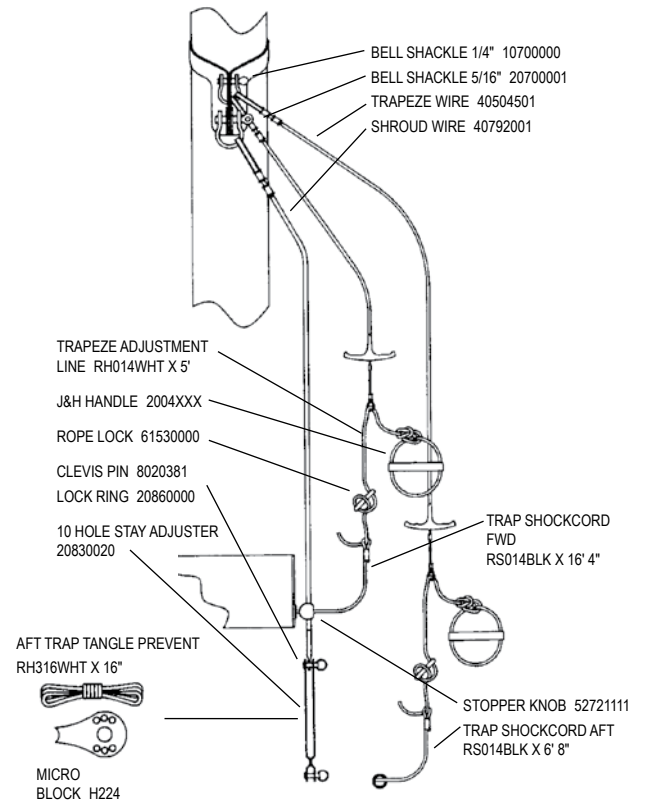

H2O MIRACLE JIB FURLING KIT

COMPLETE FURLING KIT 48921001

* = (Shown as replacement part, Not included in kit)

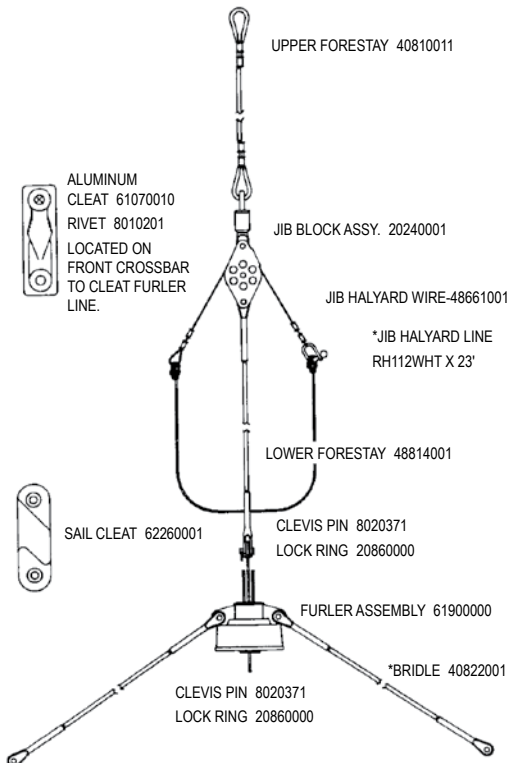

H2O MIRACLE MAST ROTATION CONTROLS

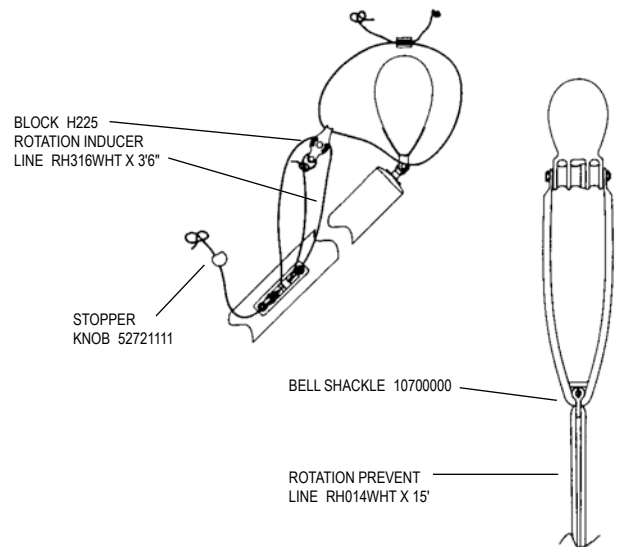

H2O MIRACLE MAIN SAIL AND BATTENS

MAIN SAIL 40991XXX

BATTEN TIE LINE
RH112WHT X 18"

HEADBOARD (ea.) 32331001
RIVETS (ea.) 8010071

BATTEN POCKET END PROTECTOR KIT
80550005
"HOBIE" PROTECTOR KIT 12480001

12430011 LOGO (PAIR)

CLASS INSIGNIA 42330001
SAIL WIND INDICATOR SET 335

14" SAIL NUMBERS

BLACK
#1 12710030
#2 12720030
#3 12730030
#4 12740030
#5 12750030
#6/9 12760030
#7 12770030
#8 12780030
#0 12790030

BELL SHACKLE 10700000
QUAD BLOCK HSB39
BLOCK H082
CLEVIS PIN 8020431
LOCK RING 20860000
DOWNHAUL LINE RM014BLK 25'

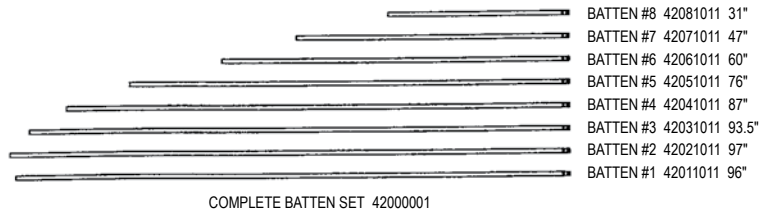
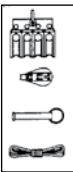
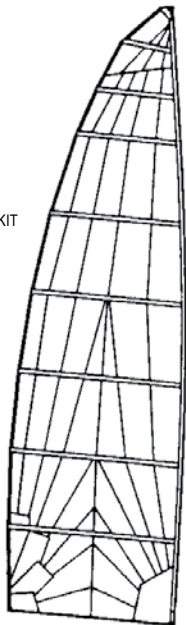

COMPLETE BATTEN SET 42000001

H2O MIRACLE BOOM

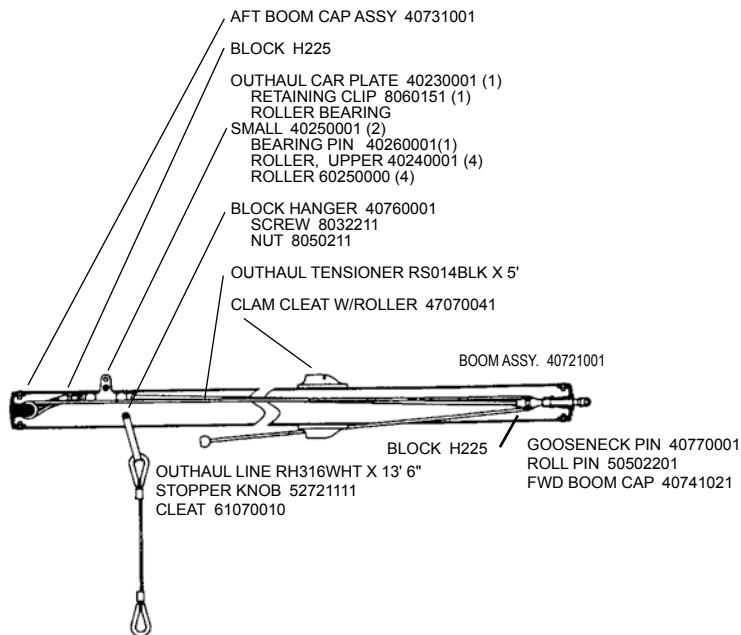

H2O MIRACLE JIB SYSTEM

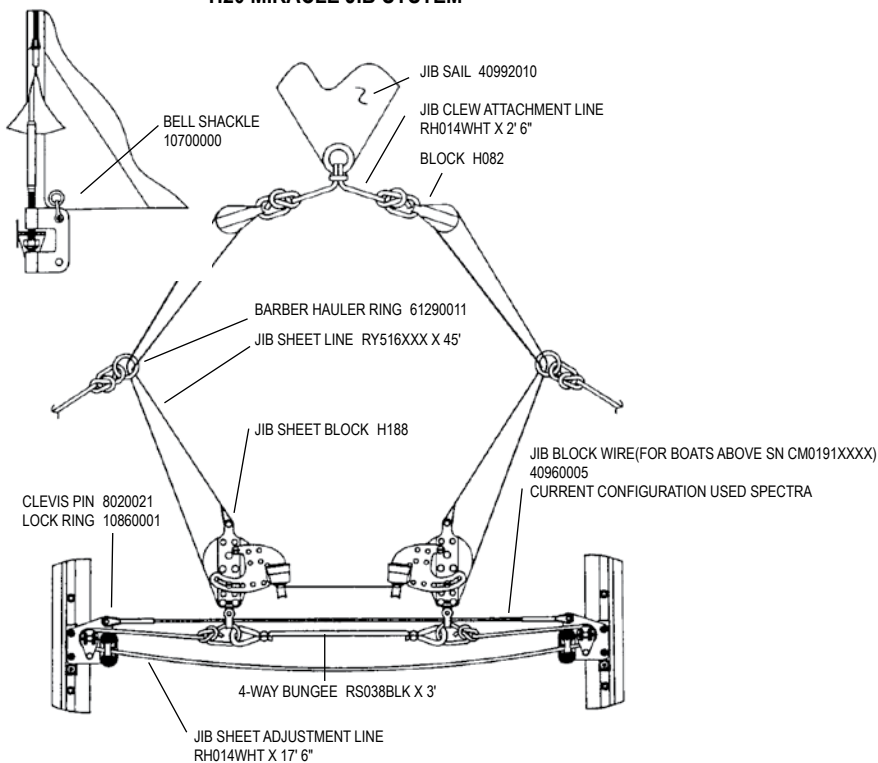

H2O MIRACLE MAINSHEET SYSTEM

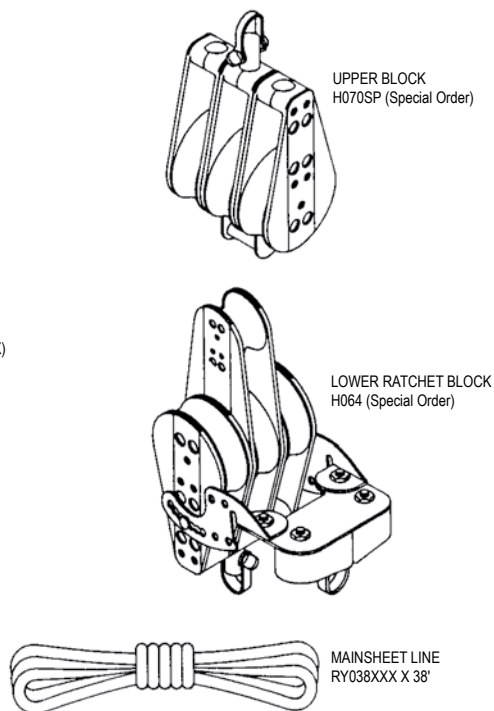

OS = Oversized item / Additional handling charges apply

Part	Description	OS	Part	Description	OS
105	TRAVELER CAR ASSY. T-2 (PRE-95		2064	TRAMP LACE KIT H14/16/18	
106	LOWER ROLLER UNIT T-1 (PRE-95		2065	TOOL, EASY RIG	
111	TRAVELER CAR ASSY BRASS		2066	TRAMP CLAMP, TRENTEC	
112	LOWER ROLLER UNIT BRASS		2067	MAIN SHEET OVRBD.PREV.66"	
114	HALYARD GRIP		2069	TOOL, EASY RIG-MAXI	
122	BATTENS-SSI SUPER JIB SET	OS	2070	CLAMCLEAT TUG CLEAT	
136	RUDDER STIFFENING KIT		2072	BOOM VANG EYE STRAP	
176	TRAP STAYS		2073	BOOM VANG 3:1 STANDARD	
204	THIRD HAND		2081	DOWNHAUL KIT H14/16	
278	Windtronic2 with Belt Pouch		2082	SCALE - DOWN HAUL / FISH	
330	WIND METER HAND HELD-MPH		2089	DOWNHAUL KIT 6:1 H14/16	
334	AIR FLOW TELS, RED		2090	HOBIE 14 "POWER PAK"	
335	AIR FLOW TELS, BLACK		2091	HOBIE 16 "POWER PAK"	
370	SHOCK CORD BALL TIES		2101	SHOCK CORD HOOK 1/4"	
374	TELO CAT, COLLAR, SET SCREW		2102	SHOCK CORD FASTENER (SCH) 5/16	
376	SILICON RTV 100% 3 OZ.		3041	LICENSE FRAME - FLY A HOBIE	
377	TELO CAT		3042	LICENSE FRAME - ID RATHER BE	
378	TELO CAT REPLACEMENT VANE		3043	LICENSE FRAME - CHROME "HOBIE"	
607	BOOK, CATAMARAN TUNING GUIDE		3052	TILLER CONNECTOR ORIGINAL	
609	BOOK, SAILING DRILLS.		3062	SHACKLE, FAST	
610	BOOK, CATAMARAN SAILING		3064	HALYARD RING-AUSSIE	
614	BOOK, CAT RACING FOR THE 90'S		3091	PADDLE, TELESCOPING 20"-39"	
790	FIBERGLASS STAIN REMOVER		3101	TRAPEZE RIG KIT, W/DOG BN	
1071	JIB TRAV. TRIM KIT W/SW.		3102	TRAPEZE RIG KIT W/O BONES	
1073	JIB TRAV. TRIM KIT		3103	BLOCK, MINI W/AXLE	
1075	SWIVEL CAM CLEAT / CAR + CLEAT		3121	DELUXE SAIL BAG	
1076	SWIVEL CAM CLEAT / CAR		3125	COMPTIP COVER, H16/18/20	
1125	CAN HOLDER,TRAMP/WING		3127	COMPTIP COVER,HOBIE 17/21	
1130	MAST BEARING MOLDED,14/16		3128	BAG TRAMP STORAGE W/ MAP	
1132	MAST BEARING W/DISK KIT		3151	MAST STEPPER, EZ STEP	OS
1161	MOUNTING PLATE W/O HDWRE		3152	HOBIE MAST STEPPER	OS
1162	MOUNTING PLATE W/HARDWRE		3153	WINCH-HAND CRANK	
1203	TRAPEZE RIG ADJ.PAIR W/O		3155	HOBIE MAST STEPPER II	
1204	TRAPEZE RIG ADJ KIT DOUBL		3156	HOBIE MAST STEPPER III	OS
1241	FOOT STRAP-PAIR		3175	MAST CRADLE HOBIE	
1263	UPRIGHT-H-16		3180	MOTOR MOUNT - H14/WAVE/16/17	
1264	UPRIGHT, H18/20		3183	MOTOR MOUNT-WAVE	
1265	UPRIGHT-H-17/SPORT		3184	MOTOR MOUNT - GETAWAY	
1491	TAPE, ANTI-CHAFE H16/20		3201	HIKING STICK ALUM J1	
1492	TAPE, ANTI-CHAFE H14/17		3202	HIKING STICK ALUM J2	
1493	TAPE, ANTI-CHAFE H18		3203	HIKING STICK ALUM J3	
1494	TAPE-3M #8560 1" X 36 YDS		3205	HIKING STICK YOKE CONN.	
1510	SUPERGOOSE, TRENTEC		3206	BLACK FOAM GRIP .570 X 11"	
1511	GOOSENECK BEARING, TRENTEC		3207	BLACK FOAM GRIP .940" X 12"	
1512	JIB PROTECTOR KIT-TRENTEC		3208	HIKING STICK GRIP	
1513	JIB PROTECTOR KIT, H20-TRENTEC		3262	SPREADER BAR END COVER	
1521	BATTEN CAP KIT,H14 LEACH		5051	RUDDER PIN,H14/16	
1522	BATTEN CAP KIT, H16 LEACH		5052	RUDDER PIN,H17/18	
1523	BATTEN CAP KIT,H18 LEACH		5106	SILICONE SPRAY PUMP 8oz	
1528	BATTEN TENSIONER, LEACH		5201	RUDDER CAM SCREW,H14/16	
1529	BATTEN CAP, FOAM 3/4", H20, P1		5202	RUDDER CAM KIT H14/16	
1531	BATTEN CAP KIT, H16 JIB		5203	RUDDER CAM SCREWS,H17/18	
1541	DRAFT GAUGE,H14 TRENTEC		5204	RUDDER CAM KIT H17/18/20	
1542	DRAFT GAUGE,H16 TRENTEC		5401	CAT BAG 5" ORANGE	
1543	DRAFT GAUGE,H18 TRENTEC		5402	CAT BAG 4"	
1544	KICK BACK KIT, TRENTEC		5403	CAT BAG 6"	
1550	KNIFE, STD. STAINLESS RIGGING		5411	FAT BAG-5"	
1551	KNIFE, DLX STAINLESS		5412	FAT BAG 4"	
1552	JIB CARS, H16-TRENTEC-PR.		5413	FAT BAG 6"	
1553	JIB CAR H16 EUROPEAN		5421	HATCH BAG KIT KAYAK	
1555	KNIFE, YACHTSMAN POCKET		7003	MIRAZYME 8 oz ODOR ELIMINATOR	
1561	LUFF CAP KIT H14 TRENTEC		7005	HOBIE BOAT CLEANER - 16oz	
1562	LUFF CAP KIT H16 TRENTEC		7006	HOBIE UV PROTECTANT - 16oz	
1563	LUFF CAP KIT H18 TRENTEC		7904	VELCRO ONE WRAP 1" BLACK	
1566	BATTEN CAP H16 JIB LUFF		8001	ROLLER FURLER KIT,H16	
1601	GELCOAT REPAIR KIT		8002	SAIL H16 JIB REC - WHITE	
1603	MAGICA RUST REMOVER GEL 8 OZ B		10049	QUICK RELEASE LEVER 1/4	
1611	POLISH, STARBRITTE MARINE		10072	MINI BLOCK	
1618	POLISH, FIBERGLASS COLOR		10075	SWV CAM CLEAT PLATE	
1619	TRAMP CLEANER,SEASPRAY		10076	DECK EYE	
1620	END CAP,CAT & TIGER TRAX		10100	BUCKLE, SIDE-RELEASE 2"	
1621	CAT TRAX W/ 8" AXLE	OS	13825	TRAPEZE HOOK 10" SPREADER	
1622	CAT TRAX W/8.5" AXLE H20	OS	14709	TRAPEZE RIG RETURN SYSTEM	
1623	CAT TRAX T-HANDLE	OS	16703	CONTACT CEMENT	
1624	CAT CRADLES, FITS H21SE/SC TIG		16706	RAIL KIT, H16 / H14 NEOPRENE	
1625	WAVE BLUE TRAX	OS	16707	NEOPRENE RACE STRIPS	
1626	BLUE TRAX W/ 8" AXLE	OS	16708	RAIL KIT,H18 NEOPRENE	
1635	CAT TRAX WHEEL ONLY REPL.	OS	16713	TAPE NON SKID(2" X 20")	
1636	BLUE TRAX WHEEL ONLY REP	OS	20301	PIN, QR 3/16 X 3/4 CUP	
1637	CAT TRAX AXLE 8 OR 8-1/2"	OS	20302	PIN, QR 1/4 X 3/4 CUP	
1640	CAT TRAX REPLA. BEARINGS		20303	PIN, QR 1/4 X 1-1/4 RING	
1641	CAT TRAX NYLON WASHERS		20304	PIN, QR 1/4 X 1 RING	
1642	CAT TRAX S.S. WASHERS		20305	PIN, QR 1/4 X 1 CUP	
1643	CAT TRAX COTTER PINS		20306	PIN, QR W/LANYD & SHACKLE	
1662	TAPE, SAIL REPAIR 2"X 25' ROLL		20307	PIN, QR 1/4 X 1-1/2 CUP	
1665	REPAIR KIT, SAIL		20310	QR WIRE KEEPER	
1791	TIE DOWN, WAVE		20311	PIN, QR 3/16 X 3/4 RING	
1793	TIEDOWN H16 CUSTOM		20312	PIN, QR 1/4 X 3/4 RING	
1794	TIEDOWN H18 CUSTOM		20313	PIN, QR 3/16 X 1/2 RING	
1795	TIE DOWN: ONE PIECE		20314	PIN, QR 1/4 X 1/2 RING	
1811	SNORKEL - H16/SPRT/18/21SC JIB		20501	HAIRPIN COTTER 5/16" 302 SS	
1812	SNORKEL - H1-14/H-14 TURBO JIB		20502	HAIRPIN COTTER 3/8" 302 SS	
1813	SNORKEL - H18SX/20/21SE JIB		20503	SAFETY PIN 1-9/16" LENGTH	
1815	SNORKEL - GETAWAY JIB		20803	TOGGLE SNAP SHACKLE 2-3/4"	
1953	TILLER CONNECTOR KIT		30101	EASY UP H14/16	
1954	TILLER CONNECTER KIT,WAVE	OS	30102	RIGHTING SYSTEM,EASY UP	
1956	CLUB TILLER CONNECTOR KIT		30105	EASY RITE H14/16/17	
1957	TILLER CONNECTION KIT '07 ROTO		30106	EASY RITE H18/21	
2001	DOG BONE, STD		30107	RIGHTING BUCKET	
2002	DOG BONE,MODIFIED		30108	EASY RITE H20	
2003	DOG BONE FLEXIBLE		30109	EASY RITE GETAWAY	
2010	TRAP HANDLE, ALUMINUM		30110	HYDROFOILS H14/16	
2011	HANDLE TRAPEZE		30112	MAST FLOAT KIT - MAMA UNIVERSA	OS
2061	GROMMET & TOOL KIT		30115	MAST FLOAT KIT W/H14/16 "BABY	
2062	GROMMETS #4 BRAS PKG. 24		30116	MAST FLOAT ATTACH H14/16	
			30118	MAST FLOAT (30113) REPL. PART	

30119	MAST FLOAT KIT "MAMA BOB" STD		8030981	SCREW 10-32 x 3/4 PHMS
30120	MOUNT KIT ONLY - MAMA UNIVERSA	OS	8030991	SCREW 10-32 X 3/4" P-FHMS
30302	CLEVIS PIN SET WAVE/GTWY		8031011	SCREW 10-24 X 1-1/4" FHMS-S SS
30303	CLEVIS PIN SET H14/16		8031031	SCREW 10-24 X 1-1/2" FHMS NYL
30304	CLEVIS PIN SET H18		8031071	SCREW 10-32 X 1-1/4 PHMS
30305	SPARE PARTS KIT H14		8031130	SCREW #10x 3/4 PHSM-PH SS(ABA
30306	SPARE PARTS KIT H16		8031151	SCREW #10 X 1/2 PHSMS-P TF-16
30307	SPARE PARTS KIT H18		8031191	SCREW 1/4-20 X 1-1/4"PHMS
30308	SPARE PARTS KIT WAVE/GTWY		8031231	SCREW 8-32 X 7/8" FHMS
30311	CONVENIENCE KIT H16		8031501	SCREW 8 X 3/4" FHMS-P SS
30312	CONVENIENCE KIT H18		8031511	SCREW 8 X 1 FHMS
30314	SPARE PARTS KIT H17		8031541	SCREW 8 X 3/4" FHMS-P SS
30315	CONVENIENCE KIT H17		8031731	SCREW 8 X 1 PHSMS-P SS
30317	CLEVIS PIN SET H17/20		8031821	SCREW 5/16-24 X 2 SKT SET *
30320	SPARE PARTS KIT H20		8031891	SCREW #14 X 3/4 P.PHMS
50007	CAM CLEAT SW W/BULLSEYE		8031950	SCREW #10 X 5/8 FHMS-P SS
50009	SWIVEL CLEAT/H150/BUL EYE		8032001	SCREW 3/8-16 X 3/4 DELRIN
50010	ADPTR PLATE W/HDWR FOR		8032011	SCREW 1/4-20x1/2 RHMS-P SS
50012	ROLLER FAIRLEAD KIT		8032051	SCREW 1/4-20 X 1-1/4 RHMS
50013	CAM CLEAT W/ROLLER		8032061	SCREW 1/4-20x1 1/4 PHMS
50014	TRAVELER TAMER KIT		8032091	SCREW 3/8-16 x1/2 NYLON PHMS-S
50015	TRAVELER TAMER II W/O CLT		8032211	SCREW 10-32 X 2-1/2 PHMS
50017	SWIVEL CAM CLEAT		8032221	SCREW 5/16-18x2-1/2 SOC-HD CAP
72010	KEY FLOAT/SCUPPER PLUG-ODYSSEY		8032401	SCREW 10-24x1/4 PHMS-P SS
72040	QUICK STRAP RACK W/TIE DN		8040001	BOLT 1/4-20x1 1/2
72041	MULTI STRAP SYSTEM		8040011	BOLT 1/4-20 X 1-3/4 HX HD SS
72042	TIE DOWN STRAPS - 12 FOOT		8040021	BOLT 1/4-20 X 7/8 HX HD SS
72043	TIE DOWN STRAPS - 15 FOOT		8040051	BOLT 1/4-20 X 3" HEX HD SS
72045	RACK PADS -24.0"		8040061	BOLT 3/8-16 X 5"
72046	RACK PADS -36.0"		8040081	BOLT, 5/16-18 X 3/4"
80038	COOLER, KAYAK GOLD		8040111	BOLT 1/4-20 X 5 HEXCAP
80039	COOLER, KAYAK BLUE		8040131	BOLT 1/4-20 X 3 1/2
83101	TOOL,HOBIE		8040171	BOLT 5/16-18 X 1 HEX HD SS
83102	TOOL GERBER MULTI-PLIER 600		8040211	BOLT 5/16-18 X 4-1/2 HHCS SS
83103	TOOL ALL PURPOSE		8040291	BOLT, 5/16-18 X 3/4
83104	TOOL, HOG RING PLIERS		8040301	BOLT 5/16-18 X 1-1/4 SS
83105	TOOL, CABLE CUTTER		8040321	BOLT 5/16-18 x 2-1/2" HX HD
83106	TOOL, SWAGE-IT		8040331	BOLT 5/16-18 X 2" HX HD
8000341	LOCTITE BLUE .5 ML CAPSULE		8040341	BOLT 5/16-18 X 2-3/8 HEX SS
8000432	MAST GLUE KIT- BOND CTIP TO MA		8040361	BOLT 3/8-16 X 3-1/2" HX HD
8001821	HIKING STRAP, TRAMPS (PER YD)		8040371	BOLT 5/16-18 X 3 7/16
8001850	WEBBING 2" BLACK		8040381	BOLT 5/16-18 X 3-3/4
8003500	GELCOAT 1/2 PT-WHITE		8040391	BOLT 5/16-18 x 2-3/4" HX HD
8004301	LINE 3/16" POLYPRO-BLUE		8040501	BOLT 3/8-16 X 2"
8004321	LINE 3/16" SGL BRAID-BLACK		8040521	BOLT 3/8-16 X 2-1/2 SCK H
8004631	LINE 5/16" DINGHY LIGHT		8040561	BOLT 3/8-16 X 3-3/4 SOCHD
8004651	LINE 1/4" DINGHY LIGHT		8040731	BOLT 1/2-13 X 3-5/8" SS*
8004951	LINE JIB HLYD AMSTEELBLUE (TM)		8041111	BOLT 1/4-20x2-3/4 HX HD MS-SS
8005611	GELCOAT QUART-WHITE		8050101	NUT 1/4-20 NYLOCK LOPRO
8006610	GELCOAT PUTTY-WHITE 1.25 OZ.		8050111	NUT 1/4-20 HX NYLOCK
8010020	RIVET 1/8 X 5/16, BRASS		8050121	NUT 1/4-20 CNTRLOCK SS
8010071	RIVET 3/16x 5/16 ALUM		8050151	NUT H21 JAM
8010121	RIVET 6-10 PN HD		8050201	NUT 10-32 STANDARD
8010131	RIVET 6-6 PN HD		8050211	NUT 10-32 NYLOCK LOPRO
8010151	RIVET, MASTHEAD SHEAVE SINGLE		8050300	NUT 5/16-18 HEX THIN JAM
8010171	RIVET 3/16 x 5/8 CSK ALUM		8050301	NUT 5/16-18 NYLON
8010181	RIVET 6-4 PN HD		8050311	NUT 5/16-18 NYLOCK STD
8010201	RIVET 3/16 X 3/8" CSK		8050331	NUT 5/16-18 HX NYLOCK LP
8010261	RIVET 3/16 x 3/16 SS		8050341	NUT 5/16-24 NYLOCK LOPRO
8011101	RIVET SEMI 3/16 x 9/16 ALUM		8050421	NUT #12-24 NYLOCK,HEX
8011231	RIVET 6-8 PN HD		8050461	NUT 9/16-18 HX JAM LP SS
8011251	RIVET 6-16 PH HD-ALUM		8050511	NUT 3/8-24 NYLOCK HEAVY
8011281	RIVET 1/4 X 1 RH SOLID-302 SS		8050521	NUT 3/8-16 NYLOCK
8011291	RIVET CAP		8050540	NUT 3/8-16 HX NYLOCK-LP
8012062	RIVET SEMI 3/16x27/32 SS		8050601	NUT 1/2-13 NYLON HEX FIN
8020021	CLEVIS PIN 3/16x.453 GRIP		8050611	NUT 1/2-20 NYLOCK LOPRO
8020041	CLEVIS PIN 3/16x.570 GRIP		8050621	NUT, 1/4-28 HEX NYLOCK
8020051	CLEVIS PIN 3/16x.709 GRIP		8050631	NUT 1/2-13 NYLOCK LO-PRO SS
8020061	CLEVIS PIN 3/16x.753 GRIP		8050801	NUT 8-32 MACH/SCREW SS
8020101	CLEVIS PIN 5/16 x 2.032 GRIP		8051301	NUT 10-32 SQUARE SS
8020181	QUICK PIN 1/4"X1-1/2"		8060001	COTTER PIN 1/16 x 1/2 SS
8020351	CLEVIS PIN 1/4x.3285 GRIP		8060101	COTTER PIN 3/32 X 1/2 SS
8020361	CLEVIS PIN 1/4x.675 GRIP		8060111	COTTER PIN 3/32 X 3/4 SS
8020371	CLEVIS PIN 1/4x.469 GRIP		8060121	COTTER PIN 3/32 X 2 SS
8020381	CLEVIS PIN 1/4x.578 GRIP		8060151	RETAINING CLIP, "E" TYPE
8020391	CLEVIS PIN 1/4x.8285 GRIP		8061001	NYLINER 1/4
8020411	CLEVIS PIN 1/4x1.0785 GRIP		8061011	NYLINER 3/8 D X 3/8 L
8020421	CLEVIS PIN 1/4x1.141 GRIP		8061101	NYLINER 1" ID X 1.094 LG
8020431	CLEVIS PIN 1/4x1.328 GRIP		8062001	BUSHING,RUDDER CASTING PKG OF
8020451	DETENT RING PIN 1/4 X 2		8062501	RING, RETAINING DARBY #1400-10
8020461	DETENT RING PIN 1/4" X 1-1/8"		8062511	RING,RETAINER,DARBY 1400-143
8020501	CLEVIS PIN,1/4X3-1/2 MAST		8062521	RING,RETAINER
8020601	CLEVIS PIN 5/16 X 1 3/8		8063001	SLEEVE NICROPRESS 1/16"
8030001	SCREW 12-24 X 1" PHMS-P SS		8063251	SINGLE SHANK SWAGE BALL 1/8
8030061	SCREW 12-24 3/4" FHMS SS		8063271	SLEEVE STOP 3/32 WIRE
8030071	SCREW 10-32 X 1/2 FHMS		8063281	SLEEVE, STOP 1/8-COPPER
8030111	SCREW 10-32 X 1 PHMS-P SS		8063501	SLEEVE NICROPRESS 1/8"
8030150	SCREW 10-32 X 1/2 PHMS-PH (ABA		8063751	SLEEVE NICROPRESS 5/32"
8030161	SCREW 10-32 X 1-1/2 RHMS-P SS		8063761	SLEEVE, NICROPRESS 3/32" *
8030201	SCREW #10x1 FHMS-P SS		8063801	SLEEVE,NICOPRESS STOP
8030211	SCREW 1/4-20 X 1" RHMS-PH SS		8080011	WASHER,STAR LOCK,8 EXT
8030241	SCREW 10-32 X 1-1/2 FHMSP		8080021	WASHER,STAR LOCK,12 INT.
8030251	SCREW 10-32 X 1" FHMS		8080051	WASHER,STAR LOCK,#6-32INT
8030281	SCREW 10-32 X 3/4" RHMS-P SS		8080101	WASHER 1/4 X 1/2" LOCK
8030291	SCREW 5/16-18 X 2" PHMS-P SS		8080151	WASHER 3/8 LOCK
8030301	SCREW 5/16-18 X 1-1/4 RHMS SS		8080181	WASHER 5/16 X 9/16 FLAT
8030311	SCREW 5/16-18x 1-1/2 RHMS		8080481	WASHER 5/16 SPRING
8030331	SCREW 1/4-20 X 3/4 PHMS-P SS		8080511	WASHER 250x.500x.063 SS
8030361	SCREW 5/16-18 X 1-1/4 SOC HD		8080521	WASHER FLAT .625x.281x.054 SS
8030380	SCREW 1/4-20 x 7/8 SOC CAP SS		8080551	WASHER-FLAT .227 X .453 SS
8030401	GUDGEON SCREW PKG OF 16		8080561	WASHER 1/4 X 1/2 X .032 SS
8030411	SCREW 12-24X3/4 LONG LOCK PHMS		8080571	WASHER FLAT 1/4x3/4x.063 SS
8030501	SCREW 8-32 X 3/8" THMS-P SS		8080581	WASHER 3/8" HC SPLIT-LOCK
8030601	SCREW 1/4-20 X 1-5/8 THMS		8080611	WASHER FLAT 3/8 X 3/4 SS
8030701	SCREW 1/4-20 X 1" THMS-P SS		8080622	WASHER 1/2" SPLIT TRIFOIL TF-2
8030711	SCREW 1/4-20 X 3/8 RHMS-P SS		8080631	WASHER 3/8 X 1 X .062 NYL TRIF

8080671	WASHER 5/16 X 3/4 FLAT SS		12440000	DECAL, SAIL H14
8080681	WASHER 5/16 X 1/2 X .030 NYLON		12450015	DECAL SET, BRAVO/WAVE CURLS
8080691	WASHER 3/8 X 3/4 NYLON-FLAT		12450016	DECAL BRAVO
8080701	WASHER 1/4 X 1 SS HP		12451031	DECAL "HOBIE" DIAMOND-TURQ/SLV
8080711	WASHER 5/8 x 1-5/16 SS		12451050	DECAL "HOBIE" SCRIPT BLACK
8080891	WASHER 11/16 X 5/16 X .065 SS		12451051	DECAL "HOBIE" SCRIPT WHT
8080901	WASHER 1/4 X 3/4 FLAT-NEOPRENE		12453031	DECAL - HOBIE CAT TEQ
8081011	WASHER 5/8 X 1" NYLON		12470001	DECAL "HOBIE" (VERT 22" LETTE
8090900	COMPTIP CAPLUG		12480000	MAIN BATTEN POCKET PROTECTOR (
10060000	PLUG, MAST & PYLON		12480001	HOBIE POCKET PROTECTOR KIT
10091000	DRAIN PLUG W/GASKET		12700030	SAIL NUMBER 14" #0 BLACK
10092000	DRAIN PLUG HOUSING		12710030	SAIL NUMBER 14" #1 BLACK
10092010	DRAIN PLUG-EACH		12720030	SAIL NUMBER 14" #2 BLACK
10092025	GASKET-BLACK RUBBER		12730030	SAIL NUMBER 14" #3 BLK.
10092100	DRAIN PLUGS-PKG 100		12740030	SAIL NUMBER 14" #4 BLK.
10092120	DRAIN PLUG GASKET-PKG/100		12750030	SAIL NUMBER 14" #5 BLK.
10131910	CROSS BAR H14 FWD BLACK	OS	12760030	SAIL NUMBER 14" #6/9 BLK.
10140000	PYLON VENT TUBE		12770030	SAIL NUMBER 14" #7 BLK.
10152011	CORNER CSTG H16 RACE L/F #1		12780030	SAIL NUMBER 14" #8 BLACK
10162011	CORNER CSTG H16 RACE R/F #2		13001001	DECAL BOW - FLYING "H" BLK
10170011	MAST STEP H14/WV BLACK		13440000	DECAL, MAST CAUTION, BLK
10191910	X-BAR H14 AFT W/O CAST BK (INT	OS	13440010	DECAL, MAST CAUTION/ORNG
10202011	CORNER CSTG H16 RACE R/R #3		13450000	ASSEMBLY MANUAL H14
10212011	CORNER CSTG H16 RACE L/R #4		13780000	TRAMP LACE STRIP H14/16 WHITE
10261000	CLEAT, STNLS V-JAMMING		13780055	TRAMP LACE STRIP H14/16 BLACK
10262000	CLEAT, BARREL		20060000	MAST FOAM PLUG - H16
10270011	SIDEBAR H14 LEFT BLACK	OS	20100000	ANCHOR PIN
10280011	SIDEBAR H14 RIGHT BLACK	OS	20120000	BOW TANG H14/16
10300000	CHAIN PLATE, "TURBO"		20132031	SHEAVE H16 JIB TRAV
10311900	RUDDER LOCKING KIT H14/16		20140001	DOLPH STRIKER POST H16/14
10352011	UPR RDR CSTG H14/16 LEFT		20170001	DOLPHIN STRIKER ROD H16
10362011	UPR RDR CSTG H14/16 RIGHT		20200011	MAST STEP,H14/16 BLACK
10382010	TILLER ARM H14 STRGHT BLK		20210000	TWIST TOGGLE
10400010	TILLER END CAP		20240001	BLOCK H16/18 JIB HALYARD
10412011	LWR RDR CSTG H14/16 BLK		20250000	TRACK - H16 JIBSHEET BLOCK
10430000	SPRING RUDDER CASTING		20260000	TRACK END CAP 5/8"
10440000	PLUNGER,RUDDER H14/16		20270011	SIDE BAR H16 BLACK
10470000	PIN RUDDER CASTING		20352000	RUDDER CAM STOP PLATE
10480000	CAM		20382011	TILLER ARM H16 STR BLACK
10520011	TILLER XBAR H14 BLACK	OS	20390001	BATTEN HINGE
10532010	TILLER EXTENTION HINGE		20392001	BATTEN HINGE KIT 4 EACH
10532020	TILLER EXTENTION YOKE		20400001	BATTEN SET H16 JIB
10560000	CAP-ROUND POLYETHYLENE, BLACK		20490020	RUDDER BLADE EPO-2 CARBON
10581100	MAST ASSY H14 BLACK		20491000	RUDDER BLADE EZ LOC w/INDENTS
10582100	COMPTIP H14	OS	20492021	EZ LOC PLUNGER - LWR RDR HOUSI
10602111	MAST HEAD,H14 COMPTIP		20493000	RUDDER BLADE - WHITE NYLON
10620000	SHEAVE,H14 MAST HEAD		20520011	TILLER XBAR H16/17/18 BLK
10640011	MAST BASE H14/WV BLACK		20521001	TILLER XBAR H16/17/18 '95
10651001	HALYARD - H14 (NON COMPTIP)		20550001	TILLER EXT H14/16 (84")
10657001	HALYARD - H14 (COMPTIP)		20610000	MAST ASSY H16 BLACK
10670000	SHACKLE, HALYARD		20611100	COMPTIP H16
10680000	HOOK, HALYARD (12 GA)		20614001	MAST HEAD H16 COMPTIP
10690000	MAST TANG H14/WV		20614210	SHEAVE 2-1/4" OD BLACK DELRIN
10700000	SHACKLE "BOW" 6.4 MM		20616001	LUFF TRACK H16 93" (SPECIAL H1
10720011	BOOM H14 BLACK	OS	20617001	HALYARD - H16 MAIN (COMPTIP)
10730000	CLEAT-MAST		20640011	MAST BASE H16 BLACK
10740011	BOOM CAP,H14/16/21SC FWD		20651011	HALYARD - H16 MAIN (NON COMPTI
10741031	BOOM CAP,H14/16 AFT BLACK		20661001	WIRE JIB HALYARD ASSY H16
10760000	BLOCK HANGER		20680000	SHEET BLOCK
10770001	GOOSENECK ASSY H-14,16		20690000	MAST TANG H16/17/18
10772001	GOOSENECK SLIDE		20700001	SHACKLE BOW 5/16 PIN
10772010	GNECK BOOM PIN (W/RL PIN)		20710000	BLOCK, H16 MAST CHEEK
10772020	GOOSENECK SHACKLE		20720011	BOOM H16 BLACK **NOT UPS
10772070	GOOSENECK DOWNHAUL RING		20730001	TRAPEZE SHOCKCORD H14T/16
10792100	WIRE SHROUD H14 BLACK		20730002	TRAP SHCKCD W/HOOK H14/16
10810010	WIRE FORESTAY H14T UPPER		20742001	WIRE H16 TRAPEZE W/ BLOCK (EA)
10812101	WIRE FORESTAY H14 BLACK		20760000	THIMBLE 5/32"
10820011	WIRE BRIDLE H14 TURBO WHT		20790011	WIRE SHROUD H16/17/SPT WHT
10822010	WIRE BRIDLE H14 TURBO BLK		20792011	WIRE SHROUD H16/17/SPT BLK
10822101	WIRE BRIDLE H14 BLACK		20800000	THIMBLE 1/8"
10860001	LOCK RING 3/16"		20800001	WIRE SET - H16 5/32" BLACK
10870000	SHACKLE "BOW" 4.7 MM		20810011	WIRE FORESTAY H16 UPR
10881000	RUDDER PIN H14, NYLON		20810021	WIRE FORESTAY H16 LWR BAR
10970000	TRAMP SET H14 WHITE		20810031	WIRE FORESTAY - H16 AUSSIE
10970055	TRAMP SET H14 BLACK MESH		20810041	WIRE FORESTAY UPPER - H16 AUS
10970058	TRAMP SET H14 TURQ MESH		20811011	WIRE FORESTAY H16 LWR WHT
10990010	SAIL H14 MAIN WHITE		20812011	WIRE FORESTAY H16 LWR BLK
10991086	SAIL H14 MAIN CORONADO '08		20820011	WIRE BRIDLE H16 WHITE
10992081	SAIL H14 JIB TURQUIOSE		20822011	WIRE BRIDLE H16 BLACK
10992511	SAIL H14 JIB WHITE		20830010	ADJUSTER 1/4" 7 HOLE - SHROUD/
11070000	BLOCK, H16 JIB HALYARD		20830020	ADJUSTER 1/4" 10 HOLE - SHROUD
11110005	MAST BEARING, PKG OF 3		20840000	SAILMAKERS THIMBLE 5/32
11110100	MAST BEARING, PKG OF 100		20860000	LARGE CLEVIS RING
11140011	TURBO STRIKER CASTING *		20860021	CLEVIS RING - WAVE SE SHROUD
11170000	DOLPHIN STRIKER-WIRE H14		20880001	RUDDER PIN ALUM - H14/16
11170030	DOLPHIN STRIKER ROD H14		20880011	RUDDER PIN S.STEEL - H14/16
11220000	SHACKLE STND "D" 4.7 MM		20970000	TRAMP SET H16 WHITE
11322011	BATTEN CAP-LUFF		20970055	TRAMP SET H16 BLACK MESH
11323000	BATTEN CAP-LEACH (2 holes)		20970057	TRAMP SET H16 BLUE MESH
11400000	BLOCK, H18 DOWNHAUL		20970058	TRAMP SET H16 TURQ MESH
11470000	DEAD EYE		20970059	TRAMP SET H16 GRAY MESH
11510000	TILLER CONN. HALF SPHERE		20991011	SAIL H16 MAIN WHITE
11520005	TILLER CONNECTOR KIT		20991085	SAIL H16 MAIN SMOKE '08
11540000	TILLER CONNECTOR,SPRING		20991086	SAIL H16 MAIN CORONADO '08
11720000	BOOK, LEARN TO SAIL-HOBIE		20991991	SAIL H16 MAIN SP.ORDER DAC
11810011	PLATE MAIN TRAV TRK RETRO		20992010	SAIL H16 JIB WHITE
11840100	TRAVELER HINGE		20992071	SAIL H16 JIB TURQUIOSE
11850000	TRAVELER.HINGE WIRE		20992081	SAIL H16 JIB SILVER
11860000	TRAVELER SPACER		20992086	SAIL H16 JIB RED '08
11870000	TRAVELER,DECK PLATE		20992991	SAIL H16 JIB SP.ORDER
11880000	TRAVELER SHEAVE		20999020	SPIN KIT H16 COMPLETE TRUMPET,
11901010	PAD FOR 240/241 SWVL BASE		21000001	BATTEN SET H16 MAIN
11952021	FAIRLEAD REPLACEMENT KIT		21090001	MAST SEAL PLATE,H16
12240000	TACK/CLEW PLATE SET		21180000	HOG RING 1/2" S/S, BLUNT, 14 G
12430001	DECAL, SAIL HOBIE "H"-WHT		21180010	HOG RING 5/8" SS,BLUNT, 14 GA
12430011	DECAL HOBIE SAIL"H" BLACK		21230000	CAR JIBSHEET W/BLOCK H16

21310000	BAG SAIL & BOOM STANDARD		37900021	BLOCK DOUBLE SWVL w/BKT GTWY	
21333000	BATTEN CAP JIB-SINGLE		37970055	TRAMP GETAWAY BLACK MESH	
21380001	MAST STEP LINK KIT H14/16		37970058	TRAMP GETAWAY TURQ MESH	
21900030	BRIDLE WIRE H16 ROLLER FUR		37971058	WING COVER GETAWAY TURQ MSH PR	
22080905	LUFF BATTEN PROTECTOR - JIB		37980055	TRAMP GETAWAY FWD BLACK MESH	
22090001	JIB HANK W/ SCREW		37991075	SAIL GETAWAY MAIN SPIRIT	
22240000	JIB CLEW PLATE (6 HOLE)		37992071	SAIL GETAWAY JIB TURQUOISE	
22330000	DECAL SAIL - H16 CLASS INSIGNI		38010061	SEAT PAD LT BLUE	
23450000	ASSEMBLY MANUAL H16		38016001	BATTEN SET WAVE	OS
25131910	X-BAR H16 FWD W/STEP	OS	38040011	BACKREST WAVE T/F	OS
25191911	X-BAR H16 AFT	OS	38041001	COVER (SUNBRELLA)-BACKREST PAD	
25231051	JIB CAR STOP H16 (INT TRACK)		38101301	PINTLE WAVE UPPER	
25232201	JIB TRAV CAR LT - BRASS WHEELS		38101401	PINTLE WAVE LOWER	
25232211	JIB TRAV CAR RT - BRASS WHEELS		38120011	EYESTRAP WAVE BRIDLE	
25243003	JIB CAR SLIDE-ONLY W/ WHEELS		38120041	TANG HW BOW SPREADER	
25244001	JIB CAR - PLATE ONLY		38131041	X-BAR WAVE CLB/SE FWD NEW STEP	OS
30101001	DOLPHIN STRIKER ADAPT,H21		38132001	CROSS BAR STOP WAVE	
30110001	MAST STEP BALL-GTWY/20/21		38140001	TRAPEZE RIGGING KIT WAVE	
30490001	RUDDER BLADE H21SE		38170001	STUD HW MAST STEP	
30601001	MAST HEAD H21		38171001	MAST STEP HW (BALL STYLE)	
30690001	TANG FOR SHROUD,H21/SC/20		38190021	END CAP AFT WAVE BLACK	
30691001	TANG FOR REACHER,H21/21SC		38191031	CROSS BAR WAVE AFT	OS
30740001	RUDDER PIN H21/SC		38321111	TILLER ARM, WAVE ORIGINAL STYL	
30791001	WIRE SHROUD H21 BLACK		38360001	BUSHING WAVE LWR PINTLE	
30811001	WIRE FORESTAY H21 UPR		38370001	HULL SEAL CAP (UNDER SEATPAD)	
30821001	WIRE BRIDLE H21 BLACK		38450000	ASSEMBLY MANUAL WAVE	
30830001	SHROUD ADJUSTOR,H21		38490011	KEEPER PIN W/LANYARD WAVE	
30840031	CLAMP H17/21/SC SHROUD EX		38581041	MAST ASSY WAVE 2-PC T/F	OS
30840041	SPACER H21/SC SHROUD EXT		38582100	COMPTIP WAVE	OS
30861001	WIRE FORESTAY H21 LWR BLK		38583141	MAST WAVE LOWER, NEWER TYPE T/	OS
30998001	SPINNER BRIDLE WIRE H21		38584001	LUFFTRACK 87"-EXCPT H16 / GTWY	OS
31210001	MAST ROTATION BAR 17/21		38641001	MAST BASE CSTG WAVE NEWER TYPE	
31370001	HATCH COVER FLANGE,H21		38650031	MAST CRADLE, WAVE AFT	
31800001	TRAVELER CAR ASSY H20/21SC		38650041	MAST CRADLE, WAVE SET	
31830001	TWIST TOGGLE H21/SC		38650200	TRAILER ALUM HOBIE BRAVO (TF)	OS
31840001	TRAVELER TRACK W/CAPS H21	OS	38651000	TRAILER ALUM HOBIE WAVE (TF)	OS
31850001	TRACK END STOP H21/17SPT		38651001	HALYARD, WAVE MAIN	
32330001	DECAL SAIL H21		38651100	MAST STAND ALUMINUM FORWARD	OS
32331001	HEADBOARD H20/21 MAIN		38651200	MAST STAND ALUMINUM REAR	OS
35041001	WING LEG H21/SC FWD		38653000	TRAILER ALUM HOBIE 16-20 (TF)	OS
35051001	WING LEG H21/SC AFT		38653100	DOUBLE ROLLER KIT - TRAILER AL	
35131001	WING STRUT KIT H21		38653200	CRADLE MOUNT KIT - TRAILER ALU	
36040001	CRANK HANDLE ASSY-21C		38660011	BACKREST COLLAR FWD WAVE	
36040011	CRANK SHAFT, SPORT CRSR		38660031	BACKREST COLLAR AFT WAVE	
36040021	BLOCK SHAFT CONN / 21SC		38670011	"S" HOOK,WAVE HALYD DWNHL	
36040031	CRANK SHAFT BEARING		38760021	TUBE SE WAVE TRAMPOLINE	
36370001	HATCH COVER ASSY H21C		38760031	TRAMP ANCHOR HOOK SE WAVE	
36370051	TRIM LOCK - HATCH 21SC		38760041	CAM CLEAT PLT-CLUB/SE	
36581051	COMPTIP H21SC	OS	38760061	HOOK WAVE SE TRAMP (OLD)	
36601000	DECAL FLYING "H" SMALL BLK		38760071	HOOK WAVE SE TRAMP (SLIDE)	
36601011	DECAL FLYING "H" SMALL WHT		38790001	WIRE SHROUD SE WAVE W/HOOKS	
36772041	GNECK BOOM PIN H21SC		38822011	WIRE BRIDLE WAVE SE W/HOOK-1/8	
36800061	KNOB, FOUR-PRONG CLAMPING		38870001	CRADLES STACKING WAVE SET 4	
36970000	TRAMP SET H21C MAIN - WHITE		38881011	TRAMP LACING BAR WAVE	OS
36980055	TRAMP H21SC FWD-BLACK MESH		38900031	"S" HOOK, WAVE MAIN SHEET	
36992001	SAIL H21C JIB WHITE	OS	38900061	BLOCK, STD FIDDLE W/BEARING	
37001000	WING SET GETAWAY T/F	OS	38900071	BLOCK, 40MM FIDDLE W/CAM, BKT,	
37016001	BATTEN SET GETAWAY	OS	38950011	END CAP WAVE JIB SPREADER	
37091001	WING TENSION LEG GETAWAY		38970000	TRAMP SET WAVE SE WHITE	
37101001	WING LEG GTWY		38970051	WIRE WAVE SE TRAMP	
37131910	X-BAR GETAWAY FWD ASSY	OS	38970055	TRAMP WAVE BLACK MESH	
37140001	TRAPEZE RIG KIT GETAWAY		38970057	TRAMP WAVE SE BLUE MESH	
37151041	END CAP FWD XBAR CSTG P/S GTWY		38970058	TRAMP WAVE SE TURQ MESH	
37170001	STUD MAST STEP GETAWAY		38970061	STRAP WAVE SE TRAMP AFT TENSIO	
37191910	X-BAR GETAWAY AFT ASSY	OS	38990050	BAG SAIL WAVE/TRIFOILER	
37201021	CSTG AFT XBAR END CAP GETAWAY		38991000	SAIL WAVE MAIN WHITE	OS
37321111	TILLER ARM GETAWAY		38991075	SAIL WAVE MAIN SPIRIT	
37341011	TRAMP TRACK MAIN GETAWAY	OS	38991076	SAIL WAVE MAIN SPIRIT W/ZIP	
37342011	TRAMP TRCK FWD GETAWAY	OS	38992007	SAIL WAVE JIB YELLOW 25sq ft	
37370021	HATCH COOLER WHT GETAWAY		38992010	SAIL WAVE JIB WHITE (25 sq ft)	
37370031	GASKET COOLER COVER MOUNT		38992071	SAIL WAVE JIB TURQUOISE (25 sq	
37380001	CLAMCLEAT MINI GETAWAY		38999000	SPIN POLE & HRDWR KIT WAVE	
37382011	TILLER ARM GETAWAY EZLOC		38999001	WAVE JIB SPDR & HRDWR KIT	OS
37450011	ASSEMBLY MANUAL GETAWAY		38999021	BOW SPREADER - WAVE	OS
37500001	BOW SPREADER GETAWAY	OS	38999052	SPINNER WAVE (60 sq ft)	
37500021	PLATE GTWY BOW SPRDR		39100011	ANCHOR PLATE CLUB WAVE SHROUD	
37500031	END CAP GTWY BOW SPRDR		39130021	END CAP FWD BLACK	
37521001	TILLER XBAR GTWY - M20/ALUM CA	OS	39250000	MAIN TRAVELER KIT - CLUB WAVE	
37522001	TILLER XBAR GTWY - TENDON/ALUM	OS	39312000	WAVE EZ LOC RUDDER ASSY - ADD	
37523001	TILLER XBAR GTWY - TENDON/EZ L	OS	39341011	TRAMP TRACK WAVE CLUB	OS
37524001	TILLER XBAR GTWY - '07/EZ LOC	OS	39382011	TILLER ARM WAVE EZ LOC	
37561001	TILLER END CAP (TENDON STYLE)		39521001	TILLER XBAR WAVE "CLUB"	OS
37561011	TENDON GTWY/WV - KIT		39522001	TILLER XBAR WAVE "TENDON"	OS
37561200	TLR END CAP, w/HOLE (UAI)		39524001	TILLER XBAR WAVE "EZ LOC"	
37561203	TLR END CAP, PIN ASSY (UAI)		39640020	MAST FLT PLT	
37583141	MAST GETAWAY LOWER T/F	OS	39790001	WIRE SHROUD WAVE CLUB	
37601001	MAST HEAD ASSY GTWY		39810001	WIRE FORESTAY WAVE CLUB	
37610000	MAST ASSY GETAWAY	OS	39822011	WIRE BRIDLE WAVE CLUB	
37611001	SHEAVE GTWY MAST HEAD		39970000	TRAMP CLUB WAVE WHITE	
37611100	COMPTIP GETAWAY	OS	39970055	TRAMP CLUB WAVE BLACK MESH	
37611151	LUFF TRK GTWY 101.5"		39970057	TRAMP CLUB WAVE BLUE MESH	
37641001	MAST BASE CSTG GETAWAY		39970058	TRAMP CLUB WAVE TURQ MESH	
37651001	HALYARD MAIN GETAWAY		39991000	SAIL WAVE MAIN RESORT WHITE	OS
37660031	WING END CAP LF/RR GTWY		40100001	SHROUD ANCHOR PLATE H20	
37660041	WING END CAP RF/LR GTWY		40101301	GUDGEON H20	
37661091	LANYARD GTWY WING LEG		40110001	EXIT GROMMET	
37760041	CAM CLEAT PLT- GTWY (BENT)		40131031	CROSSBAR H20 EXTRUS FWD	OS
37790001	WIRE SHROUD GETAWAY		40140001	DOLPHIN STRIKER POST, H20	
37810001	WIRE FORESTAY ASSY GETAWAY		40151021	END CAP H20 FWD X-BAR	
37810021	WIRE FORESTAY LWR GETAWAY		40191031	CROSSBAR H20 EXTRUS AFT	
37810030	YOKE GETAWAY FORESTAY		40201021	CROSSBAR H20 AFT END CAP	
37822011	WIRE BRIDLE GETAWAY		40210001	DECAL, TRAVELER ADJUSTMENT	
37830020	FORESTAY ADJ. 1/4" 10 HOLE GT		40230001	OUTHHAUL CAR, H20	
37880001	LACING ROD GTWY FWD 68.0"	OS	40240001	OUTHHAUL ROLLER	
37880011	LACING ROD GTWY MAIN 64-3/4"		40250001	OUTHHAUL BEARING	
37900011	BLOCK SWVL RATCHET w/ARMS GTWY		40260001	OUTHHAUL BEARING PIN	

40280001	RUDDER ROTATE PREVENT BLK		50251001	END CAP H17S TRAV TRK	
40309001	DAGGER WELL NEOPRENE KIT		50252021	TRACK H17 TRAVELER DEEP	
40330001	DAGGERBOARD, H20	OS	50253001	CROSSBAR H17 BACK UP	
40330101	DAGGERBOARD POS HOLDING SYSTEM		50254001	DOLPHIN STRIKER H17 WASHR	
40340001	RUDDER PIN BUSHING H20 UPPER		50260000	CROSSBAR H17 AFT ASSY BLK	OS
40360001	RUDDER PIN BUSHING H20 LOWER		50261001	CROSSBAR H17 AFT EXT BLK	OS
40380011	TILLER ARM H20		50262101	CROSSBAR CAP H-17 PKG OF 4	
40401210	COMPTIP H20	OS	50311031	CASTING UPPER RUDDER BRAVO	
40490001	RUDDER BLADE, H20		50312201	PLUNGER RUDDER H17/18	
40504501	WIRE TRAPEZE H20 PR.		50312301	PIN RUDDER CAM H17/18	
40521001	TILLER XBAR ASSY H20	OS	50313001	EZ LOC RDR HOUSING	
40530001	TILLER CONNECTER POST		50313201	LINKAGE EZ LOC RDR HOUSING	
40530021	TLR CONNECTER SCREW/CLUB		50313301	RIVET LWR RDR HOUSING	
40540001	TILLER CONN ADJUSTER THREADED		50314001	EZ LOC - UP-LOCK PIN KIT	
40550001	TILLER CONN END CAP - THREADED		50321001	RUDDER CASTING UPR LT BLK	
40561001	END CAP TILLER CONNECT FIXED		50321111	TILLER ARM H17 BLACK	
40581000	MAST ASSY H20	OS	50322001	RUDDER CASTING LWR BLACK	
40590001	TILLER CONNECTOR RETAINER		50341001	RUDDER CASTING UPR RT BLK	
40600001	TILLER EXTENSION BUSHING		50350140	CENTERBOARD SPRING H17	
40650001	END CAP TILLER ARM SWIVEL		50351001	CENTERBOARD H17	
40660001	TILLER ARM INSERT		50403011	HALYARD HOOK H17	
40680001	TILLER CONNECTOR		50404101	LUFF TRACK UPDATE (12.5")	
40700541	DOWNHAUL SHEAVE H20		50404111	LUFF TRACK UPDATE (14.8") H17	
40721001	BOOM ASSY H20	OS	50405001	MAST H17 TANG	
40731001	BOOM CAP - H20 AFT		50406231	GOOSENECK H17	
40741021	BOOM CAP H20 FWD		50406261	GOOSENECK H17 UPDATE KIT	
40760001	BLOCK HANGER, H20		50406301	PIN H17 MAST STEP	
40770001	GOOSENECK PIN		50412001	MAST HEAD H17 BLACK	
40792001	WIRE SHROUD H20		50416011	MAST BASE H17/20/TIGER BLACK	
40810011	WIRE FORESTAY H20 UPR		50450001	ASSEMBLY MANUAL H17	
40822001	WIRE BRIDLE H20		50502201	ROLL PIN, GOOSENECK BOOM PIN	
40822121	WIRE FORESTAY H20 (5/16" END)		50504001	OUTHAUL WIRE ASSY H17	
40880011	RUDDER PIN H20 SS		50504101	OUTHAUL SLIDE H17	
40960005	WIRE BARBER HAULER H20		50510000	BOOM H17 BLACK O/S	OS
40970001	HIKING STRAP SET - H20		50511011	SPREADER POLE EXT. SPORT	OS
40970055	TRAMP H20 BLACK MESH		50512001	BOOM CAP H17 FWD BLACK	
40991000	SAIL H20 MAIN WHITE	OS	50513011	BOOM CAP H17 AFT BLACK	
40992010	SAIL H20 JIB WHITE	OS	50611101	COMPTIP H17	OS
40998000	SPINNAKER POLE/UNIVERSAL	OS	50650000	WING SET H17 W/O TRAMPS	OS
40998001	SPINNAKER BRIDLE WIRE H20		50650100	WING TRAMP H17 SET WHITE	
41010001	PLATE FWD INBOARD SUPPORT		50650900	WING TRAMP H17 SET BLACK	
41150001	FWD OUTBOARD SUPPORT TUBE H20		50650958	WING TRAMP H17 SET TURQ MESH	
41162001	HINGE/COVER PLATE H20 JIB		50660001	WING H17 LEFT T/F	OS
41170001	DOLPHIN STRIKER ROD H20	OS	50662001	WING CASTING H17 AFT BLK	
41180001	FWD INBOARD SUPPORT TUBE H20		50663001	WING CASTING H17 FWD BLK	
41190001	AFT XBAR SUPPORT TUBE 20/21SC		50665001	WING CAP H17	
41200001	MOUNT BRACKET H20 AFT #1		50666001	WING TUBE H17 INSIDE	OS
41210001	MOUNT BRACKET H20 AFT #2		50670000	TRAMP SET H17 WHITE	
41220001	EYELET POST		50670058	TRAMP SET H17 TURQ MESH	
41321001	TRAMP TRACK H20	OS	50670091	TRAMP SET H17 BLACK MESH	
41330031	JIB CAR W/O SLIDE STBD		50670301	TRAMP LACING AFT H17 WHT	
41330041	JIB CAR W/O SLIDE PORT		50670391	TRAMP LACING AFT H17 BLK	
41340001	DAGGERWELL CARPET KIT H20 (2)		50680001	WING H17 RIGHT	OS
41370001	HATCH SCREW-IN W/LIP-WHT 5"		50690001	PLUG WING SOCKET H17 BLK-4/PKG	
41390001	SPREADER ROOT FWD		50701101	WIRE BRIDLE H17 SE BLACK	
41400001	SPREADER ROOT AFT		50701201	WIRE FORESTAY H17 SE BLACK	
41410001	SPREADER TIP M20		50701501	TRAPEZE SHOCKCORD H17	
41420001	SPREADER ARM		50702001	HANDLE CENTERBOARD H17	
41430001	SPREADER BRACE		50772031	HINGE VERTEX GOOSENECK	
41440001	SPREADER SLIDE		51410000	MAST ASSY H17 SE/SPT '95	OS
41450001	SHIELD PLATE - TURNBUCKLE M20		52009001	SPREADER POLE END CAP SPORT	
41460001	TURNBUCKLE H20		52410011	HOOK-SPORT DOWNHAUL	
41461001	ANCHOR PLATE H20 DIAMOND WIRE		52411001	WASHER MAST BASE H17/20	
41661001	WIRE JIB HALYARD ASSY H20		52450011	ASSEMBLY MANUAL 17S	
41750001	WIRE DIAMOND ASSY H20		52500001	SPREADER POLE ASSY SPORT	OS
41820001	BRIDLE CONNECTOR PLATE		52500101	BRIDLE LWR SPORT (SS)	
41830001	JIB TACK PLATE		52500201	WIRE BRIDLE UPR SPORT	
41880001	TOGGLE H20 JIB HLYD SWVL		52502021	SPREADER POLE END CASTING	
41881011	TRAMP LACE ROD H20/H21SC 72"	OS	52503001	SPREADER POLE YOKE	
41890001	PIN SWIVEL 3/16		52661001	WIRE JIB HALYARD SPORT	
42000001	BATTEN SET H20	OS	52720011	TRAVELER ASSY SAIL FOOT	
42003001	JIB BATTEN H20 (8")		52721111	BALL MEDIUM 6 MM BLACK	
42011011	BATTEN H20 #1 (97.0")	OS	52722011	SPORT SAIL FOOT "BOOMLET"	
42021011	BATTEN H20 #2 (97.0")	OS	52812001	WIRE SPORT FORESTAY LWR	
42031011	BATTEN H20 #3 (93-1/2")	OS	52812011	WIRE SPORT FORESTAY UPR	
42041011	BATTEN H20 #4 (87")	OS	52991000	SAIL H17SE/SPT MAIN WHITE	OS
42051011	BATTEN H20 #5 (76")	OS	52991074	SAIL H17SE/SPT MAIN SMOKE	
42061011	BATTEN H20 #6 (60")	OS	52991991	SAIL H17SE/SPT MAIN SPEC	OS
42071011	BATTEN H20 #7 (47")		52992006	SAIL SPORT JIB WHITE DACR	
42081011	BATTEN H20 #8 (31")		52992023	SAIL SPORT JIB SPEC ORDER	
43450001	ASSEMBLY MANUAL-H20		52995610	SPORT JIB CONVERSION KIT	OS
47070041	CL236 CLAMCLEAT RACING JR		52995640	SE CONVERSION FROM SPORT	OS
48000001	HULL CRADLES H20 SET OF 4		53180011	HOG RING 3/8" S/S FOR 3/16" BU	
48010001	HULL CRADLES FOR BEACH		60060000	MAST FOAM PLUG H18	
48020001	BRACKET HULL CRADLE AFT		60102011	GUDGEON H18 CASTING KIT	
48030001	HULL CRADLES H20 FWD		60110000	MAST BEARING H18	
48040001	HULL CRADLES H20 AFT		60120000	TANG H18 BOW	
48661001	WIRE JIB HALYARD H20 FURL		60132010	CROSSBAR H18 EXT FWD BLK	OS
48814001	WIRE FORESTAY LWR H20 FUR		60140001	DOLPHIN STRIKER H18 POST	
48921001	ROLLER FURLER KIT H20		60150011	CROSSBAR H18 CSTG FWD LT BLK	
50101101	TRACK H17 TRAMPOLINE	OS	60160011	CROSSBAR H18 CSTG FWD RT BLK	
50101301	GUDGEON UPPER		60170011	MAST H18 STEP BLACK	
50101401	GUDGEON LWR		60180011	MAST H18 STEP ASSY BLACK	
50101701	ANCHOR BAR - SHROUD		60191211	CROSSBAR H18 AFT EXTR BLACK	OS
50102011	GUDGEON CASTING H16		60200011	CROSSBAR H18 CSTG AFT RT BLK	
50102101	CENTERBOARD CLEAT		60210011	CROSSBAR H18 CSTG AFT LT BLK	
50104001	CENTERBOARD PIVOT PIN H17		60220001	BOOM H18 OUTHAUL SL ASY	
50121511	CROSSBAR H17 INSERT (R)		60240000	BOOM H18 OUTHAUL BEARING	
50121611	CROSSBAR H17 INSERT (L)		60250000	BOOM PIN H18 OUTHAUL BRNG	
50212001	DOLPHIN STRIKER ROD	OS	60270000	FAIRLEAD H18 THRU-DECK	
50212101	DOLPHIN STRIKER POST H17		60300001	DAGGERBOARD H18	OS
50212201	DOLPHIN STRIKER H17 SLEEV		60309001	DAGGER WELL RETRO-KIT	
50212301	DOLPHIN STRIKER BALL H17		60330031	JIB SLIDE H18/20 (WITH 1/4-20	
50213201	CROSSBAR H17 INBOARD SUP		60330041	BLOCK HARKEN JIBSHEET	
50220000	CROSSBAR H17 ASSY FWD	OS	60331010	RUDDER CONV KIT H18 BLACK	
50221001	CROSSBAR H17/SPT EXT FWD	OS	60380111	TILLER ARM H18 STR BLACK	

60400011	RUDDER ADJUSTER KIT		68061001	WING LEG CSTG H18SX (SEAT END)
60450000	SCREW DELRIN RUDDER		68071001	WING CSTG H18SX (LT) SEAT SUPP
60460000	PIN-UPPER RUDDER HOUSING		68081001	WING CSTG H18SX (RT) SEAT SUPP
60550001	TILLER EXTENSION H18/21 (106")	OS	68091001	WING LEG H18SX FWD/LT
60602041	MAST HEAD H18 COMPTIP		68101001	WING LEG H18SX FWD/RT
60610010	MAST ASSY H18 BLACK	OS	68111001	WING LEG H18SX AFT/LT
60611100	COMPTIP H18	OS	68121001	WING LEG H18SX AFT/RT
60620000	SHEAVE 1"		68190001	ANCHOR PLATE, SX WINGS
60641031	MAST BASE CASTING H18		68302001	WIRE SET H18SX BLACK
60650011	MAST BASE HINGE CSTG H18		68330011	HEADBOARD ALUM W/RIVETS
60670000	SHACKLE, TWIST 3/16 PIN		68503501	TRAPEZE WIRE SX18 BLACK
60680001	COMPRESSION PLATE ASSY - MAST		68581000	MAST ASSY H18SX BLACK
60710000	GOOSENECK YOKE		68661001	WIRE H18SX JIB HALYARD
60720011	BOOM H18 BLACK	OS	68750001	WIRE H18SX DIAMOND
60730001	TRAPEZE SHOCK CORD H18		68793501	WIRE H18SX SHROUD BLACK
60730002	TRAPEZE SHOCKCORD W/HKS		68813501	WIRE H18SX FORSTAY UPR
60751010	BOOM CAP H18 FWD BLACK		68814501	WIRE H18SX FORSTAY LWR
60760011	BOOM CAP H18 AFT WHITE		68991100	SAIL H18SX MAIN WHITE
60790001	SHROUD H18/21SC WHITE		68992100	SAIL H18SX JIB WHITE
60792001	SHROUD H18/21SC BLACK		68999004	SPINNAKER 18/SX
60810011	WIRE H18/21SC FSTAY UPR		68999099	SPINNAKER H18SX CUSTOM
60810021	WIRE H18/21SC FSTAY WHT		70000111	BEACH DOLLY EURO H16
60812021	WIRE H18/21SC FSTAY BLK		71130001	HATCH SCREW-IN w/LIP-BLK 5"
60820001	WIRE H18 BRIDLE WHITE		71190011	HANDLE - LIFTING (WEB - BRAVO)
60822001	WIRE H18 BRIDLE BLACK		71220001	PAD EYE - CHROME
60830000	STAY ADJUSTER (FOR JIB FURLER)		71321001	GASKET KAYAK HATCH 6"
60880001	RUDDER PIN H17/18		71331001	GASKET KAYAK HATCH 8"
60880011	RUDDER PIN, ST. STEEL H17/18		71701011	HATCH 6" TWIST-N-SEAL
60970000	TRAMP SET H18 WHITE		71702011	HATCH 8" TWIST-N-SEAL
60970055	TRAMP SET, H18 BLK MESH		71703001	HOBBIE DRY BAG 8.0"
60970058	TRAMP SET H18 TURQ MESH		71997001	WATER BOTTLE MED SMOKE 18oz
60991011	SAIL H18 MAIN WHITE		71998001	WATER BOTTLE LARGE SMOKE 32oz
60991086	SAIL H18 MAIN CORONADO '08		71999011	WATER BOTTLE SMALL SMOKE 16oz
60992011	SAIL H18 JIB WHITE		72020001	HOBBIE GEAR KEEPER
60992071	SAIL H18 JIB TURQUOISE		72020010	HOBBIE SAFETY KIT
60992081	SAIL H18 JIB SILVER		72020030	TEAR-AID / TYPE A (POLY)
60998001	SPINNAKER BRIDLE WIRE H18		72020031	TEAR-AID / TYPE B (VINYL)
60999000	SPIN POLE & HRDWR KIT H18	OS	72089001	REDUCTION NOZZLE 3/8"
61010001	INBOARD SUPPORT CSTG H18 ASSY		72090001	WELDING GUN ASSY W/NOZZLE
61020001	INSERT NUT - INBD SUPT CSTG H1		72410001	DAGGERBOARD COVER TIGER/FOX/FX
61040001	INBOARD SUPPORT CSTG H18		79545001	DECAL, HOBBIE DOME, BLK/GRAY
61060001	DEAD EYE TRAVELER		80100501	SAIL FEEDER - HOBBIE
61070000	CLAMCLEAT JUNIOR CL203		80181001	YOKE TILLER CONNECTOR
61070010	CLAMCLEAT RACE JUNIOR		80200000	TURBO H14 JIB RIGGING KIT
61080000	MAST SEAL PLATE H18		80200010	DOLPHIN STRIKER KIT H14
61110000	CHANNEL - XBAR NUT UNDER LIP		80200020	TURBO H14 JIB UPDATE KIT
61120001	BACK UP CASTING - H18 BOW TANG		80201300	TURBO JIB BLOCK SUPPORT WIRE
61140000	SLEEVE DOLPHIN STRIKER		80242011	PLATE SS 1-5/8x 5/8
61170001	DOLPHIN STRIKER ROD H18	OS	80550005	BATTEN MAIN PKT PROTECTOR KIT
61210001	MAST ROTATION BAR		80660000	AUSSIE H16 JIB HALYARD KIT W/
61230000	SWIVEL JIB FURLER-EYE/EYE		82010001	BATTEN UNIVERSAL 107-7/8"
61260000	SHEAVE - JIB HALYARD BLOCK		82020001	BATTEN UNIVERSAL 82-3/8"
61290011	RING SS 3/16 X 1-3/16" ID		82030001	BATTEN UNIVERSAL 90-1/8"
61290021	HALYARD RING W/LOOP		82040001	BATTEN UNIVERSAL 42-11/16"
61310000	BLOCK MICRO SGL FIXED EYE		82060001	BATTEN UNIVERSAL 100 9/16"
61320001	TRAMP TRACK H18 PORT	OS	82070001	BATTEN UNIVERSAL 67-1/2" JIB (
61330001	TRAMP TRACK H18 STBD	OS	82080001	BATTEN UNIVERSAL 45" JIB
61370000	POP-IN DECKPLATE-FLANGE ONLY		82300001	HOBBIE STUFF
61380001	POP-IN DECKPLATE-COVER ONLY		82410001	COVER - DAGGERBOARDS H18
61382020	ACCESS PORT GASKET		82410020	COVER - DAGGERBOARDS H20
61410000	SPREADER ROOT		82420000	COVERS - RUDDER (PAIR)
61420000	SPREADER ARM H18		84430023	DVD - WAVE RIGGING
61430000	SPREADER BRACE		84430026	DVD- H14/H16 RIGGING -
61440000	SPREADER ARM SLIDE		84430027	VIDEO H17/SPT RIGGING - VHS
61480000	TANG DIAMOND WIRE		84430128	DVD - GETAWAY RIGGING
61490000	COMPRESSION SLEEVE H18		84430202	DVD - SHARING THE WIND, MOMENT
61510000	EYE STRAP		84430203	DVD - HOBBIE FILM FESTIVAL
61530000	ROPE LOCK		84430401	VIDEO CATAMARAN SAILING - DVD
61570000	THIMBLE 1/16" SS HVY DUTY		84430411	VIDEO TRAINING #1: BOAT HANDLI
61610101	HALYARD HOOK H18/20 COMPTIP		84430412	VIDEO TRAINING #2: UPWIND SAIL
61661001	WIRE JIB HALYARD ASSY H18		84430413	VIDEO TRAINING #3: GREAT START
61670000	BALL BEARING (18 PER FURLER)		84430414	VIDEO TRAINING #4: MARK ROUNDI
61711000	BOOM CLEAT CLAMP H18		84430415	VIDEO TRAINING #5: DOWNWIND SA
61740000	ROLLER DIAMOND WIRE H18		84430451	VIDEO CATAMARAN RACING - VHS
61750001	WIRE DIAMOND H18 W/TURNBUCKLE		86110000	DECAL - HCA COURSE CHART
61770000	TURNBUCKLE 1/8" FLAT JAW		86120000	DECAL - HCA RACING FLAGS
61800001	TRAVELER ASSEMBLY - MAIN		86200000	DECAL - RACE HCA FOR WINDOW
61810000	ROLLER SKID - TRAVELER		90170001	MAST STEP ASSY / BRAVO OLDER
61830000	BUSHING SHAFT - TRAVELER		90170011	MAST STEP ASSY / BRAVO NEWER
61842000	TRAVELER CAR BODY SUB ASSY		90312000	BRAVO EZ LOC RUDDER ASSY - REQ
61852000	BEARING SET (2 CYLINDERS)		90382011	TILLER ARM - BRAVO EZ LOC
61870000	TRAVELER DECK PLATE		90440011	PAD HIKING STRAP - BRAVO
61880000	SPACER H18 TRAVELER CAR		90440050	BLOCK LARGE BULLET
61890000	SHEAVE TRAVELER CAR		90500021	MAST KEEPER GATE ASSY
61900000	JIB FURLER ASSY		90501031	CSTG A-FRM CONNECTOR
61900900	FURLER TUNE UP KIT		90501036	FURLER LINE KEEPER STRAP ASSY
61910000	FURLER TUBE ROLLER		90502031	KNOB ASSY - MAST GATE
61920000	FURLER BEARING RACE		90550001	BRAVO TILLER EXTN ASSY "OLD ST
61930000	FURLER BEARING CAGE		90550011	BRAVO TILLER EXT - EZ LOC
61940000	FURLER NYLON SLEEVE 1" ID X 1.		90560020	TILLER END CAP BRAVO - OLDER
61950001	FURLER SLEEVE		90560041	TILLER END CAP BRAVO - EZ LOC
61960001	FURLER SPOOL&HOUSING		90600011	MAST FLOAT BRAVO (Q1026 & LWR
61980000	FURLER BRIDLE YOKE		90600012	MAST FLOAT BRAVO (Q1029 & UP +
62260001	CLAMCLEAT LEECHLINE CLEAT		90600021	SADDLE STRAP/BRAVO FLOAT
62270000	JIB CLEW PLATE (3 HOLE)		90600041	MAST FLOAT WEB STRAP/BUCKLE
62300000	ZIPPER JIB LUFF		90610101	COLLAR BRAVO MAST
62330000	DECAL H18 SAIL		90610111	DELRIN BALL 3/8 DIA - FURLERS
63450000	ASSEMBLY MANUAL H18		90611001	COMPTIP HOBBIE BRAVO
63780000	TRAMP LACING AFT H18 WHT		90612111	MAST BEARING - INJ MOLD
64100001	SHROUD ANCHOR PLATE KIT (PAIR)		90613000	MAST BRAVO LOWER T/F
64130001	RAIL REINFORCEMENT KIT H18		90640011	MAST BASE BRAVO
65030010	WING LEG CSTG H18SX (BOAT END)		90640021	BALL - MAST ROTATION
65071001	WING MOUNT KIT-SHORT BAR		90700011	WIRE BRAVO MAINSHEET ATTACHMEN
65100000	WING STRUT TAB H18		90700111	BLOCK FIDDLE RATCHET w/CAM BLA
68040255	WING TRAMP SX/21 SET BLK		90700121	BLOCK SINGLE w/BECKET BLACK
68060101	WING PARTS KIT H18SX		90700131	BLOCK RATCHET LOWER BRAVO (EZ

90700201	BRACKET MAINSHEET ATTACH - BRA		3856LG	HOBIE - FULL 3/2 LG BLACK	
90701001	A-FRAME REPLACEMENT KIT 2-PC		3856MD	HOBIE - FULL 3/2 MD BLACK	
90710000	A-FRAME SUPPORT w/STRAP -NEWER		3856SM	HOBIE - FULL 3/2 SM BLACK	
90710011	A-FRAME SUPPORT w/STRAP-OLDER		3856XL	HOBIE - FULL 3/2 XL BLACK	
90711011	A FRAME ATTACH-NEW STYLE 5/16"	OS	5018BK	HAT HOBIE "H" BLACK	
90720000	BOOM ASSY BRAVO		5018BL	HAT HOBIE "H" BLUE / GOLD	
90720101	GSNK BOOM CLIP - BRAVO	OS	5018GM	HAT HOBIE "H" GREY MESH	
90870000	BEACH DOLLY - BRAVO		5018RM	HAT HOBIE "H" RED MESH	
90880111	PINTLE UPPER BRAVO / OLDER		5018TG	HAT HOBIE "H" TAN w/ GREEN LOG	
90880211	PINTLE UPR - EZ LOC		5123LG	T-SHIRT LONGITUDE 33 (LG) GRAY	
90880221	PINTLE LWR - EZ LOC		5123MD	T-SHIRT LONGITUDE 33 (MD) GRAY	
90880231	RETAINER CLIP EZ LOC RDR HOUSI		5123XL	T-SHIRT LONGITUDE 33 (XL) GRAY	
90990010	SAIL BRAVO - SPIRIT		5124LG	T-SHIRT HOBIE CAT ANATOMY (LG)	
90991000	BAG MAST/SAIL BRAVO		5124MD	T-SHIRT HOBIE CAT ANATOMY (MD)	
90992000	BAG SAIL BRAVO (SAIL ONLY)		5124XL	T-SHIRT HOBIE CAT ANATOMY (XL)	
91011011	BRAVO BATTEN #1 (5' 6 1/2")		5126LG	T-SHIRT LONGITUDE 33 (LG) WHT	
91021111	BRAVO BATTEN #2 (11' 6 5/8")		5126MD	T-SHIRT LONGITUDE 33 (MD) WHT	
91031011	BRAVO BATTEN #3 (10')		5126XL	T-SHIRT LONGITUDE 33 (XL) WHT	
91050010	HOOK WHT NYLON SEW-ON		5127LG	T-SHIRT REGATTA LG	
91281000	DRAIN SCREW W/WASHER H9/12/WV/		5127MD	T-SHIRT REGATTA MD	
91490010	BRACKET H18 SX WING LEG STRUT		5127XL	T-SHIRT REGATTA XL	
96280000	SLUG SLIDE 5/16" NYLON		5128LG	T-SHIRT SUNSET LG	
1376LG	HARNESS AUTOMATIC LG		5128MD	T-SHIRT SUNSET MD	
1376MD	HARNESS AUTOMATIC MD		5128XL	T-SHIRT SUNSET XL	
1376SM	HARNESS AUTOMATIC SM		5351B	HATCH COVER KIT 5" BLACK	
1376XL	HARNESS AUTOMATIC XL		5351W	HATCH COVER KIT 5" WHITE	
1378LG	HARNESS CONVERTIBLE LG		5352B	HATCH COVER KIT 4" BLACK	
1378SM	HARNESS CONVERTIBLE S/MD		5352W	HATCH COVER KIT 4" WHITE	
1378XL	HARNESS CONVERTIBLE XL		5353B	HATCH COVER KIT 6" BLACK	
1388LG	SKIPPERS HARNESS LARGE		5353W	HATCH COVER KIT 6" WHITE	
1388MD	SKIPPERS HARNESS MEDIUM		72000B	POUCH GUSSETED 6x12	
1388SM	SKIPPERS HARNESS SMALL		72005B	POUCH SUPER GUSSETED 8x15	
1388XL	SKIPPERS HARNESS X LARGE		72210T	SEE BAG 8" X 14"	
1470B	TRAP WIRES WAVE BLK		72230T	SEE BAG 11" x 19"	
1471B	TRAP WIRES H16/17 BLK		80000B	BACKPACK W/HOBIE LOGO	
1471W	TRAP WIRES H16/17 WHT		80000R	ROLLING DUFFLE/SUITCASE	
1472B	TRAP WIRES H16 BLK W/SHCK		80035A	ANCHOR w/BAG & LINE (3 LB)	
1472W	TRAP WIRES H16 WHT W/SHCK		B094	SWIVEL SHACKLE	
1473B	TRAP WIRES H18 BLK (ONE SIDE)		B323	BULLSEYE W/FERRULE	
1473W	TRAP WIRES H18 WHITE		CL212A	JIB HALYARD CLEAT SHIELD	
1474B	TRAP WIRES H18 BLK W/SHCK		CL247	COMPACT 3 SHEAVE CLEAT	
1474W	TRAP WIRES H18 WHT W/SHCK		CM7703	BRIDLE VANE - STANDARD	
1475B	TRAP WIRES H14 BLK		CM7704	VANE REPLACEMENT	
1476B	TRAP WIRES H14 BLK W/SHCK		CM7705	BRIDLE VANE ADAPTOR - FURLER	
1478B	TRAP WIRES GETAWAY BLK		CM7732	L'L SISTER CLIPS	
1553CR	CROAKIES "HOBIE"		F14061105	PLUNGER - CAM TIGER	
1553L	LID LEASH MULTI-COLOR		F14061106	PLUNGER TIGER	
1562BLK	SUNGLASS HOBIE PLAYA BLACK		F14061122	CAM STOP PLATE	
1563BLK	SUNGLASS HOBIE O'SIDE BLACK		F14061180	CAM RUDDER TIGER	OS
1671BLK	RAIL RUG KIT BLACK - H14/16		F16032110	SPINNAKER H16 TRUMPET	
1825LID	LID TOYBOX FWD - FIBERGLASS	OS	F16041755	TIGER CAM PIN	
1825WHT	TOYBOX (TRUCK FREIGHT)		F16056025	TIGER SPIN. POLE CONNECTOR	
2004BLK	J & H HANDLES-BLACK		F17000010	UPPER RUDDER CSTING TIGER	
2004WHT	J & H HANDLES-WHITE		F17062680	RUDDER CASTING LOWER HCE	
314-13ALL	COVER UNIVERSAL UP TO 13' WAVE		F18012817	BOOM TIGER '03	
314-14TO17	COVER UNIVERSAL 14'-17'		F18025840	TRAMP TIGER BLACK MESH	
314-16-GTWY	COVER GETAWAY		F18030196	SPINNAKER TIGER YELLOW	
314-17TO18	COVER UNIVERSAL 17'-18'		F18030198	SPINNAKER YELLOW TIGER 19m	
314-19TO20	COVER UNIVERSAL 19'-20'		F18030199	SPINNAKER TIGER RED	OS
3185LG	GLOVES - FINGERLESS LARGE		F18030245	SAIL TIGER MAIN STX SMOKE	OS
3185MD	GLOVES - FINGERLESS MEDIUM		F18030265	SAIL TIGER MAIN STX WHITE	
3185SM	GLOVES - FINGERLESS SMALL		F18030291	SPINNAKER TIGER WHITE	
3185XL	GLOVES - FINGERLESS X-LARGE		F18030295	SPINNAKER TIGER BLUE	OS
3185XS	GLOVES - FINGERLESS X-SMALL		F18030400	SAIL TIGER JIB BATTENED WHITE	OS
3185XXS	GLOVES - FINGERLESS XX-SMALL		F18030410	SAIL TIGER JIB BATTENED SMOKE	OS
3186LG	GLOVES - 3 FINGER LARGE		F18034200	TIGER BATTEN SET S.T.X.	
3186MD	GLOVES - 3 FINGER MEDIUM		F18042712	HALYARD RING-EURO	OS
3186SM	GLOVES - 3 FINGER SMALL		F18042755	MAST ASSY TIGER '03	OS
3186XL	GLOVES - 3 FINGER X LARGE		F18050905	DAGGERBOARD TIGER	
3186XS	GLOVES - 3 FINGER X SMALL		F18056005	GUDGEON TIGER W/BUSHING	
3186XXS	GLOVES - 3 FINGER XX SMALL		F18056012	GUDGEON, TIGER UPR '07	
3187LG	GLOVES - FULL FINGER LARGE		F18056014	GUDGEON, TIGER LWR '07	
3187MD	GLOVES - FULL FINGER MEDIUM		F18060301	ROPE LOCK SINGLE	
3187SM	GLOVES - FULL FINGER SMALL		F18060508	WIRE SHROUD TIGER	
3187XL	GLOVES - FULL FINGER X LARGE		F18060515	WIRE FORESTAY 18TI	
3187XS	GLOVES - FULL FINGER X SMALL		F18060555	JIB HALYARD WIRE HC18TI	
3187XXS	GLOVES - FULL FINGER XX SMALL		F18060565	DIAMOND WIRE TIGER	
3188LG	GLOVES HOBIE LARGE		F18060572	WIRE TRAPEZE TIGER PR.	
3188MD	GLOVES HOBIE MEDIUM		F18061579	WIRE BRIDLE 18TI BLK	
3188SM	GLOVES HOBIE SMALL		F18062160	TILLER ARM, TIGER	OS
3188XL	GLOVES HOBIE X LARGE		F18062261	TILLER X-BAR TIGER	OS
3252W	WIRE COVERS 1/8" WHITE		F18062645	SPINNAKER POLE-TIGER	OS
3253W	WIRE COVERS 5/32" WHITE		F18062990	WING SET TIGER COMFORT	
3261B	SHROUD ADJ COVERS BLK 12" PAIR		F21060056	BALL SET 74PC	
3850LG	HOBIE SPRAY TOP LG		F21062673	TIGER STEP BALL	
3850MD	HOBIE SPRAY TOP MD		F21080335	RUDDER PIN TIGER	
3850SM	HOBIE SPRAY TOP SM		F99064050	SPREADER ASSY TIGER '03	
3850XL	HOBIE SPRAY TOP XL		F99220004	TIGER RUDDER SPRING	
3851LG	HOBIE RASHGUARD - SS LG		F99220006	TIGER CAM TENSION SCREW	
3851MD	HOBIE RASHGUARD - SS MD		F99220009	NUT D10	
3851XL	HOBIE RASHGUARD - SS XL		F99220113	BUSHING RUDDER PIN	
3852LG	HOBIE RASHGUARD - LS LG		F99220132	HEART SHACKLE (Downhaul/Tiger)	
3852MD	HOBIE RASHGUARD - LS MD		F99220208	END CAP D40	
3852XL	HOBIE RASHGUARD - LS XL		F99220685	RUDDER SPRING	
3853LG	HOBIE - SHORTY 2/2 LG RED/BLK		F99220710	WASHER NYLON D20x10	
3853MD	HOBIE - SHORTY 2/2 MD RED/BLK		F99220855	SCREW TC 5x40	
3853SM	HOBIE - SHORTY 2/2 SM RED/BLK		F99220880	SCREW TH 8x60/22	
3853XL	HOBIE - SHORTY 2/2 XL RED/BL		F99226001	GUDGEON SCREW (EURO)	
3854LG	HOBIE - FULL 3/2 LG RED/BLK		F99267522	SOFT TRUMPET BAG ONLY	
3854MD	HOBIE - FULL 3/2 MD RED/BLK		F99267585	TIGER COVER	
3854SM	HOBIE - FULL 3/2 SM RED/BLK		F99501200	DAGGERBOARD HOLD DOWN KIT	
3854XL	HOBIE - FULL 3/2 XL RED/BLK		F99502230	RUDDER BLADE TIGER	
3855LG	HOBIE - SHORTY 2/2 LG BLACK		F99502280	RUDDER BLADE, TIGER '07	
3855MD	HOBIE - SHORTY 2/2 MD BLACK		F99600010	SPINNAKER BALE KIT EURO	
3855SM	HOBIE - SHORTY 2/2 SM BLACK		FX3	HOTSTICK 52"-96"	OS
3855XL	HOBIE - SHORTY 2/2 XL BLACK		FX4	HOTSTICK 57"-105"	OS

FX6	HOTSTICK MAGNUM 63"-120"
FXGRIP	GRIP BALL KIT - HOTSTICK
H001	BLOCK SINGLE 2.25"
H002	BLOCK SINGLE W/BKT 2.25"
H004	BLOCK-2.25" DOUBLE W/BKT
H007	BLOCK DOUBLE 3.00"
H019	BLOCK-2.25" HEX STBD
H023	BLOCK-1.75" DINGHY SWVL
H048	BLOCK TRIPLE 2.25
H049SP	BLOCK TRIPLE 3.00"
H053	BLOCK 2.25" FIDDLE
H060	BLOCK 2.25" FIDDLE HEX
H065	BLOCK TRIPLE 2.25 W/BECKET/PO
H071	SPRING-STANDUP
H072	SHACKLE-3/16" W/PIN & RING
H076	BLOCK-2.25" TRPL W/BKT
H082	BLOCK-SINGLE BULLET
H083	BLOCK-BULLET W/BECKET
H084	BLOCK-BULLET DOUBLE
H092	BLOCK-BULLET CHEEK
H097	STAND UP SPRING-SMALL
H099	BLOCK-BULLET W/BCKT (HI LOAD)
H125	BLOCK-BIG BULLET
H126	BLOCK-BIG BULLET W/BECKET
H137	EYESTRAP-LARGE SS
H138	SHACKLE ASSY-1/4" SS
H145	CAM-MATIC WEDGE KIT
H150	CAM CLEAT-CAM MATIC ALUMINUM
H153	BLOCK-2.25" LP SWVL W/POST
H159	TRAVELER CAR-SB HL W/FIXED
H160	SHEAVE-BULLET
H166	BLOCK-BULLET SWIVEL
H167	BLOCK-BULLET SWIVEL W/BECKET
H168	BLOCK-BIG BULLET SWIVEL
H170	BLOCK-3" HEXCAT BASE W/CAM
H171	RED CAR W/SHACKLE & SWVL
H174	END STOP-SB HI BEAM (2)
H177	BALLS-1/4" TORLON (20)
H186	BLOCK-2.25" W/CAM & BKT
H188	BLOCK-2.25" HEX W/CAM & BKT
H194	BLK-2.25" LO PRO TRIPLE HEX
H201	EYESTRAP-LO PRO SS
H205	CAM BASE-SMALL SWIVEL
H224	BLOCK-MICRO SINGLE
H225	BLOCK-MICRO W/BECKET
H225S	DOWNHAUL, SINGLE MICRO
H226	BLOCK-MICRO DOUBLE
H226S	DOWNHAUL, DBL MICRO
H227	BLOCK MICRO DOUBLE W/BKT
H228	BLOCK-MICRO TRIPLE
H231	BLOCK-MICRO TRIPLE W/CAM
H232	BLOCK-MICRO TRAVELER
H233	BLOCK-MICRO CHEEK
H237	BULLSEYE FAIRLEAD
H244	BLOCK MICRO FIDDLE W/V-JAM
H2640	TRIPLE 40mm CARBO BLOCK
H281	EYESTRAP-MICRO SS
H284	KIT-MICRO WIRE FAIRLEAD
H285	SAIL CHAFE PROTECTOR SET
H291	BLK-BULLET PIVOT EXIT W/CAM
H291S	CLEAT SWIVEL CONTROL ASSY W/ L
H297	WEDGE KIT-MICRO CAM
H298	FAIRLEAD-KIT-CAM-MATIC WIRE LG
H300	BLOCK-1" WIRE
H328	FAIRLEAD-REV CAM
H329	FAIRLEAD-MICRO REV CAM
H350	29mm CARBO CHEEK
H353	BLOCK-BULLET TRAVELER
H365	CAM CLEAT-PL HI PERFORMANCE LP
H404	BLOCK-16MM AIR FXD SGL
H405	BLOCK-16MM AIR FIXED SGL W/BKT
H406	BLOCK-16MM AIR FIXED DOUBLE
H407	BLOCK-16MM AIR FIXED DBL W/BKT
H423	CAM CLEAT-MICRO CARBO
H427	CAM-MICRO CARBO W/FAIRLEAD
HFS100	SCREW 8-32 X .188 18-8 SLTR
HSB78	END CAP SET - TRAVELER CAR
HSPAP	SCREW 1/4-20 X 3/4 THMS-P SS
R359P	LANCE CLEAT PORT
R359S	LANCE CLEAT STBRD
RF05BW	LINE ROBLINE RACE 5MM BLUE/WHT
RF08BLU	LINE ROBLINE RACE 8MM BLUE/WHI
RF10GRY	LINE ROBLINE RACE 10MM GRAY
RF4030	RONSTAN CLEARSTART WATCH
RF5001	CAM CLEAT SM RED
RF5004	SMALL ROPE GUIDE
RF5005	SMALL "FAST TRACK" FAIRLEAD
RF5011	CLEAT CAM RONSTAN
RF5015	MEDIUM "FAST TRACK" FAIRLEAD
RF5016	CURVED SURFACE ADAPTER
RF56101	BLOCK SERIES 55 AUTO RATCHET
RH014WHT	LINE 1/4" STRAIT-CORE POLY
RH018WHT	LINE 1/8" NYLON BRAID WHITE
RH038WHT	LINE 3/8" STRAIT-CORE POLY
RH112WHT	LINE 1/12" NYLON BRAID WHITE
RH316WHT	LINE 3/16" STRAIT-CORE POLY
RH516WHT	LINE 5/16" STRAIT-CORE POLY
RL012BLU	LINE 1/2" HOLLOW BRAID BLU/WHT
RM014BLK	LINE 1/4" SPUN DACRON - BLACK
RM014BLU	LINE 1/4" SPUN DACRON - BLUE
RM014RED	LINE 1/4" SPUN DACRON - RED
RM014WHT	LINE 1/4" SPUN DBL BRD - WHITE
RM038BLK	LINE 3/8" SPUN DACRON - BLACK
RM038BLU	LINE 3/8" SPUN DACRON - BLUE
RM038RED	LINE 3/8" SPUN DACRON - RED
RM038WHT	LINE 3/8" SPUN DBL BRD - WHITE

RM516BLK	LINE 5/16" SPUN DACRON - BLK
RM516BLU	LINE 5/16" SPUN DACRON - BLUE
RM516RED	LINE 5/16" SPUN DACRON - RED
RM516WHT	LINE 5/16" SPUN DBL BRD-WHITE
RM716BLK	LINE 7/16" SPUN DACRON - BLACK
RM716BLU	LINE 7/16" SPUN DACRON - BLUE
RM716RED	LINE 7/16" SPUN DACRON - RED
RM716WHT	LINE 7/16" SPUN DACRON - WHITE
RS014BLK	SHOCKCORD 1/4" BLACK
RS018BLK	SHOCKCORD 1/8" BLACK
RS038BLK	SHOCKCORD 3/8" BLACK
RS316BLK	SHOCKCORD 3/16" BLACK
RS516BLK	SHOCKCORD 5/16" BLACK
RS716BLK	SHOCKCORD 7/16" BLACK
RY038RB	LINE 3/8" YALE LIGHT PUR/YEL
S6142LG	PFD WEDGE-E STQUIST LG
S6142MD	PFD WEDGE-E STQUIST MD
S6142SM	PFD WEDGE-E STQUIST SM
S6142XL	PFD WEDGE-E STQUIST XL
S6142XXL	PFD WEDGE-E STQUIST XXL
S6143LXL	PFD HI-BACK ZIP MANGO LXL
S6143SMD	PFD HI-BACK ZIP MANGO SMD
S6143XXL	PFD HI-BACK ZIP MANGO XXL
S6144LXL	PFD HI-BACK ZIP GREEN LXL
S6144SMD	PFD HI-BACK ZIP GREEN SMD
S6144XXL	PFD HI-BACK ZIP GREEN XXL
S6145LXL	PFD HIBACK MANGO LXL-ULC
S6145SMD	PFD HIBACK MANGO SMD-ULC
S6146MLG	PFD HI-BACK P-BLUE (W) MLG
S6146PS	PFD HI-BACK P-BLUE (W) PS
S6146XSS	PFD HI-BACK P-BLUE (W) XSS
S6779RG	PFD INFLATABLE RED/GRAY
S6779TG	PFD INFLATABLE TAN/GRAY
SBV3120YEL	PFD CHILD (30-50LB) RED
SBV3122YEL	PFD YOUTH (50-90LB) RED
SP150041	SHACKLE 5/32 X 3/8 X 5/8
SP150051	SHACKLE 3/16x1/2x11/16
SP150052	SHACKLE 3/16 x 5/8 x 5/16
SP150053	SHACKLE 3/16 X 5/8 X 1-7/16
SP150061	SHACKLE 1/4x9/16x15/16
SP150081	SHACKLE 5/16x11/16x13/16
SP170005	SHACKLE TWISTED SS 3/16
SP170006	SHACKLE TWISTED SS 1/4
SP180004	SHACKLE KEY PIN 5/32"
SP180005	SHACKLE KEY PIN 3/16"
SP180006	SHACKLE KEY PIN 1/4"
SP185203	SHACKLE KEY PIN 3/16"
V1093	SCREW-IN DECKPLATE 5" CRVD WH
V1100	SCREW-IN DECKPLATE 5" CRVD BLA
V1130	SCREW-IN DECKPLATE 4" CRVD WH
V1131	SCREW-IN DECKPLATE 4" CRVD BL
V1145	SCREW-IN DECKPLATE 6" WHITE W
V1146	SCREW-IN DECKPLATE 6" BLACK W/

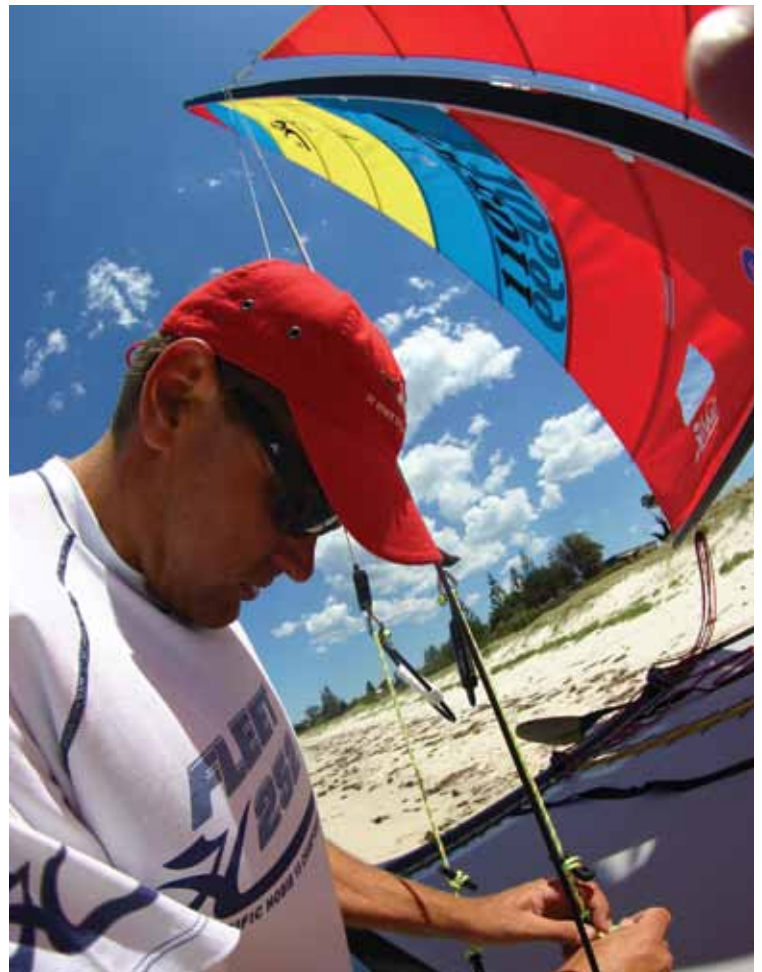

designed by nature,
PERFECTED by HOBIE



Introducing the
Hobie Mirage Island

HOBIE
Mirage Drive

Patented Mirage Drive
pedal system propels
you fast and quietly.

Choose
your
adventure!

Hobie **mirage** *Adventure*

Capacity: 350 lbs / 159 kg Length: 16' / 4.88 m Width: 27.5" / 0.70 m Hull Weight: 62 lbs. / 28.12 kg. MirageDrive Weight: 6.6 lbs. / 3 kg.

HOBIE

1 (800) Hobie - 49 hobie kayaks.com

PRODUCT	PAGE	PRODUCT	PAGE	PRODUCT	PAGE	PRODUCT	PAGE
ADJUSTABLE TRAPEZE SYSTEMS	8	DOUBLE GROMMET KIT	17	MAIN cont.		SOLO RIGHTING SYSTEM	18
AIR BLOCKS	24	DOWNHAUL SCALE	25	BLOCKS	23	SPARE PARTS BAGS	27
ALL PURPOSE TOOL	38	DOWNHAUL SHEAVE	25	OVERBOARD PREVENTER	17	SPINNAKERS	13
ANTI CHAFE SAIL TAPE	15	DOWNHAUL SYSTEMS	25	SAIL COVERS	33	BAGS	13
ANTI PITCH POLE HYDRO FOIL	18	DUFFEL BAG	34	SAILS	17-Nov	POLE AND RIG KIT	13
ASSEMBLY MANUALS	40	DWYER WIND METER	16	SHEET	28	SPORT CONVERSION KIT, H17	12
AUSSIE HALYARD RING	25	EASY RIG HANDLES	38	SHEET SYSTEMS	23	SPORTS BOTTLE	3
AUSSIE JIB HALYARD	25	EASY RITE	18	TRAVELER CARS	22, 25	SPRAY SUIT TOP	4
AUTO RATCHET BLOCKS	24	EASY UP	18	MAST		SPRAY SUIT FULL	5
BABY BOB	19	EPOXY	39	BABY BOB FLOAT	19	SPREADER BAR END COVERS	15
BACK REST-WAVE	10	EYESTRAPS	23	CRADLES	32	SPUN DACRON LINE	28
BAGS		EZ STEP	31	EZ STEP	31	STARBRITE POLISH	39
BACK PACK	34	FAIRLEADS	22	FLOATS	19	STORAGE BAGS	33-35
GEAR	34	FAST SHACKLES	26	SEALANT	39	STORAGE BOX	30
HATCH	35	FIBERGLASS COLOR RESTORER	39	STEP BEARINGS	37	SUNGLASSES	3
SPINNAKER	13	FIDDLE BLOCKS	8, 25	STEPPER	31	SWAGE TOOL	38
TRAMP	34	FOOT STRAPS	9	STEPPER II	31	SWIVEL CAM CLEATS	22
BALL LOCK PINS	21, 27	FSR	39	MESH TRAMPOLINES	17	SWIVEL SHACKLES	26
BALL TIES	31	FULL HARNESSSES	7	MICRO BLOCKS	24	T-SHIRTS	2
BATTENS	14	FURLING JIBS	12	MOTOR MOUNTS	37	TELESCOPING PADDLE	37
CAPS	15	GEAR BAG	34	MOUNTING PLATE	22	TELL TALES	16
DRAFT GAUGES	15	GEL COAT REPAIR	39	MULTI-PLIER	38	TELO CAT BRIDLE VANE	16
HINGE	15	GLOVES	36	IHCA (HOBIE CLASS ASSOC.)	41	THE SNORKEL	33
POCKET PROTECTORS	15	GOOSENECK BEARING	25	NEOPRENE RAIL KIT	9	THIRD HAND	21
TENSIONER	15	GROMMET KIT	17	NON SKID	9	THREE WAY ROLLER FAIRLEAD	22
BEACH WHEELS	32	GUDGEON SCREWS	20	ONE WRAP VELCRO	28	TIE DOWN STRAPS	31
BLOCKS		GUDGEONS	20	PADDLE	37	BLUE TRAX	32
AIR	24	HALF HARNESSSES	7	PINS	27	TILLER CONNECTION KIT	21
AUTO RATCHET	24	HALYARD		PLIERS	38	TILLER GRIPS	21
BULLET	24	AUSSIE	25	POCKET KNIVES	38	TILLERS	21
CHEEK	24	GRIP	25	POLISH	39	TOOLS	38
FIDDLE	8, 24	RING	25	PORT HULL COVERS	35	TOY BOX	30
HARKEN	22, 25	SHACKLES	26	QUICK RELEASE PINS	27	TRAILER	30
JIB	22	SHEAVE	25	RACING RULES-BOOK	40	TRAILER BOX	30
MAIN	23	HAND WINCH	31	RAIL RUG KIT	9	TRAMPOLINE	
MICRO	24	HANDLES, TRAPEZE	8	REMOVABLE SHEAVE BLOCK	9	BAGS	34
BOAT COVERS	32	HARKEN		RIGGING VIDEOS	40	CLEANER	39
BOAT TIE DOWNS	31	CAM CLEATS	22, 23	RIGHTING		DOUBLE GROMMET KIT	17
BOOKS	40	EYESTRAPS	23	EASY RIGHT	18	LACING KIT	17
BOOM BAGS	33	FAIRLEADS	22, 23	EASY UP	18	MESH	17
BOOM VANG	25	JIB FURLER SYSTEMS	12	MAST FLOATS	19	TRAMP CLAMP	17
BOOMLET, H17	12	LARGE BLOCKS	23	RIGHTING BUCKET	18	VINYL	17
BOW SHACKLES	26	SMALL BLOCKS	24	SHROUD EXTENDER	18	TRAP SEAT	10
BRIDLE FLIES	16	WEDGES	23	SOLO	18	TRAPEZE	
BUCKLES	7	HARNESSES	7	ROLLER FAIRLEADS	22	ADJUSTMENT KITS	8
BULLET BLOCKS	24	HARNESSES	7	ROLLER FURLING SYSTEMS	12	BUCKLES	7
BUNGEE CORD	28	HAT LEASH	2	ROPE LOCK	9	DOGBONES	8
BUSHINGS	20	HATCH BAGS	35	RUDDER		HANDLES	8
CABLE CUTTER	38	HATCH COVER KIT	35	BLADES	20	HARNESSES	7
CAM CLEATS	22	HATS	2	CAM KIT	21	HOOKS	7
CARPET RAIL KITS	9	HIKING STICK GRIPS	21	CAM SISTER SCREWS	21	RETURN SYSTEM	9
CAT BAGS	35	HIKING STICKS	21	CASTING BUSHINGS	20	SPREADER BARS	7
CAT BOX	30	HOBIE MAMA BOB	19	COVERS	33	TRAP STAYS	9
CAT CREWING-BOOK	40	HOBIE FILM FESTIVAL-VIDEO	40	DING REPAIR	39	WIRES	8
CAT KEY	38	HOBIE TOOL	38	GUDGEONS	20	TRAVELER CARS	22, 25
CAT RACING-VIDEO	40	HOG RING PLIERS	38	KICK BACK KIT	21	TRENTEC JIB TRAVELER CAR	22
CAT SAILING-BOOK	40	HOT STICKS	21	PINS	20	TRENTEC SUPER GOOSE	25
CAT SAILING-VIDEO	40	HULL CLEANERS	39	STIFFENING KIT	21	TRENTEC TRAMP CLAMP	17
CAT TRAX	32	HULL CRADLES	30, 32	SAFETY SHACKLES	26	TWIST SHACKLES	26
CAT WHEELS	32	JIB		SAILING DRILLS-BOOK	40	TWO PART EPOXY	39
CHEEK BLOCKS	24	AUSSIE HALYARD	25	SAILS	11-16	VELCRO	28
CHILD'S LIFE JACKETS	6	BATTENS	14	BAGS	33	VIDEOS	40
CLEANERS	39	BLOCKS	22	CHAFE PROTECTORS	15	VINYL CLEANERS	39
CLEATS	22, 25	CHAFE PROTECTORS	15	COVERS	33	RUST REMOVER	39
CLEVIS PINS	27	FURLING SYSTEMS	12	FEEDERS	25	VINYL TRAMPOLINES	17
COLOR RESTORER	39	SAILS	16-Nov	REPAIR	15	WATER BOTTLE	3
COMP TIP COVERS	33	SHEET	28	SAVER	15	WATERPROOF BAGS	35
CONVENIENCE PARTS	27	SNORKEL	33	BRAVO, WAVE	11	WAVE	
CONVERSION KIT, H17SE TO SP	12	SPORT CONVERSION KIT	12	14, 16, 18, GETAWAY	11	GEAR BAGS	33
CONVERSION KIT, H17SP TO SE	12	TRAVELER CARS	22	SEALANT, MAST	39	JIB KIT	12
CORK BALL GRIP	21	TRAVELER CONTROL KITS	22	SEALANT, SILICONE	39	MAST CRADLES	31
COVERS		KEEPER PINS	27	SHACKLES	26	MAST STAND	30
BOAT	30	KEY FLOATS	3	SHARING THE WIND-VIDEO	40	SAILS	11
BOOM	33	KICK BACK KIT	21	SHEAVES	25	TRAILER	30
COMPTIP	33	KNIVES	38	SHIRTS	2	WHEELS, BEACH	32
DAGGERBOARD	33	LANCE CLEATS	22	SHOCKCORD	28	WINCH	31
RUDDER	33	LEECH CAPS	15	SHOCKCORD BALL TIES	31	WIND INDICATORS	16
SAIL	33	LICENSE PLATE FRAMES	3	SHOCKCORD SNAP HOOKS	28	WIND METERS	16
THE SNORKEL	33	LIFE JACKETS	6	SHROUD ADJUSTER COVERS	37	WIND VANES	16
CROAKIES	3	LIL SISTER CLIPS	25	SHROUD EXTENDER	18	WINGS	10
D-SHACKLES	26	LINE	28	SILICONE SEAL	39	WIRE	
DACRON LINE	28	LOW STRETCH LINE	28	SILICONE SPRAY	39	COVER	28
DAGGERBOARD COVERS	33	LUFF CAPS	15	SISTER CLIPS	25	CUTTER	38
DECK PORTS	35	LYCRA TOP	4	SNAP HOOKS	28	TRAPEZE	8
DING REPAIR	39	MAIN		SNAP SHACKLES	26	WETSUIT	4-5
DOGBONES	8	BATTENS	14	SNORKEL JIB COVERS	33		

HOBIE CAT COMPANY
Oceanside, California U.S.A.
1-800-HOBIE-49
hobiecat.com

HOBIE CAT AUSTRALASIA
Huskisson, New South Wales Australia
1-800-4-HOBIE
hobiecat.com.au

